

**ALLEMAAL
YIELEYAAL**

Tekening: Situatie Fase 5-6
 Woningtype: _____
 Bouwnummer: _____
 Bladnummer: VT-S-01
 Schaal: 1:1000
 Datum: 30-01-2024

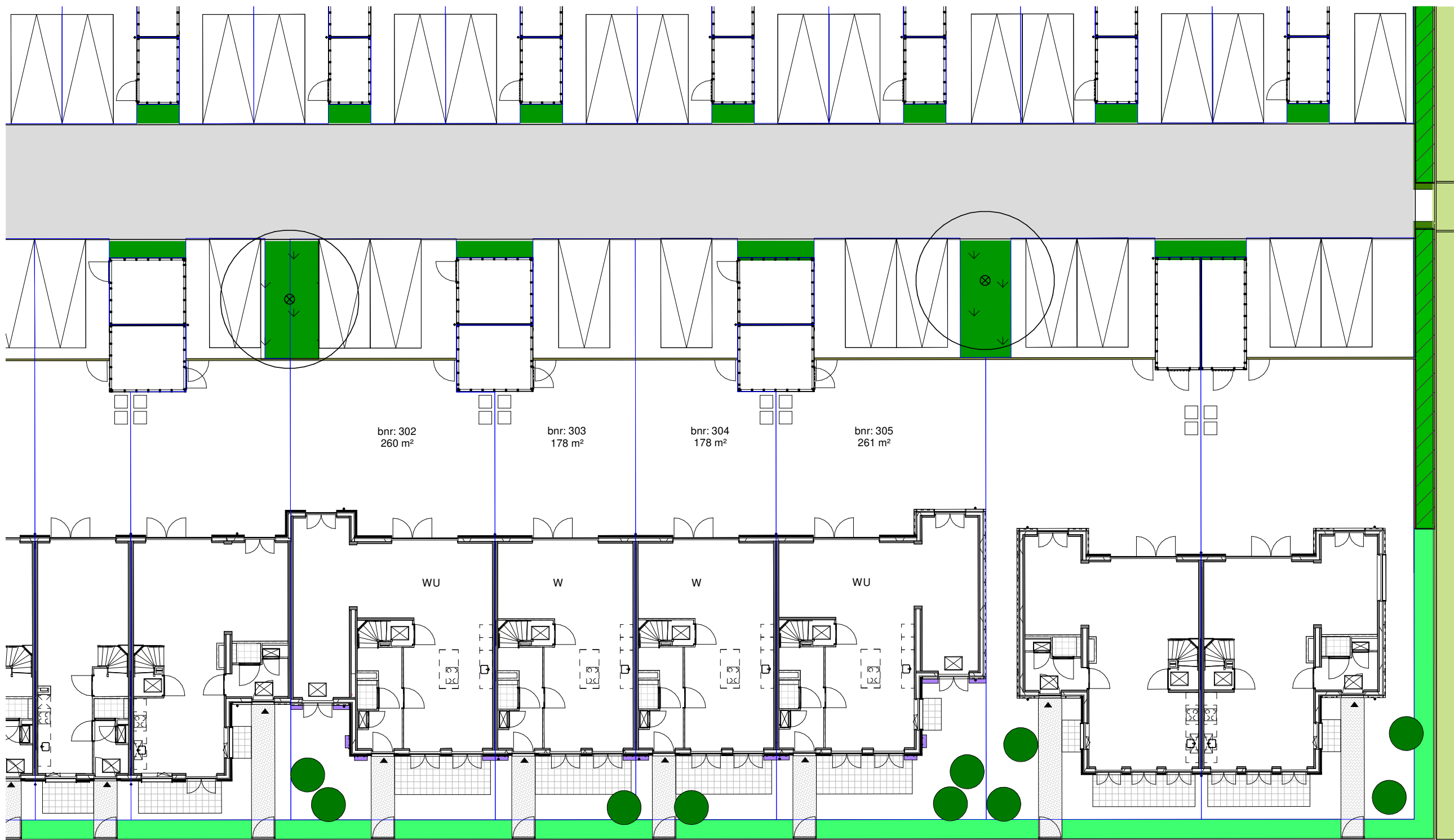

Renvooi

-  - entree woning
-  - parkeervak eigen terrein
-  - erfgrans
-  - struik type n.t.b. koper
-  - opstelplaats klike
-  - tuinhekje
-  - klinkerbestrating
-  - betontegels 300x300mm
-  - groen strook
-  - haag h=900mm
-  - haag h=1800mm
-  - bamboehok h=1800mm
-  - gaashek met klimplanten en poort h=1600mm
-  - klimplant



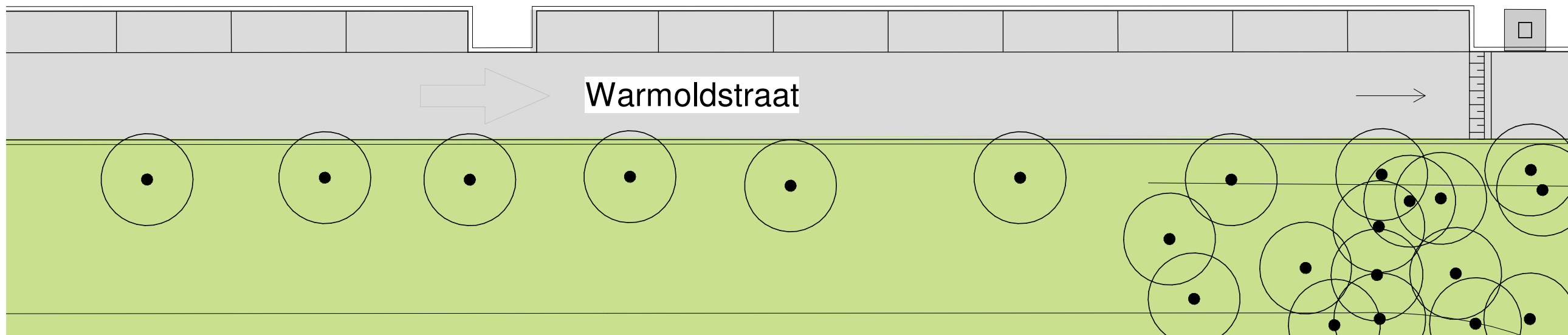







parkeerplekken en posities bomen en struiken zijn indicatief



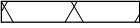

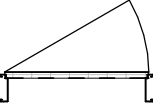
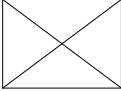



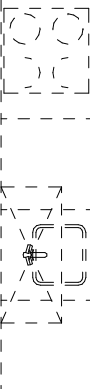





















**ALLEMAAL
YIELEYAAL**

Tekening: Situatie Blok L5
 Woningtype: WU, W
 Bouwnummer: 302-305
 Bladnummer: VT-S-03
 Schaal: 1:200
 Datum: 30-01-2024

Renvooi bouwkundig

	metselwerk kleur A
	dakpannen kleur oranje
	entree woning
	metselwerk
	isolatie
	dragende wand
	niet dragende binnenwand
	binnendeurkozijn (met bovenlicht)
	kruipluik
	opstelplaats wasmachine
	opstelplaats wasdroger
	
	principe opstelling keukenblok

Renvooi installaties

	aansluitpunt licht
	aansluitpunt licht, wand
	centraaldoos met lichtpunt
	armatuur aan de wand
	rookmelder
	aansluitpunt niet bedraad
	verdeelinrichting / meterkast / groepenkast
	beldrukker
	schel
	schakelaar, 1-polig
	werkschakelaar tbv PV-panelen
	schakelaar, 3-polig
	schakelaar, wissel
	schakelaar, kruis
	schakelaar, serie
	wandcontactdoos 1-voudig met beschermingscontact
	wandcontactdoos 2-voudig met beschermingscontact, verticaal
	wandcontactdoos 2-voudig met beschermingscontact
	thermostaatleiding, bedraad
	mechanische ventilatie-unit incl. warmteterugwinunit
	warmtepomp
	inblaasventiel mechanische ventilatie
	afzuigventiel mechanische ventilatie
	verdelers vloerverwarming
	Afleverzet stadswarmte
	ruimte voorzien van vloerverwarming
	elektrische radiator
	kanalen in het zicht

Disclaimer

De op deze tekeningen aangegeven maten zijn circa maten in millimeters en tussen de wanden / vloeren gemeten, waarbij geen rekening is gehouden met enige wandafwerking, plinten, aftimmering, ect. In verband met de nauwkeurige uitwerking van details, constructie, maatvoering, materialen e.d. kunnen er kleine afwijkingen ontstaan ten opzichte van de nu vermelde gegevens. Deze geringe afwijkingen geven geen aanleiding tot verrekening. Aan de op deze tekening aangegeven maten kunnen derhalve geen rechten worden ontleend. De op deze tekeningen aangegeven maatvoering is niet geschikt voor opdrachten aan derden door koper(s). De posities van aansluitingen en installatie onderdelen zijn indicatief op tekening aangegeven. De exacte aantallen en posities zullen na berekening in het werk door de installateurs worden bepaald en kunnen afwijken van deze tekening.

**ALLEMAAL
YIELEYAAL**

Tekening: Renvooi

Woningtype: -

Bouwnummer: -

Bladnummer: VT-0-00c

Schaal: -

Datum: 30-01-2024



Type: WU
bwnr: 302

Type: W
bwnr: 303

Type: W
bwnr: 304

Type: WU
bwnr: 305

Voorgevel

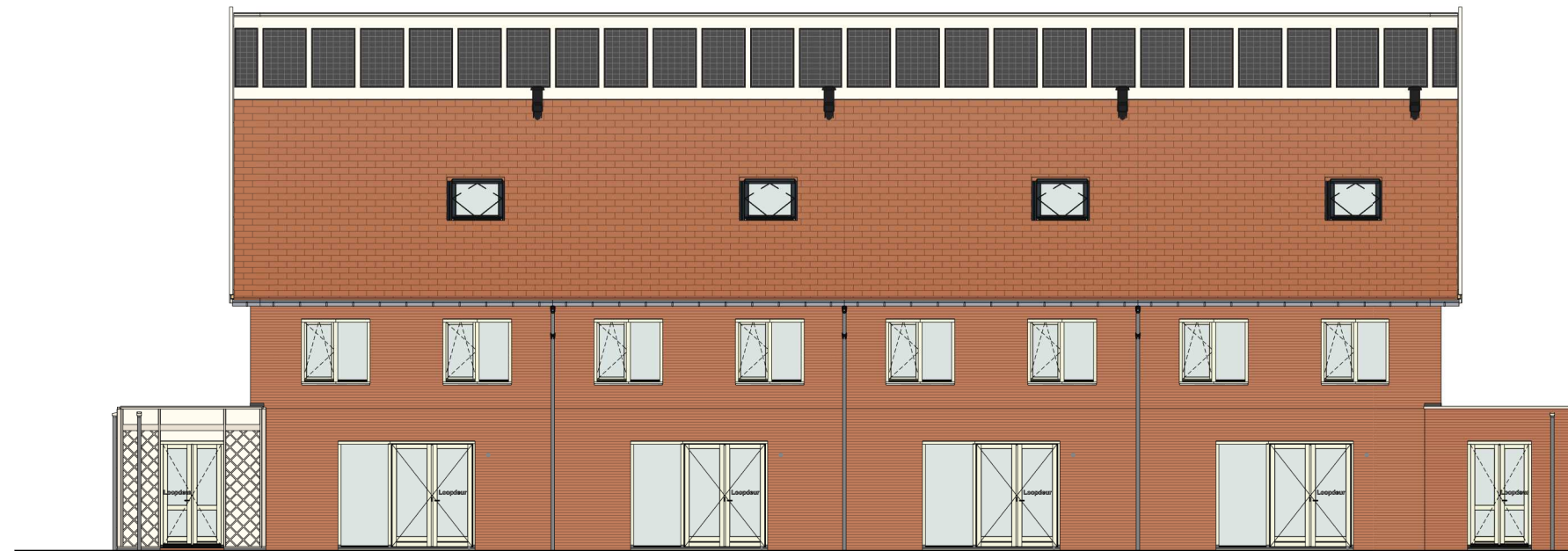

Type: WU
bwnr: 305

Type: W
bwnr: 304

Type: W
bwnr: 303

Type: WU
bwnr: 302

Achtergevel

ALLEMAAL
YIELEYAAL

Tekening: Gevels blok L5

Woningtype: W, WU

Bouwnummer: 302 t/m 305

Bladnummer: VT-L5-00a

Schaal: 1:150

Datum: 30-01-2024

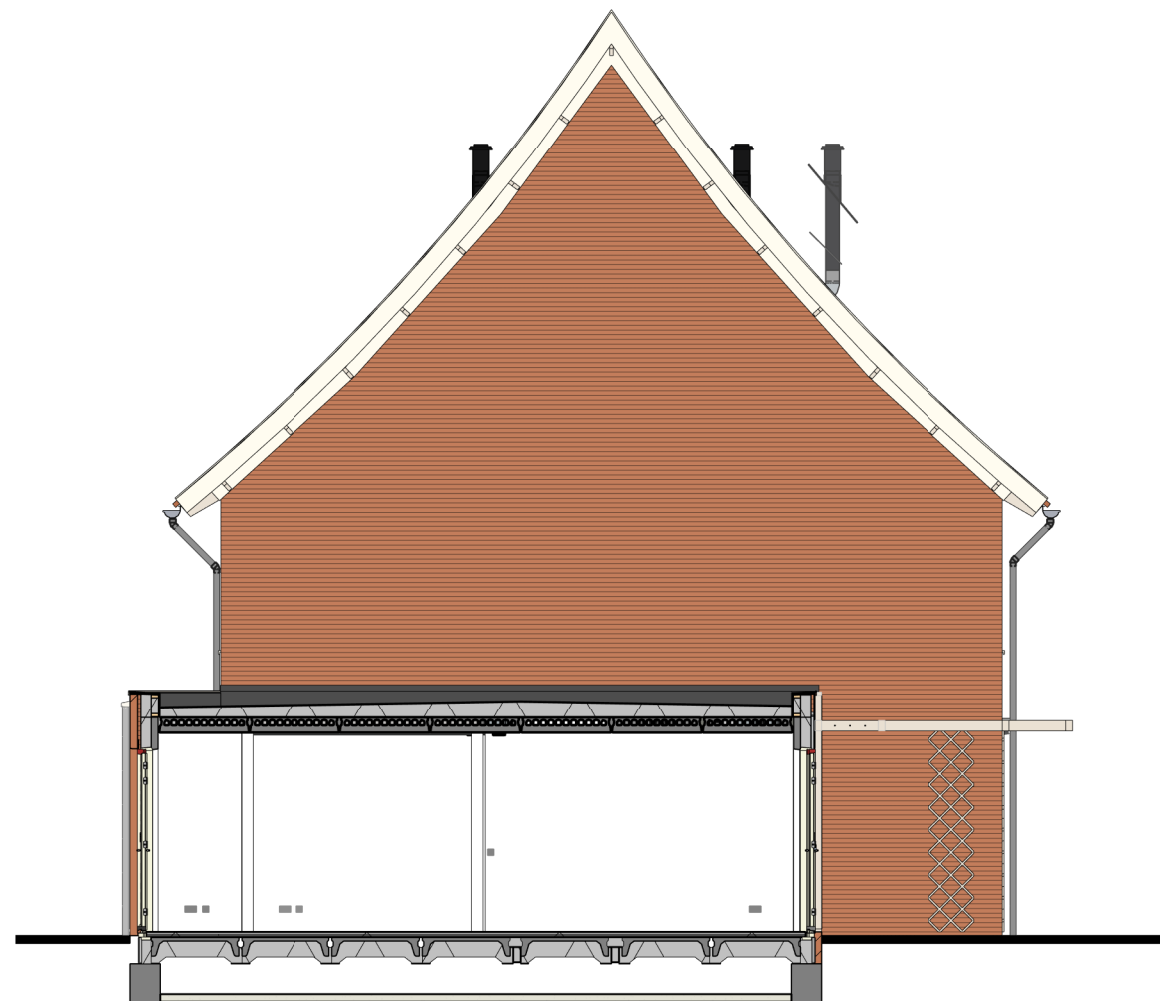

Type: WU
Bouwnummer: 302

Linker zijgevel



Type: WU
Bouwnummer: 305

Rechter zijgevel

ALLEMAAL
YIELEYAAL

Tekening: Zijgevels blok L5

Woningtype: W, WU

Bouwnummer: 302 t/m 305

Bladnummer: VT-L5-00b

Schaal: 1:100

Datum: 30-01-2024

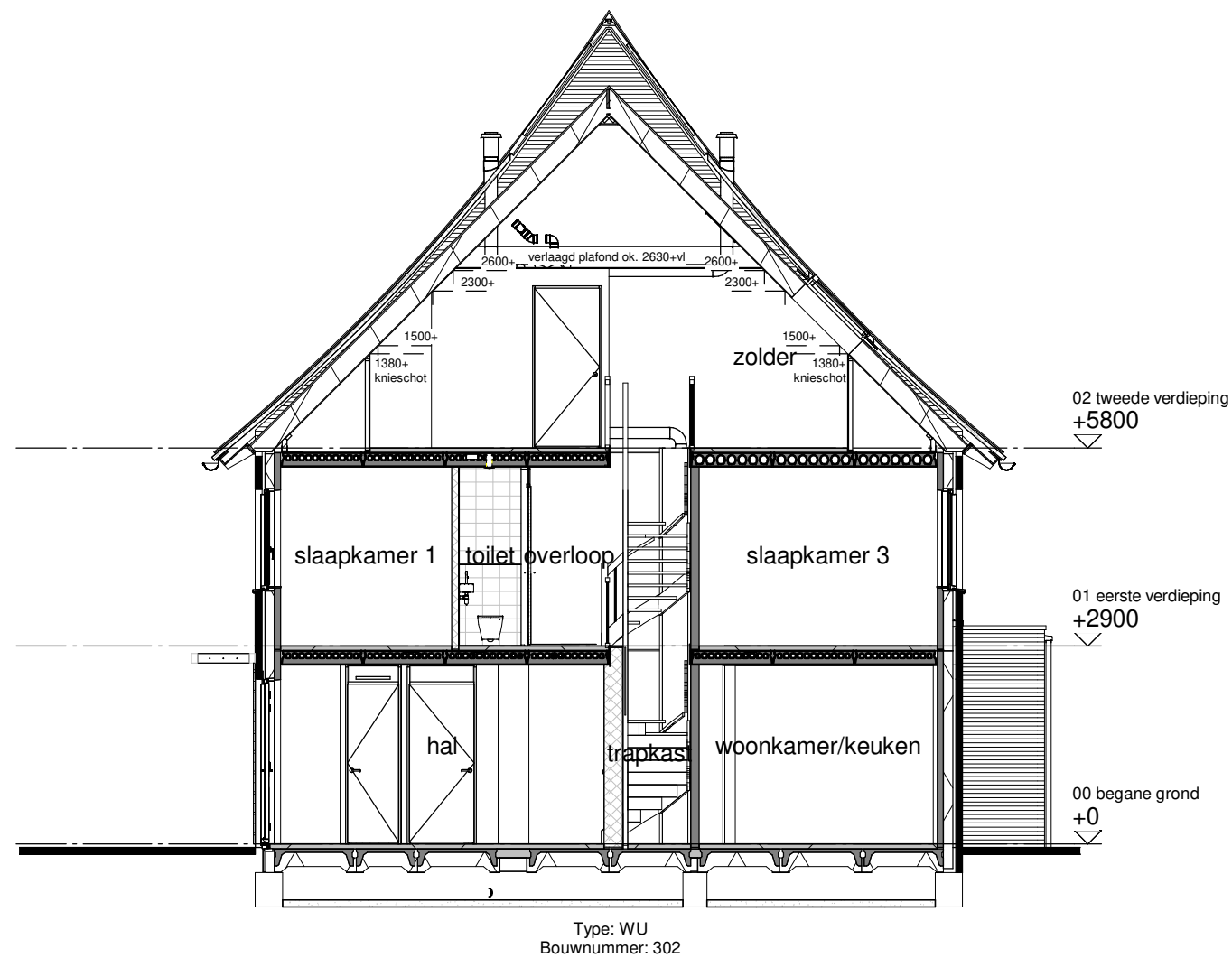

Doorsnede A

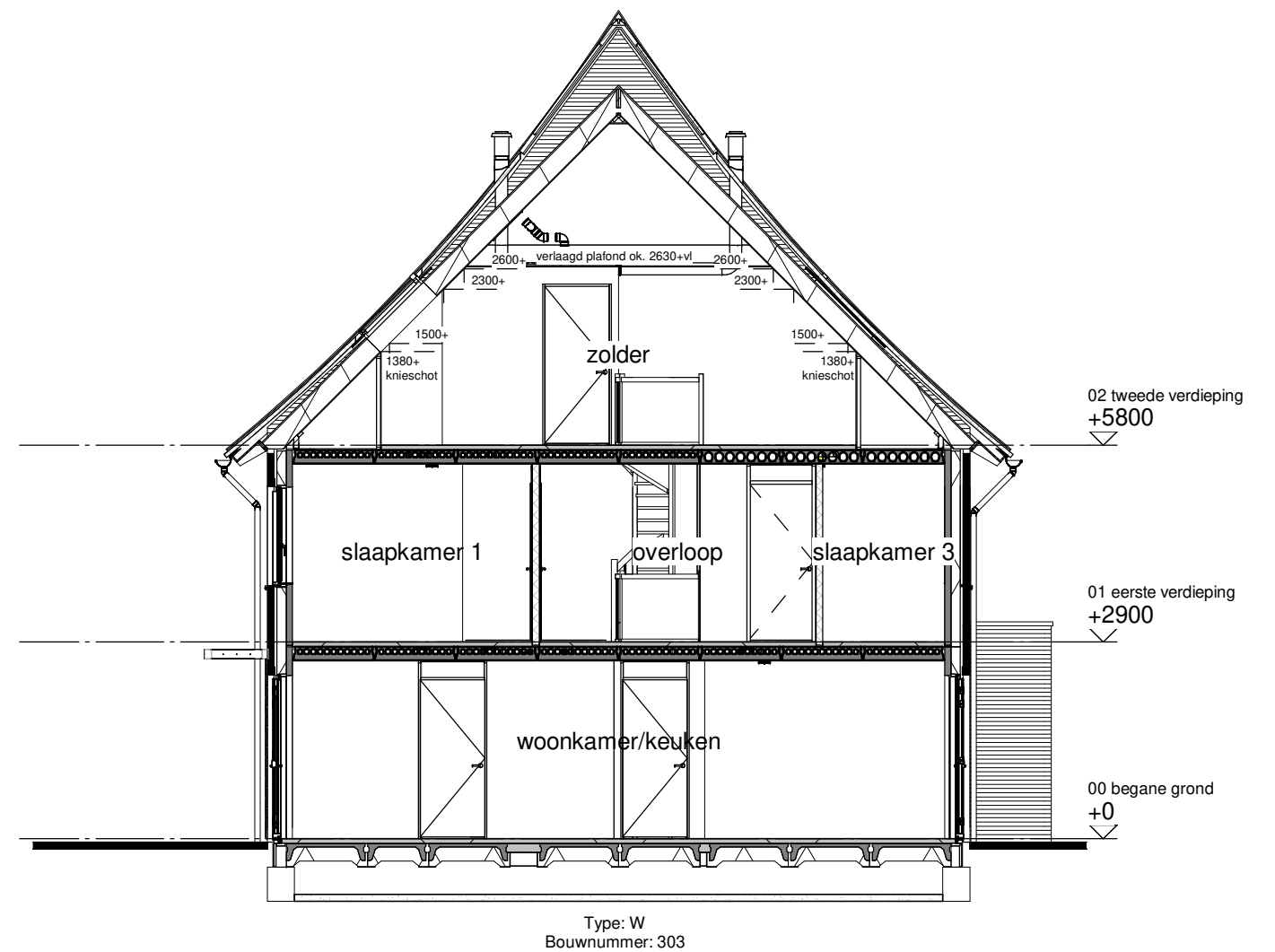

Doorsnede B

**ALLEMAAL
YIELEYAAL**

Tekening: Doorsnedes blok L5

Woningtype: W, WU

Bouwnummer: 302 t/m 305

Bladnummer: VT-L5-00c

Schaal: 1:100

Datum: 30-01-2024

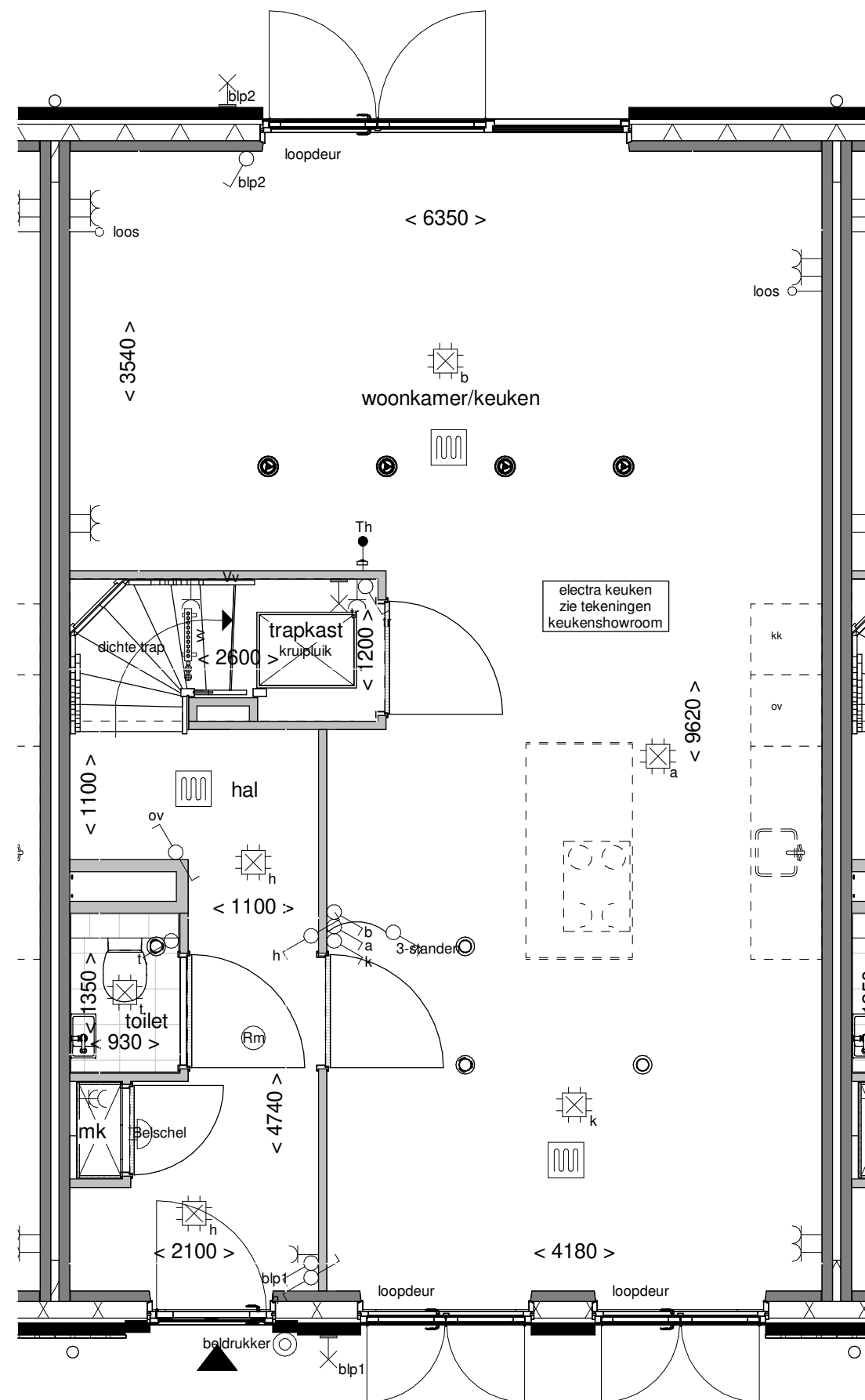

**ALLEMAAL
VIELEVAAL**

Tekening: Begane grond
 Woningtype: W
 Bouwnummer: 303
 Bladnummer: VT-L5-303a
 Schaal: 1:50
 Datum: 30-01-2024

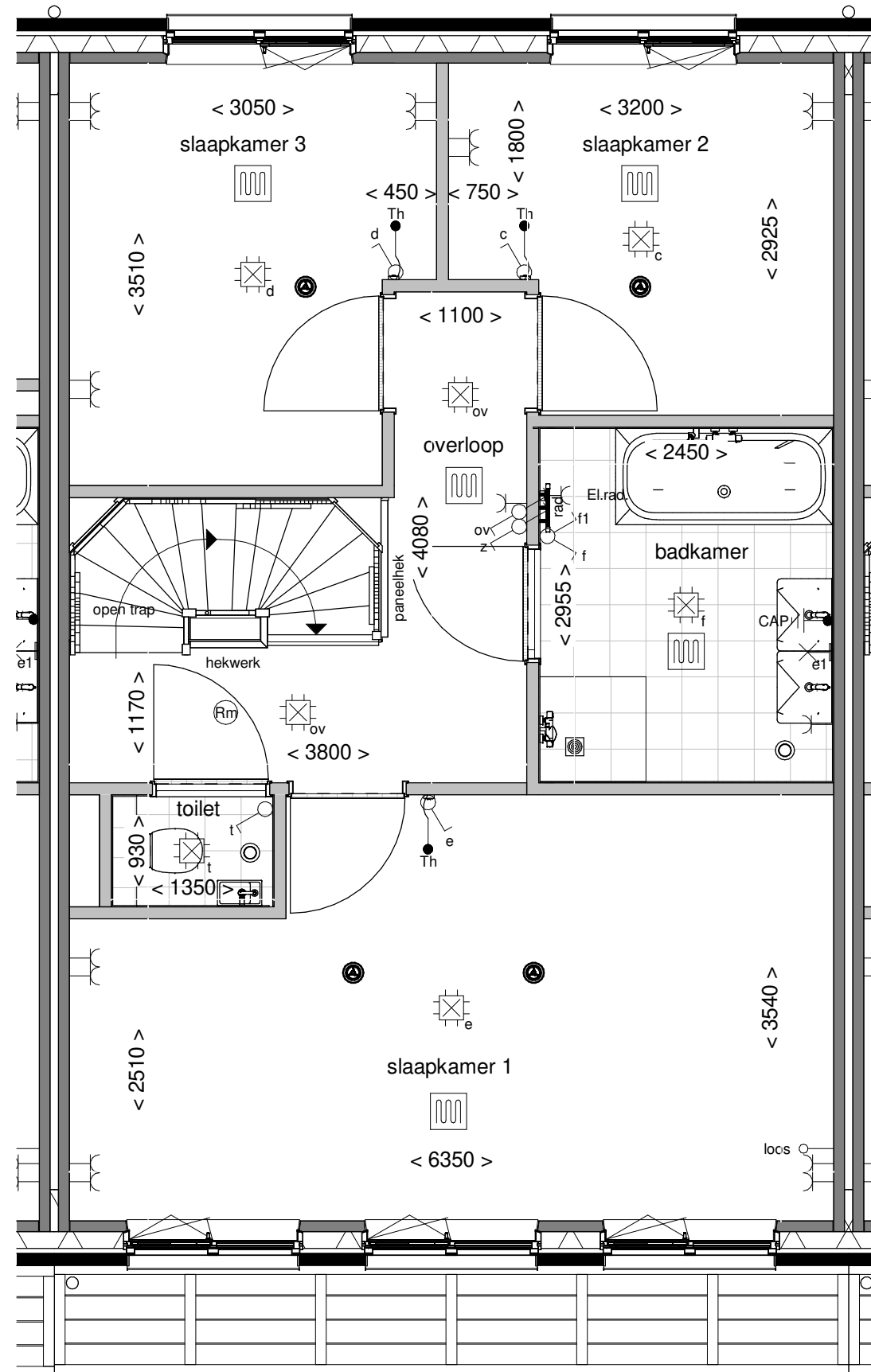

**ALLEMAAL
VIELEJAAL**

Tekening: Eerste verdieping
 Woningtype: W
 Bouwnummer: 303
 Bladnummer: VT-L5-303b
 Schaal: 1:50
 Datum: 30-01-2024

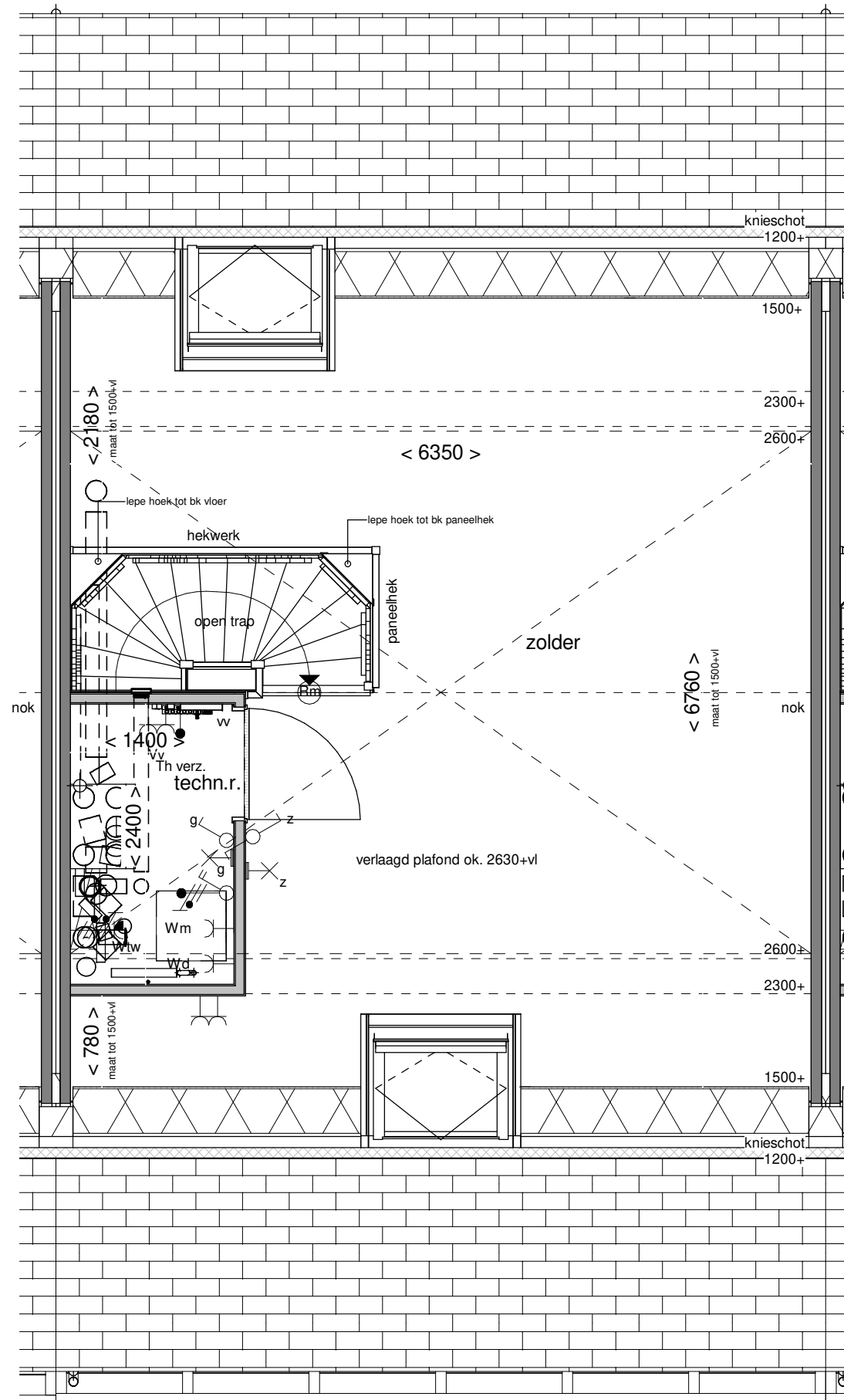

**ALLEMAAL
YIELEYAAL**

Tekening: Tweede verdieping
 Woningtype: W
 Bouwnummer: 303
 Bladnummer: VT-L5-303c
 Schaal: 1:50
 Datum: 30-01-2024

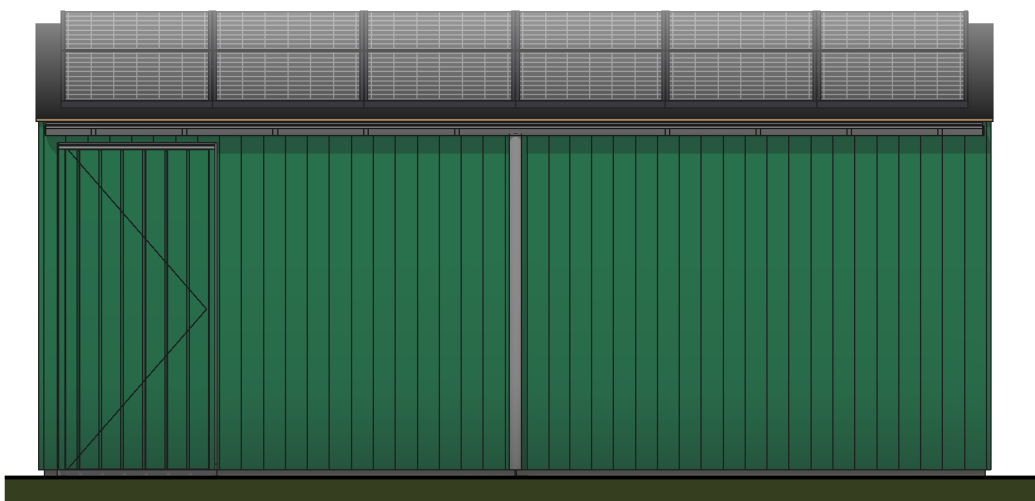

Voorgevel

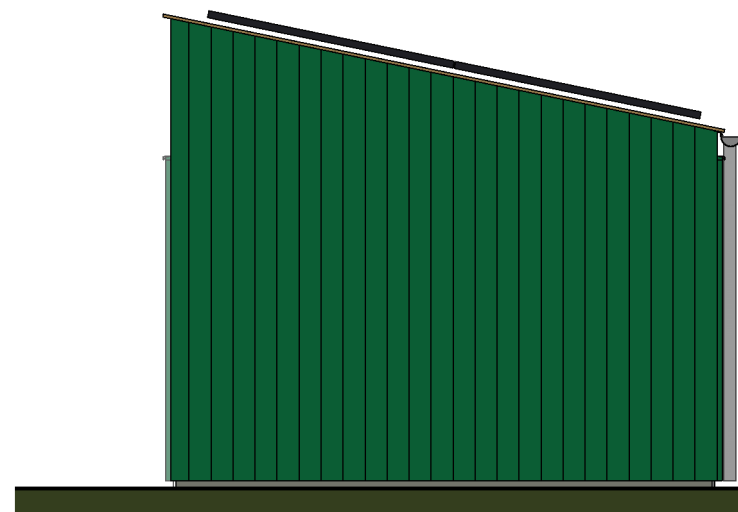

Linker zijgevel

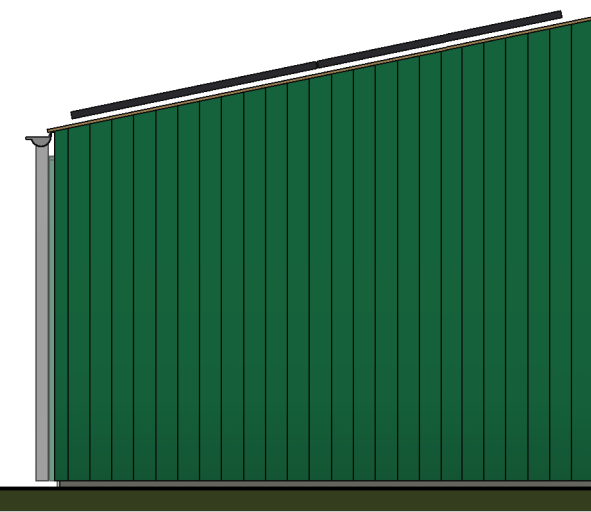

Rechter zijgevel

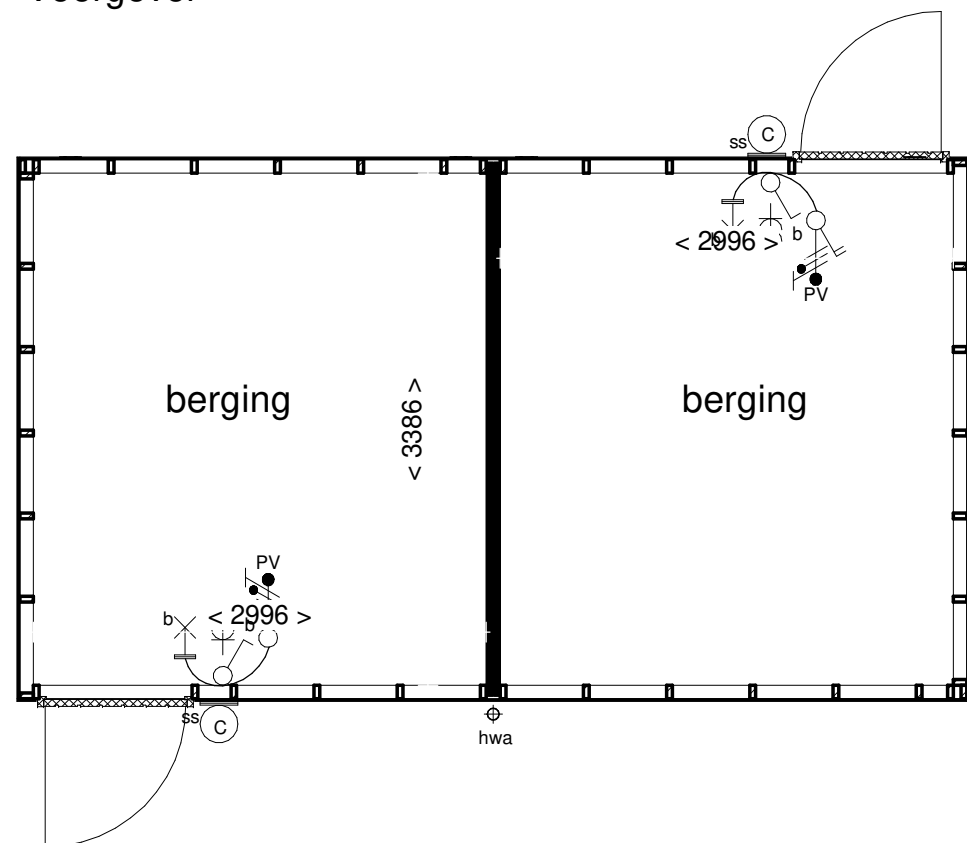

Begane grond

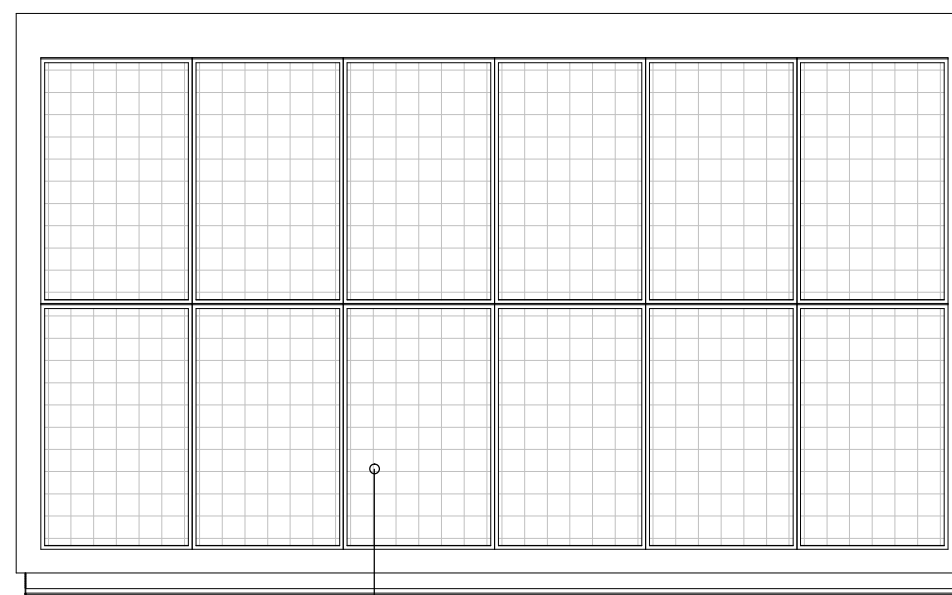

maximaal aantal pv-panelen weergegeven
aantal kan verschillen per woning/berging

Dakaanzicht

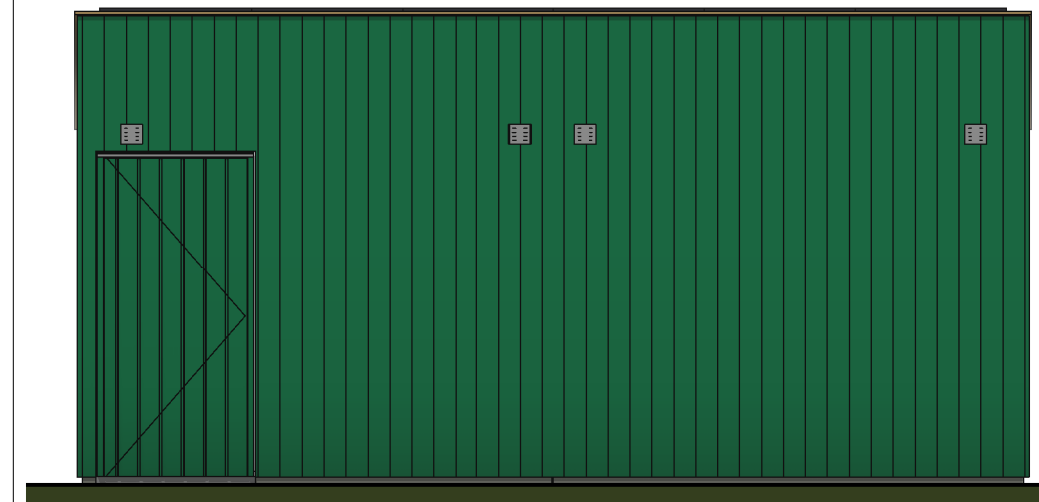

Achtergevel

Als getekend:
bnr. 300 - 301
bnr. 302 - 303
bnr. 304 - 305

Gespiegeld:
bnr. 231 - 232
bnr. 233 - 234
bnr. 244 - 245

bnr. 246 - 247
bnr. 248 - 249

**ALLEMAAL
YIELEYAAL**

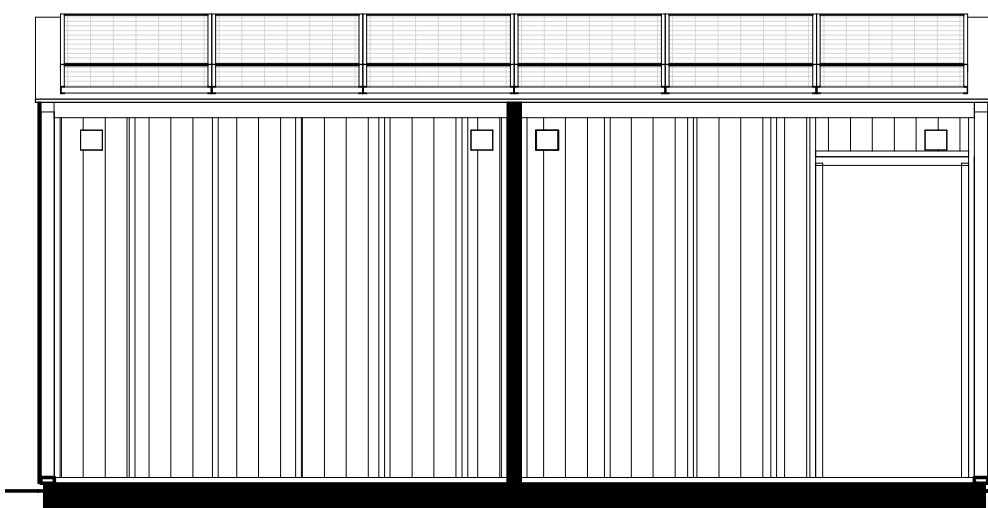

Doorsnede A-A

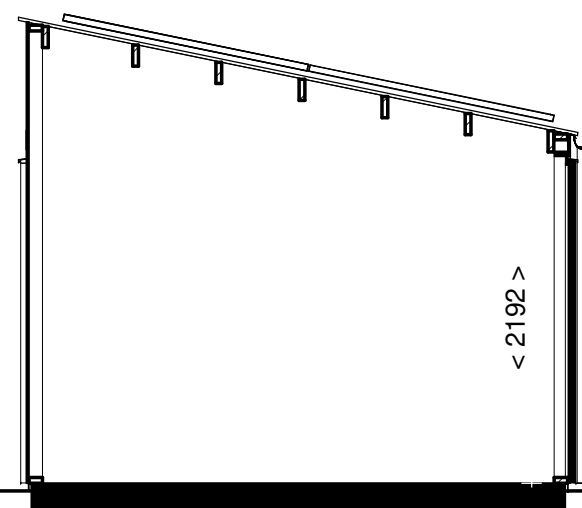

Doorsnede B-B



3D aanzicht

Tekening: **Berging B**

Woningtype: -

Bouwnummer:

Bladnummer: **VT-BE02**

Schaal: **1:50**

Datum: **30-01-2024**

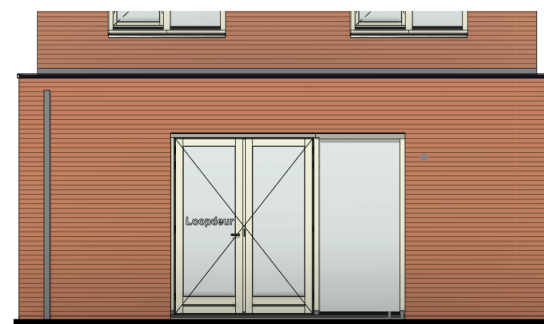
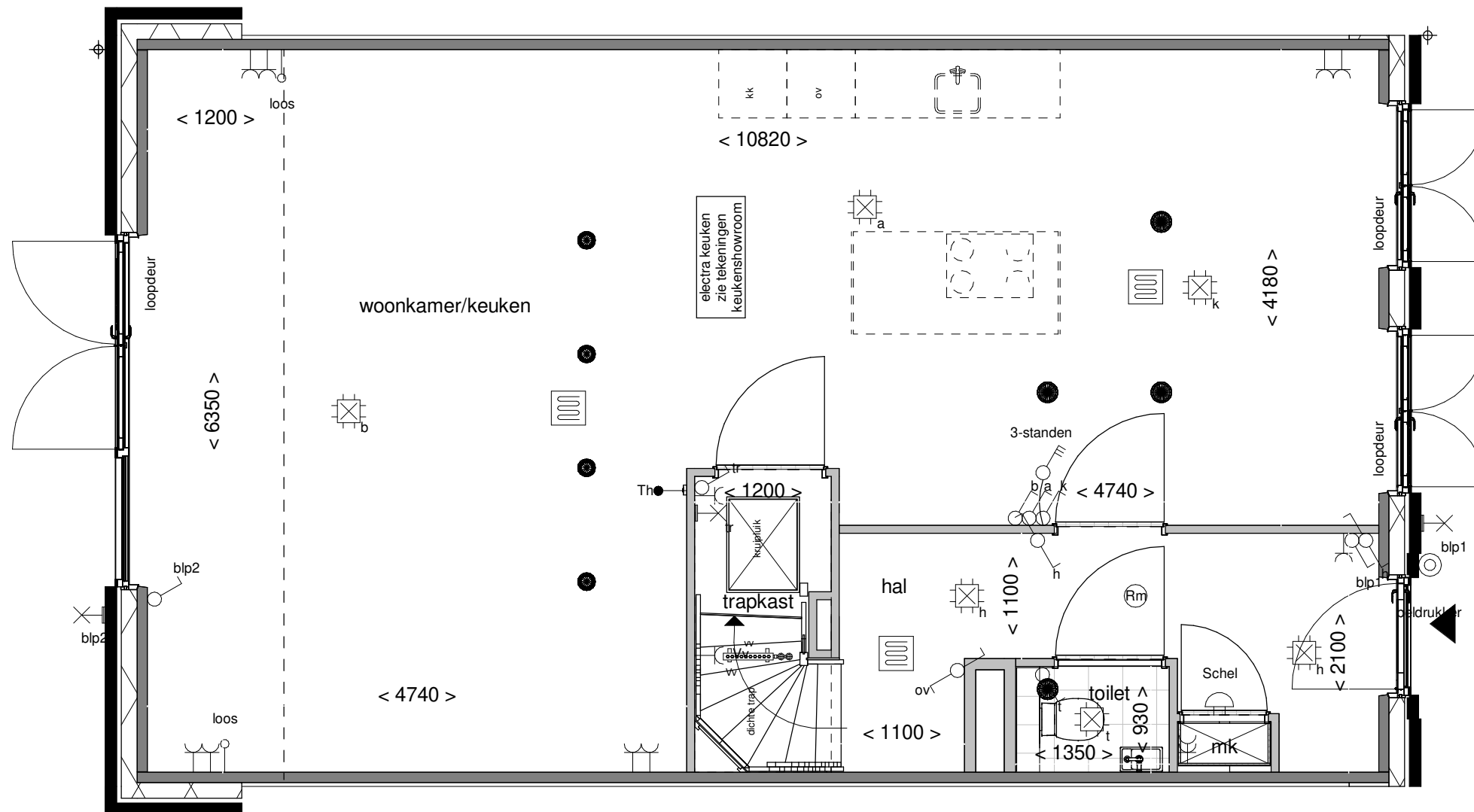

Achtergevel schaal 1:100

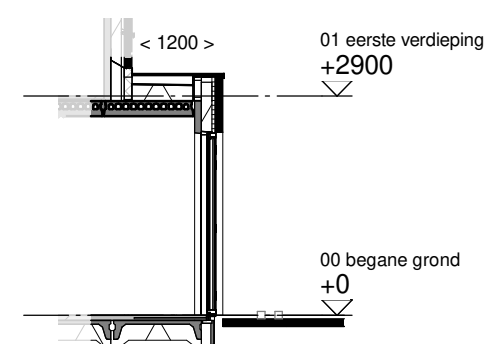

Doorsnede schaal 1:100

**ALLEMAAL
YIELEYAAL**

Optie: **Uitbouw achtergevel
1200mm**

Woningtype: **W66**

Bouwnummer: -

Optienummer: **0.A.W.12**

Schaal: **1:50 / 1:100**

Datum: **30-01-2024**

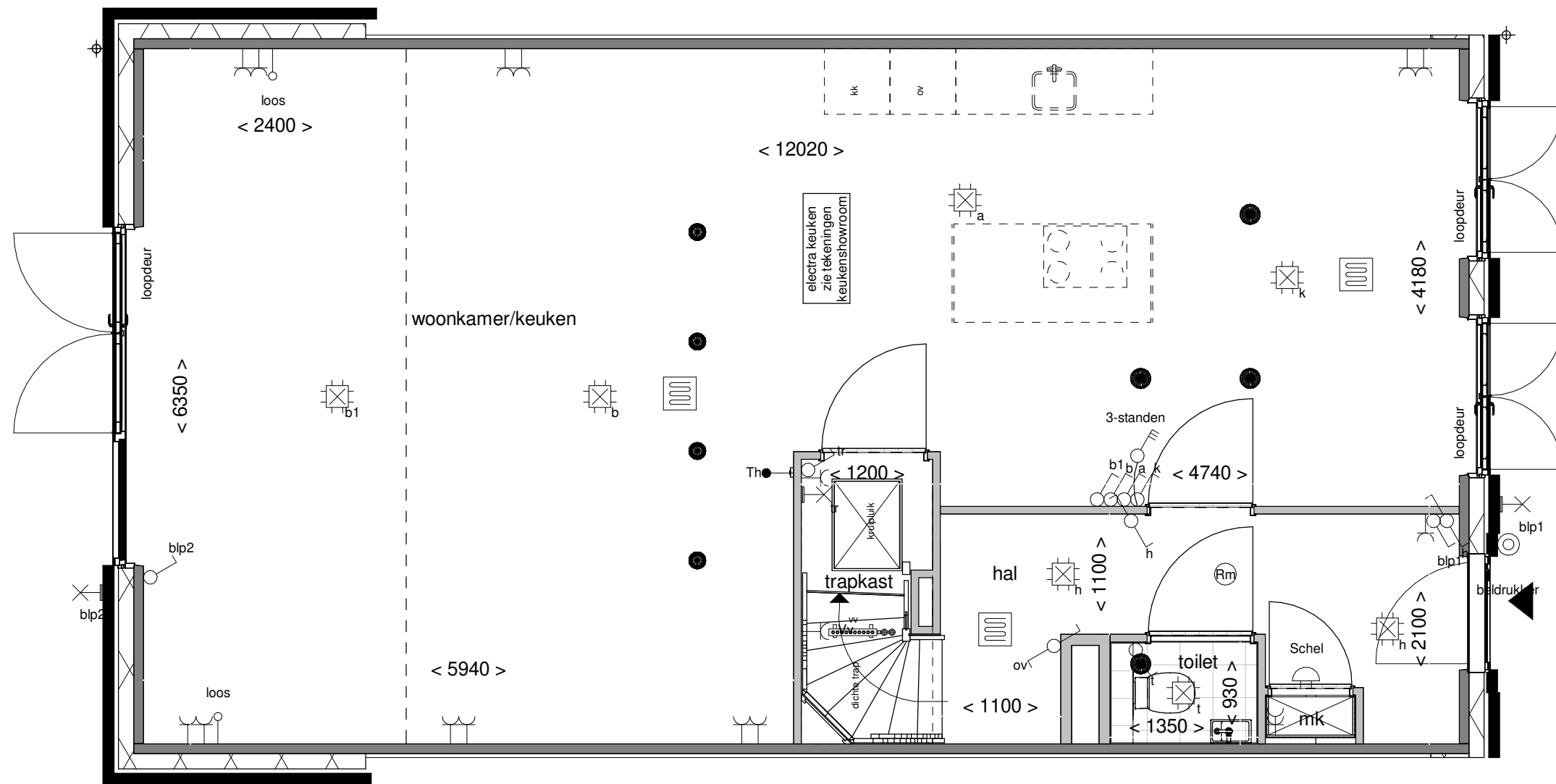

Achtergevel schaal 1:100

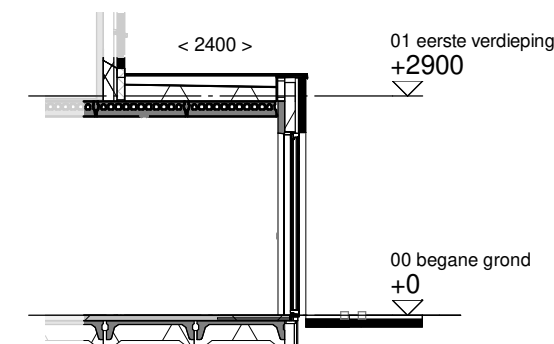

Doorsnede schaal 1:100

ALLEMAAL
YIELEYAAL

Optie: **Uitbouw achtergevel
2400mm**

Woningtype: **W66**

Bouwnummer: -

Optienummer: **0.A.W.32**

Schaal: **1:50 / 1:100**

Datum: **30-01-2024**

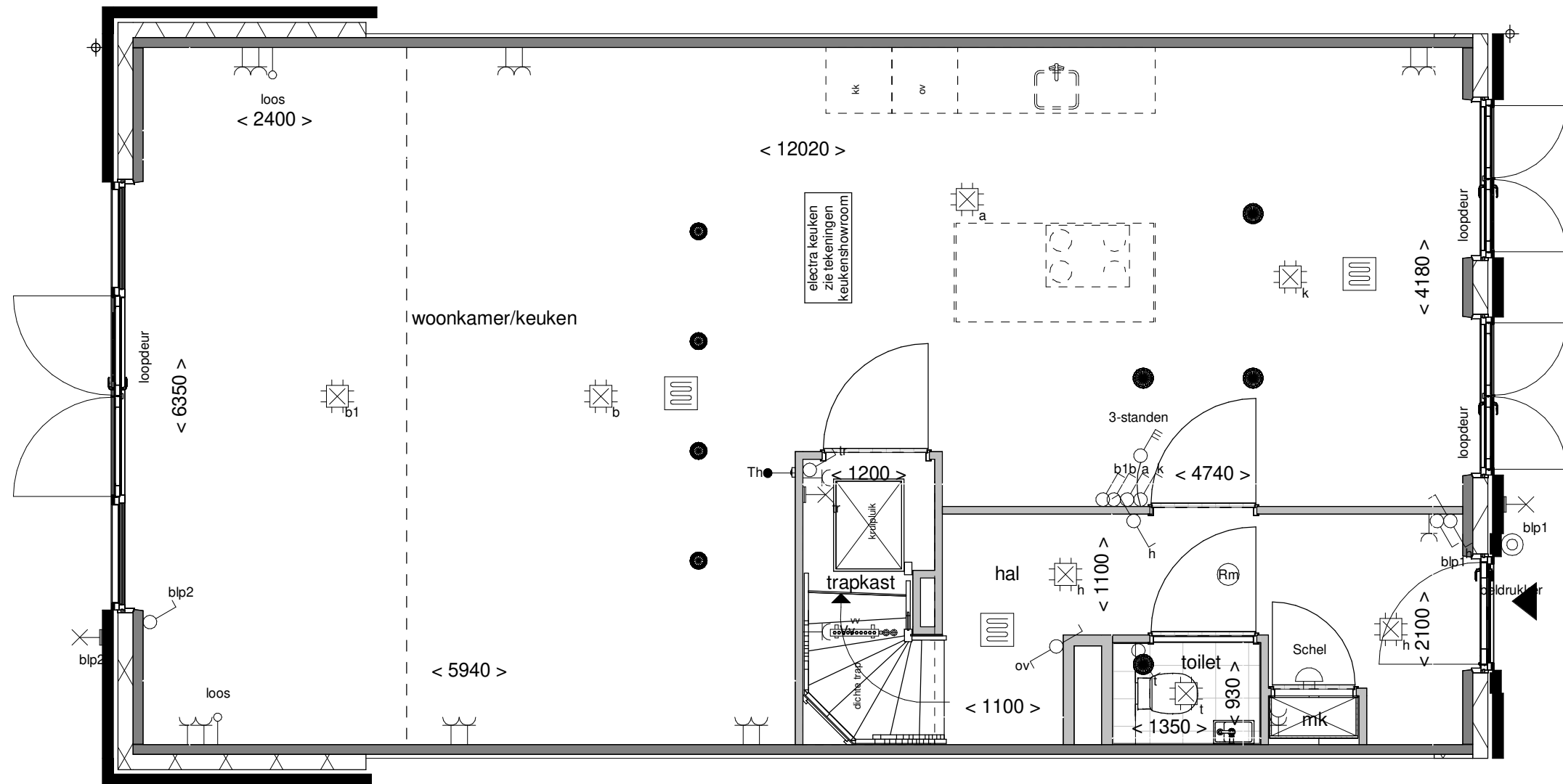

Achtergevel schaal 1:100

**ALLEMAAL
VIELEYAAL**

Optie: Dubbele deuren
achtergevel 3900mm

Woningtype: W66

Bouwnummer: -

Optienummer: 1.A.X.62

Schaal: 1:50 / 1:100

Datum: 30-01-2024

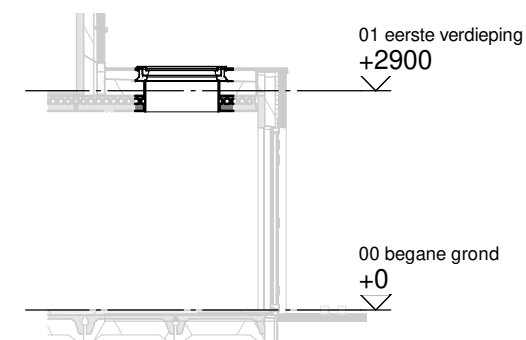
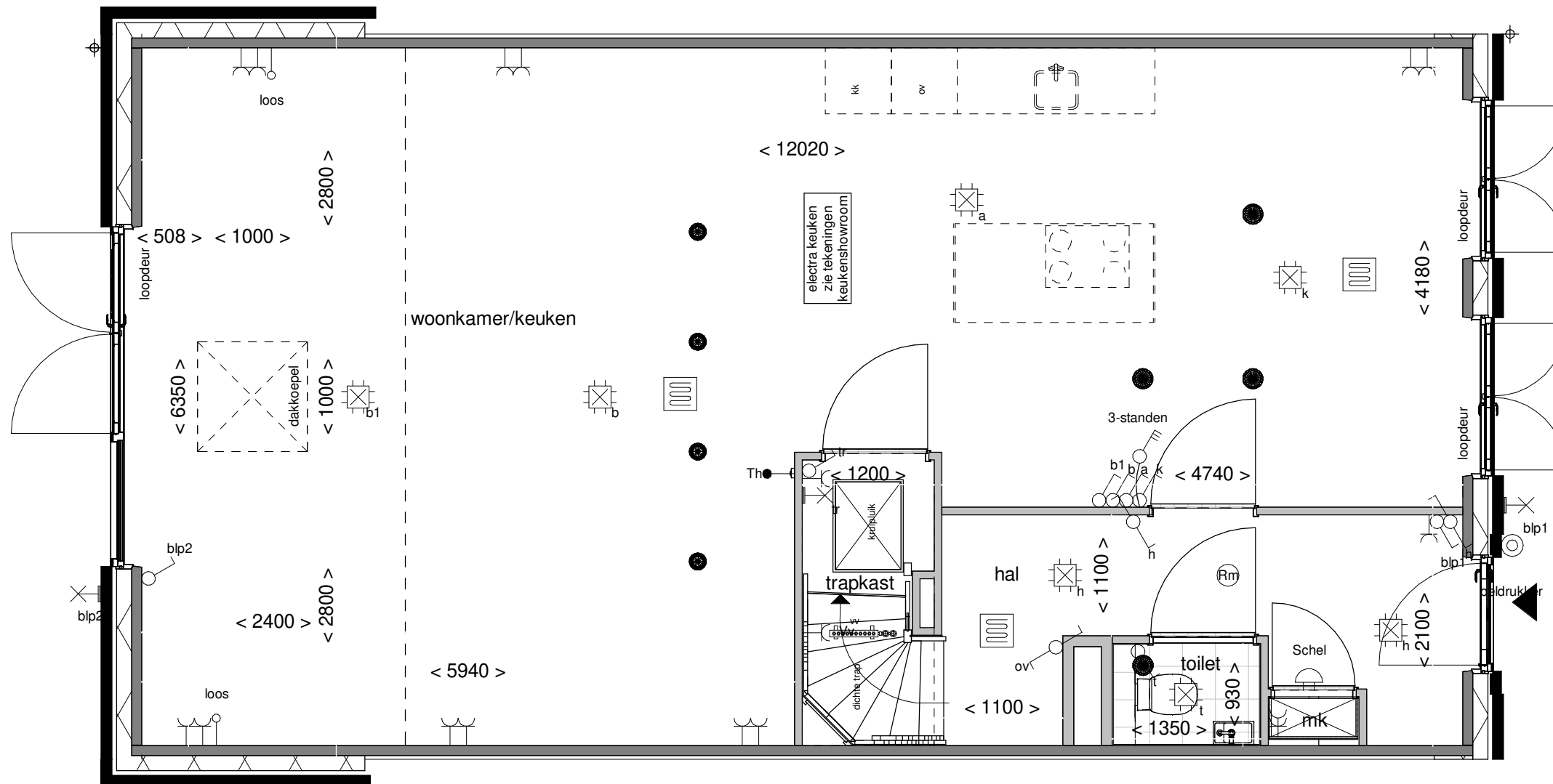

Doorsnede schaal 1:100

**ALLEMAAL
YIELEYAAL**

Optie: Lichtkoepel in uitbouw 2400mm

Woningtype: W66

Bouwnummer: -

Optienummer: 1.B.X.10

Schaal: 1:50 / 1:100

Datum: 30-01-2024

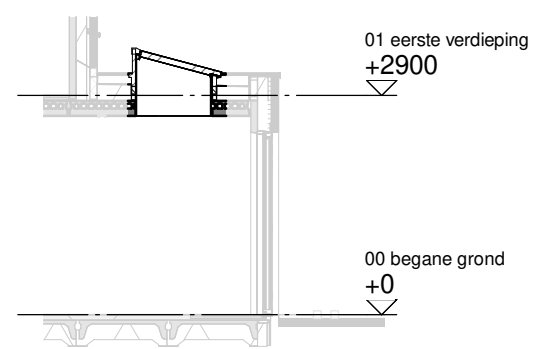
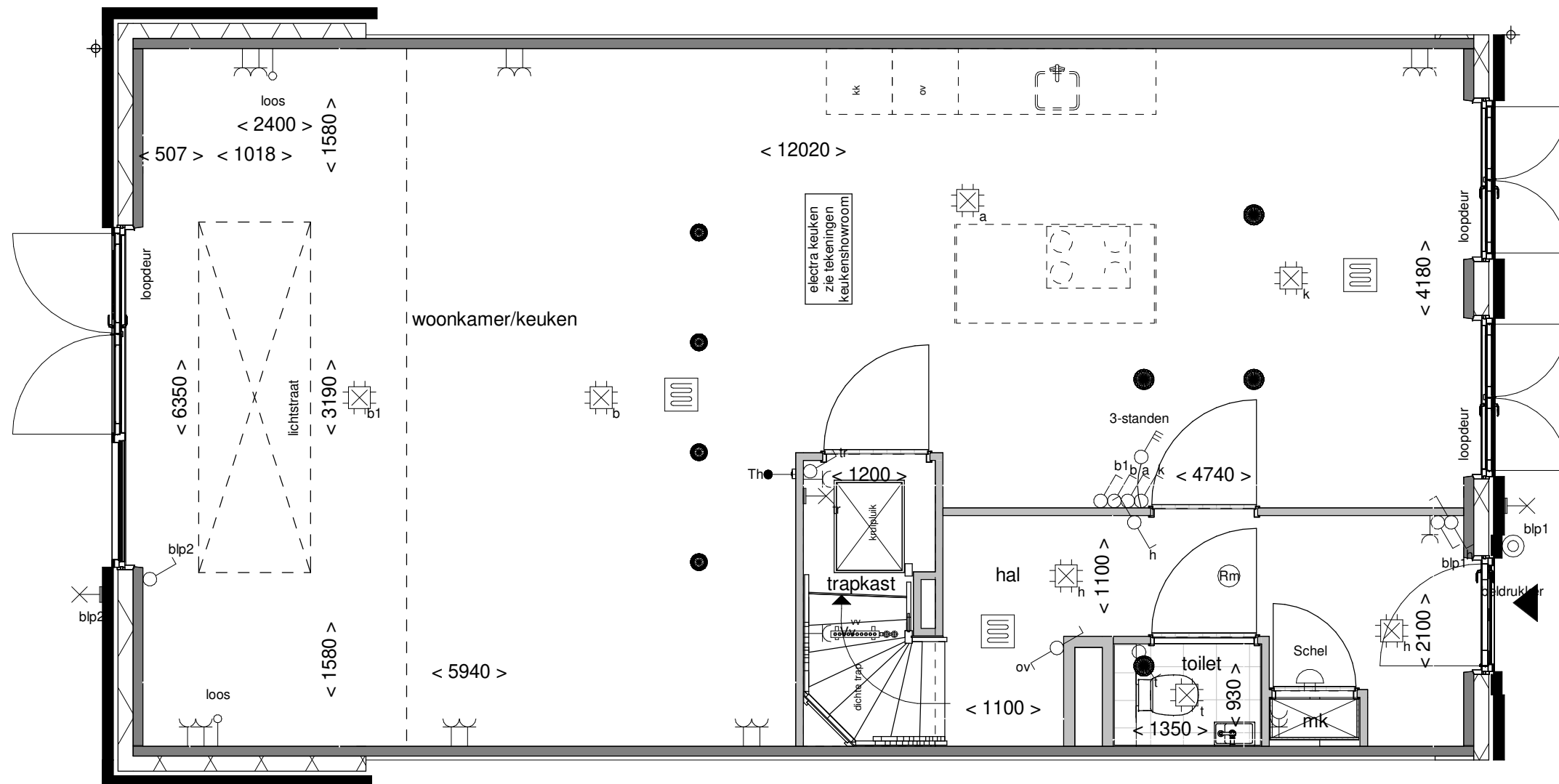

Doorsnede schaal 1:100

**ALLEMAAL
VIELEYAAL**

Optie: Lichtstraat in uitbouw
2400mm

Woningtype: W66

Bouwnummer: -

Optienummer: 1.B.X.14

Schaal: 1:50 / 1:100

Datum: 30-01-2024

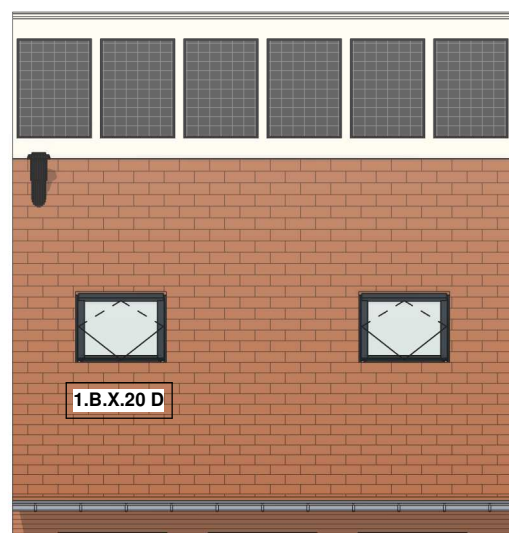
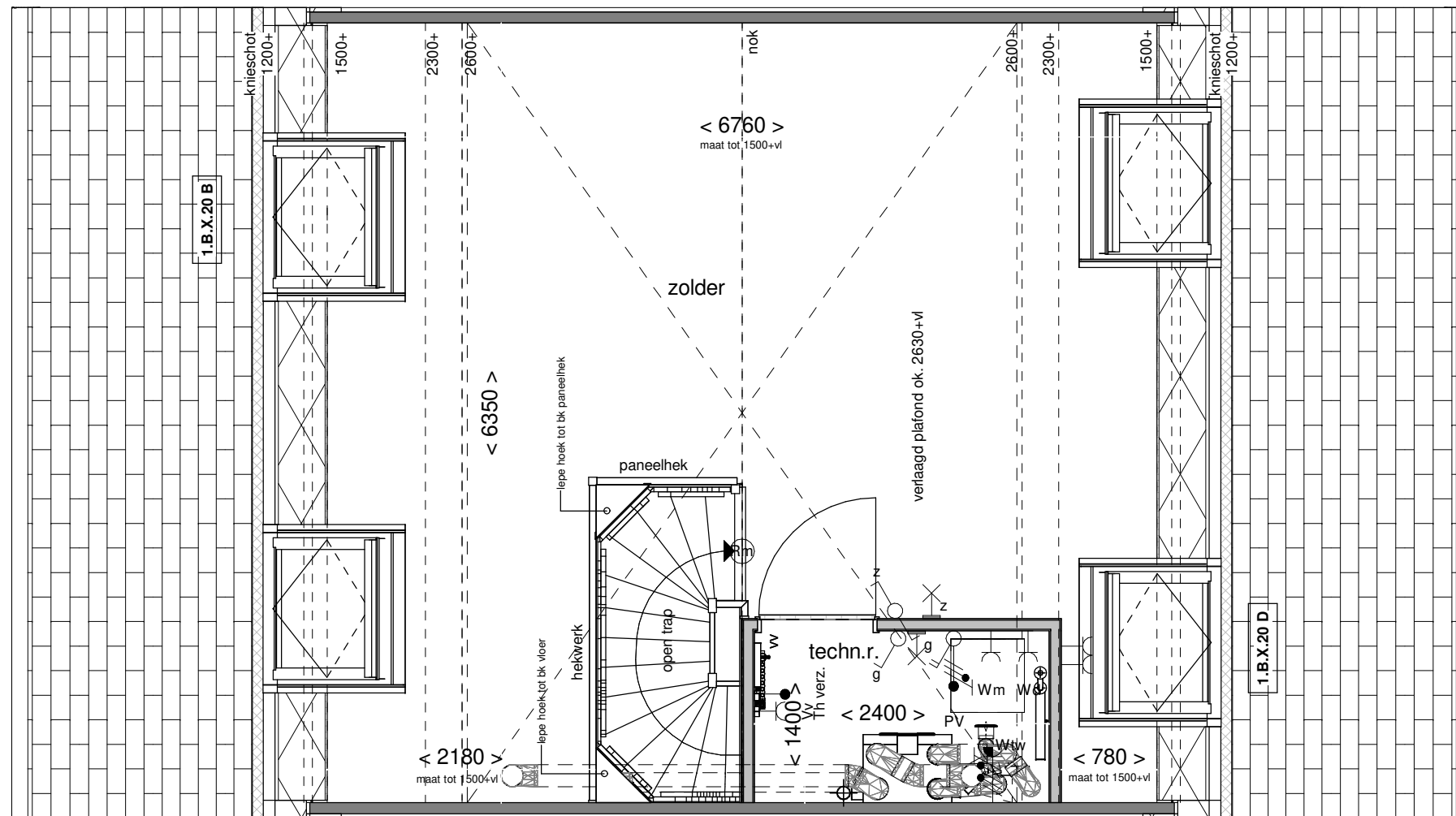

Voorgevel schaal 1:100

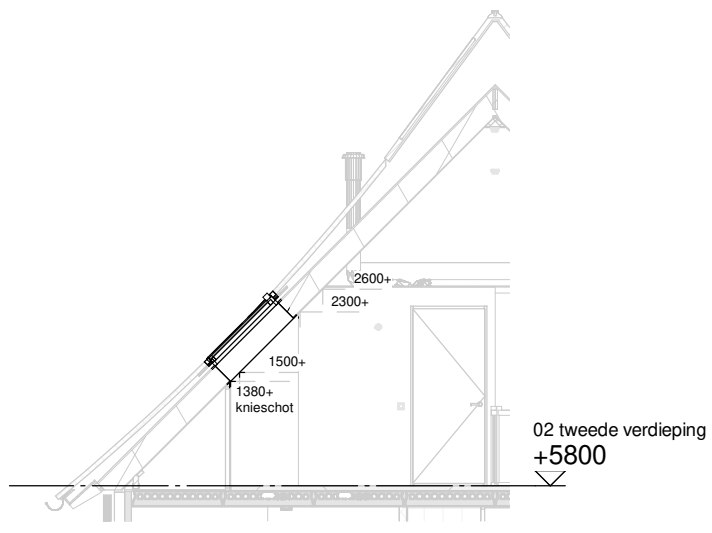

Doorsnede schaal 1:100

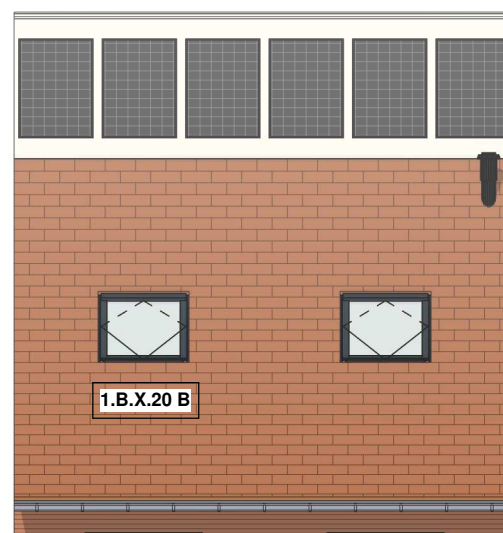

Achtergevel schaal 1:100

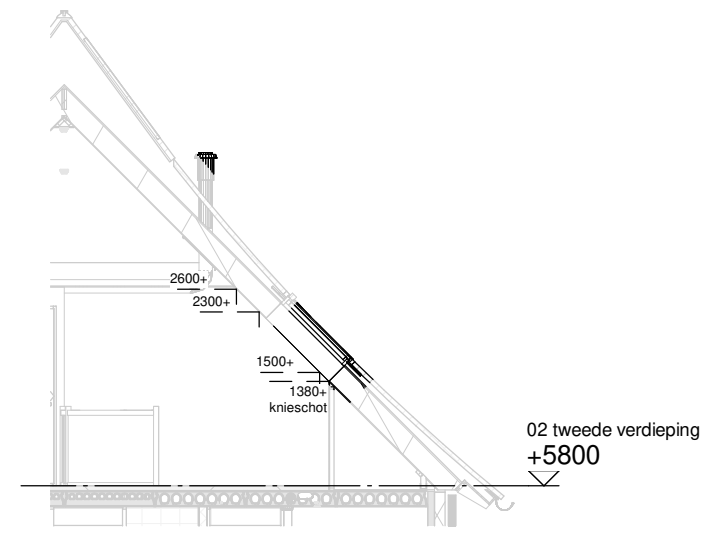

Doorsnede schaal 1:100

**ALLEMAAL
YIELEYAAL**

Optie: Dakramen voor- en achtergevel

Woningtype: W66

Bouwnummer: -

Optienummer: 1.B.X.20

Schaal: 1:50 / 1:100

Datum: 30-01-2024

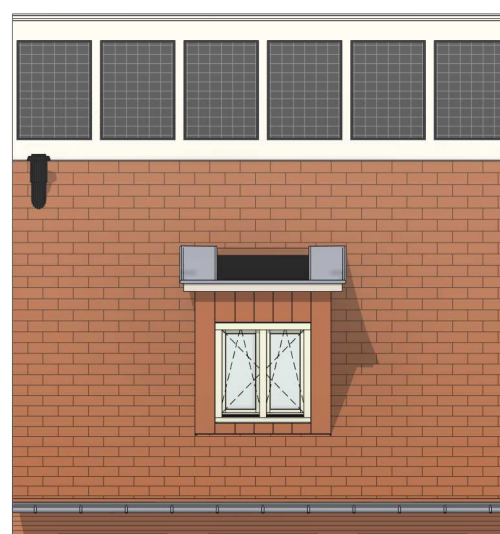
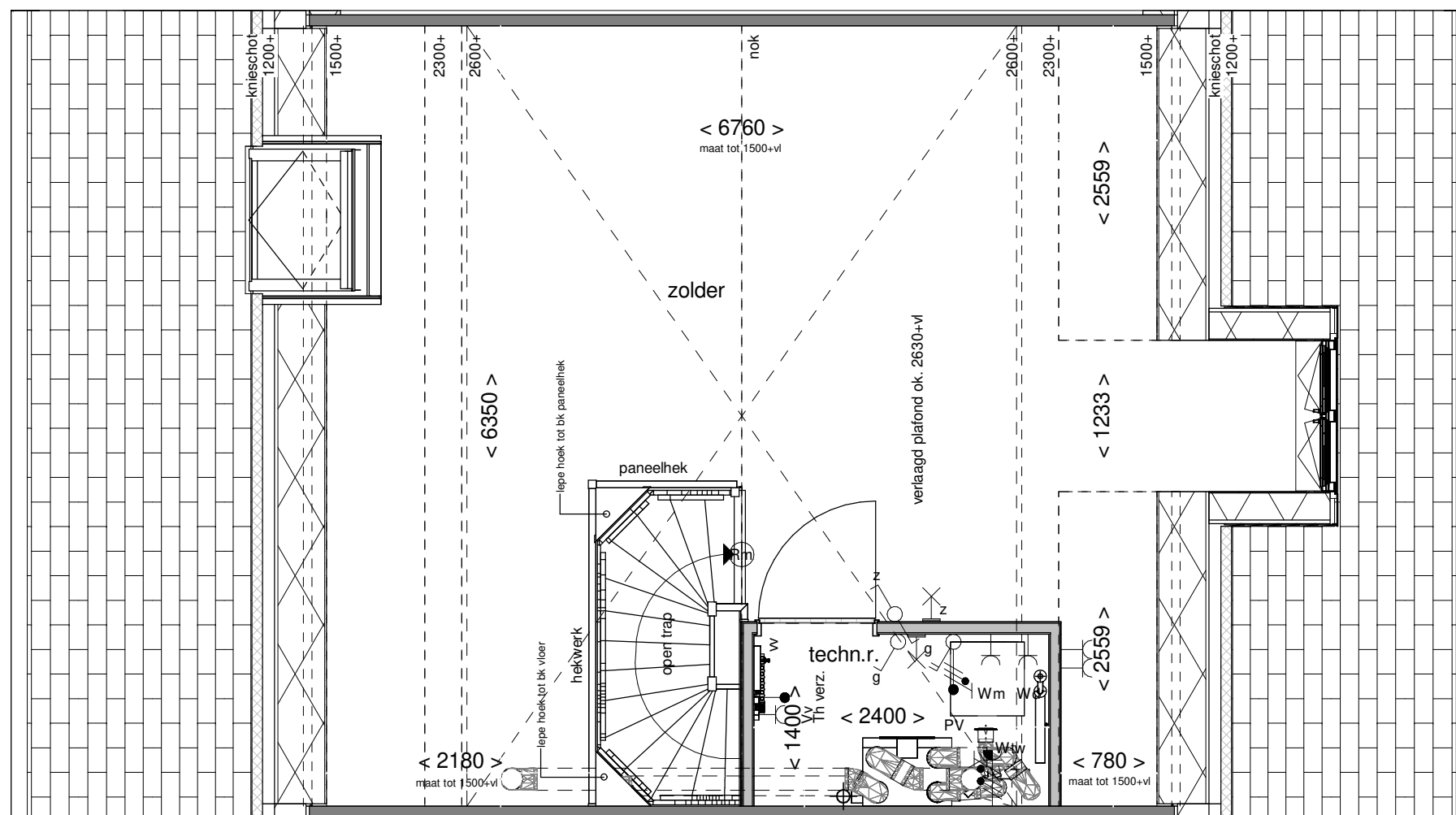

Voorgevel schaal 1:100

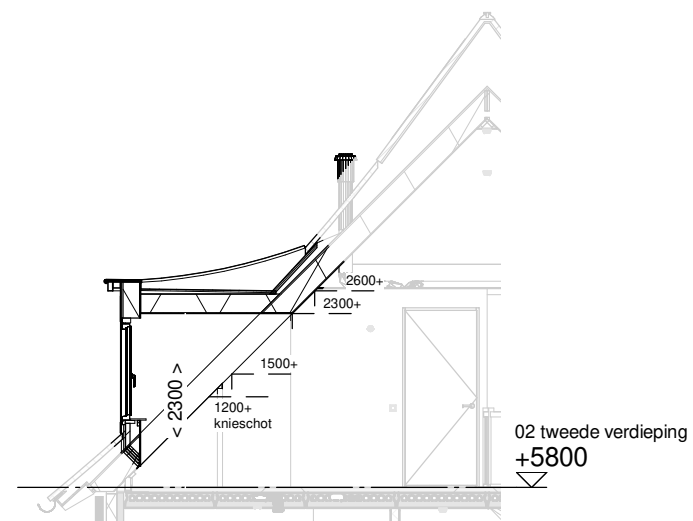

Doorsnede schaal 1:100

**ALLEMAAL
YIELEYAAL**

Optie: Dakkapel
voorgevel 1500mm

Woningtype: W66

Bouwnummer: -

Optienummer: 1.B.X.33

Schaal: 1:50 / 1:100

Datum: 30-01-2024

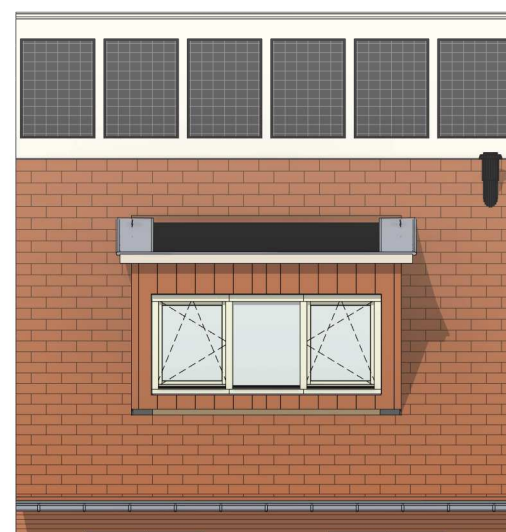
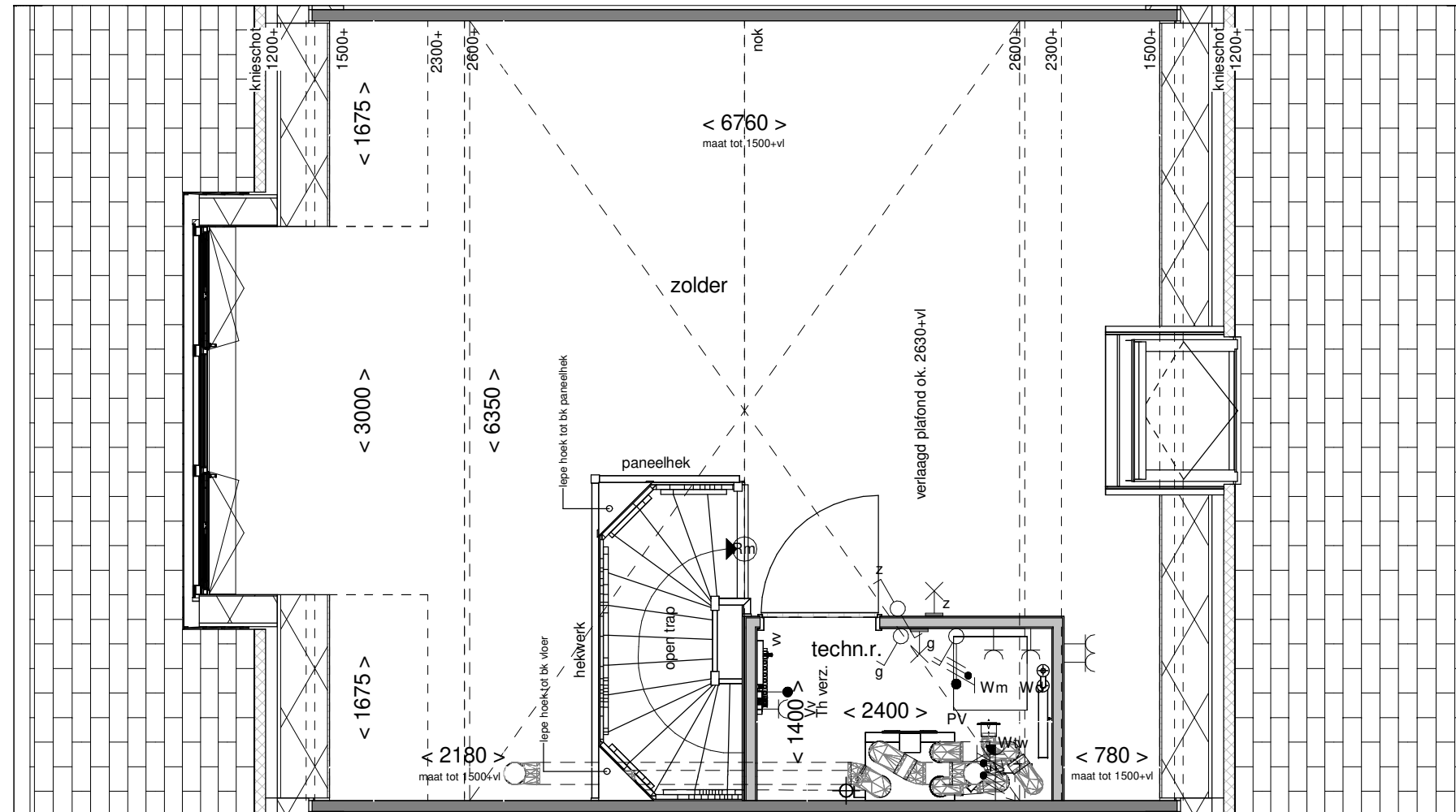

Achtergevel schaal 1:100

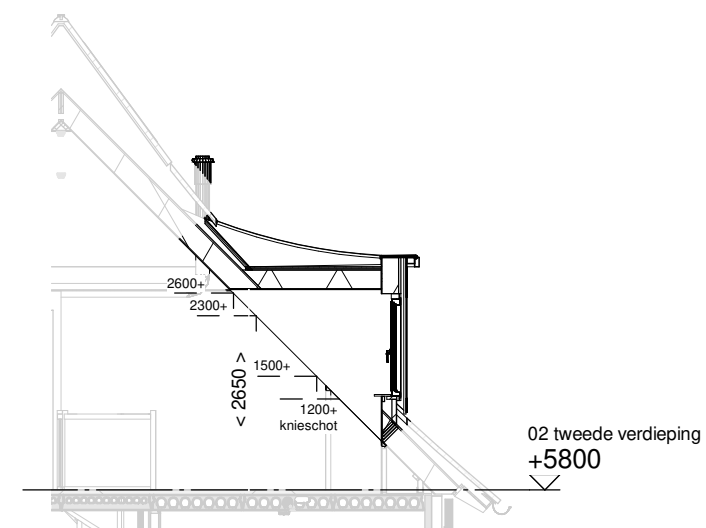

Doorsnede schaal 1:100

**ALLEMAAL
VIELEYAAL**

Optie: Dakkapel
achtergevel 3000mm

Woningtype: W66

Bouwnummer: -

Optienummer: 1.B.X.34

Schaal: 1:50 / 1:100

Datum: 30-01-2024

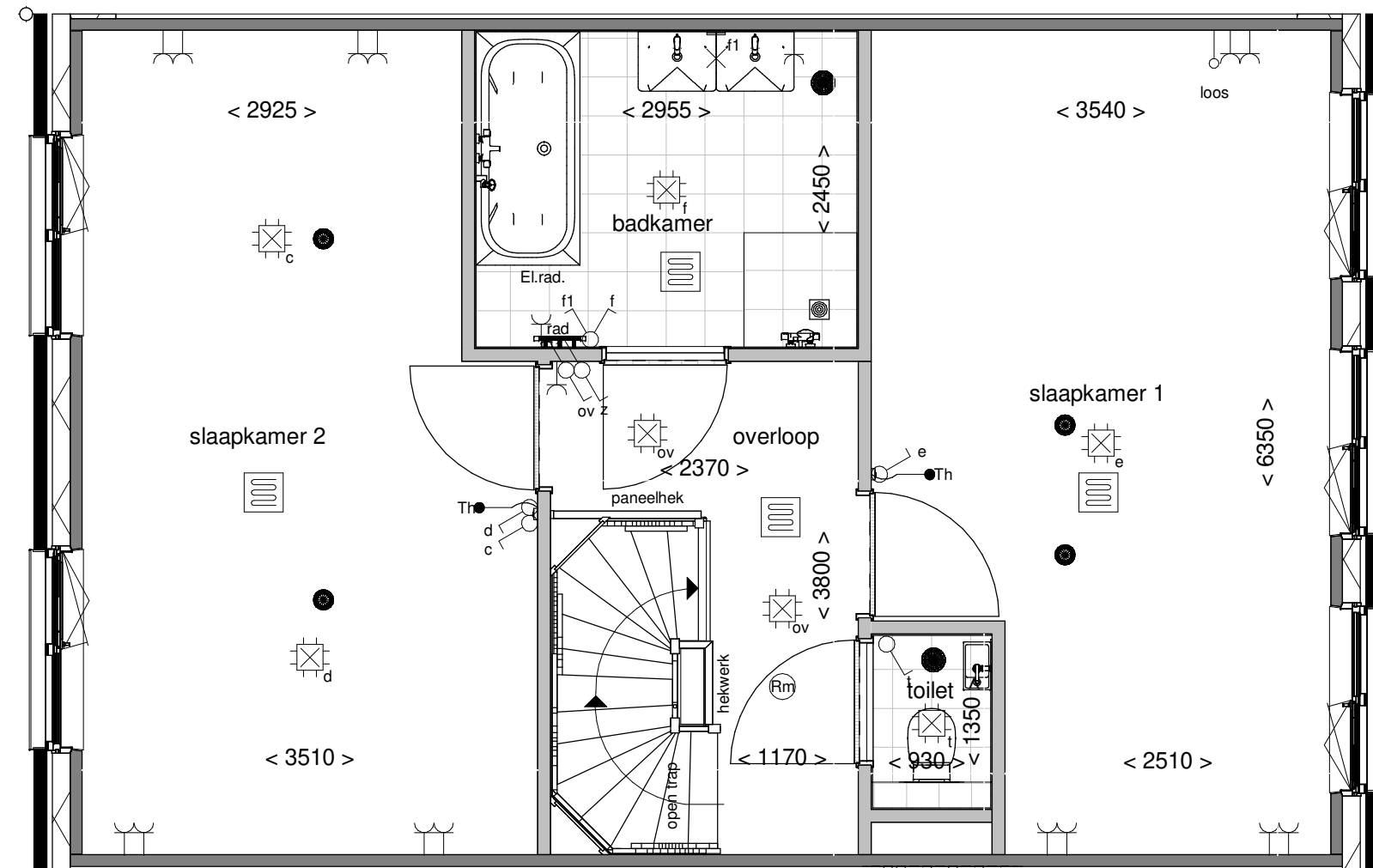

**ALLEMAAL
VIELEYAAL**

Optie: Samenvoegen
slaapkamer 2 en 3

Woningtype: W66

Bouwnummer: -

Optienummer: 1.C.W.32

Schaal: 1:50

Datum: 30-01-2024

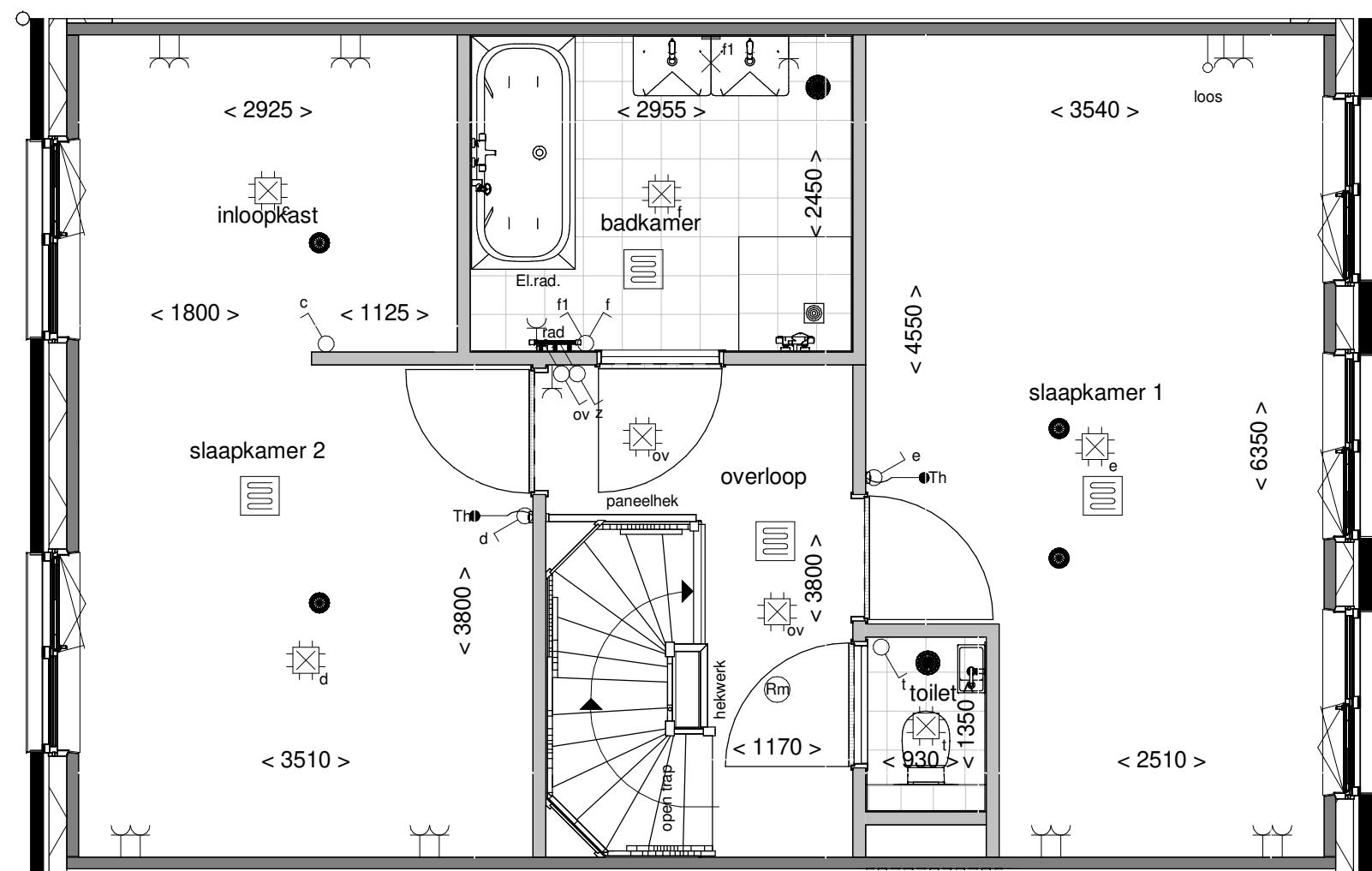

**ALLEMAAL
VIELEVAAL**

Optie: Samenv. slaapk. 2
en 3 met inloopkast

Woningtype: W66

Bouwnummer: -

Optienummer: 1.C.W.42

Schaal: 1:50

Datum: 30-01-2024

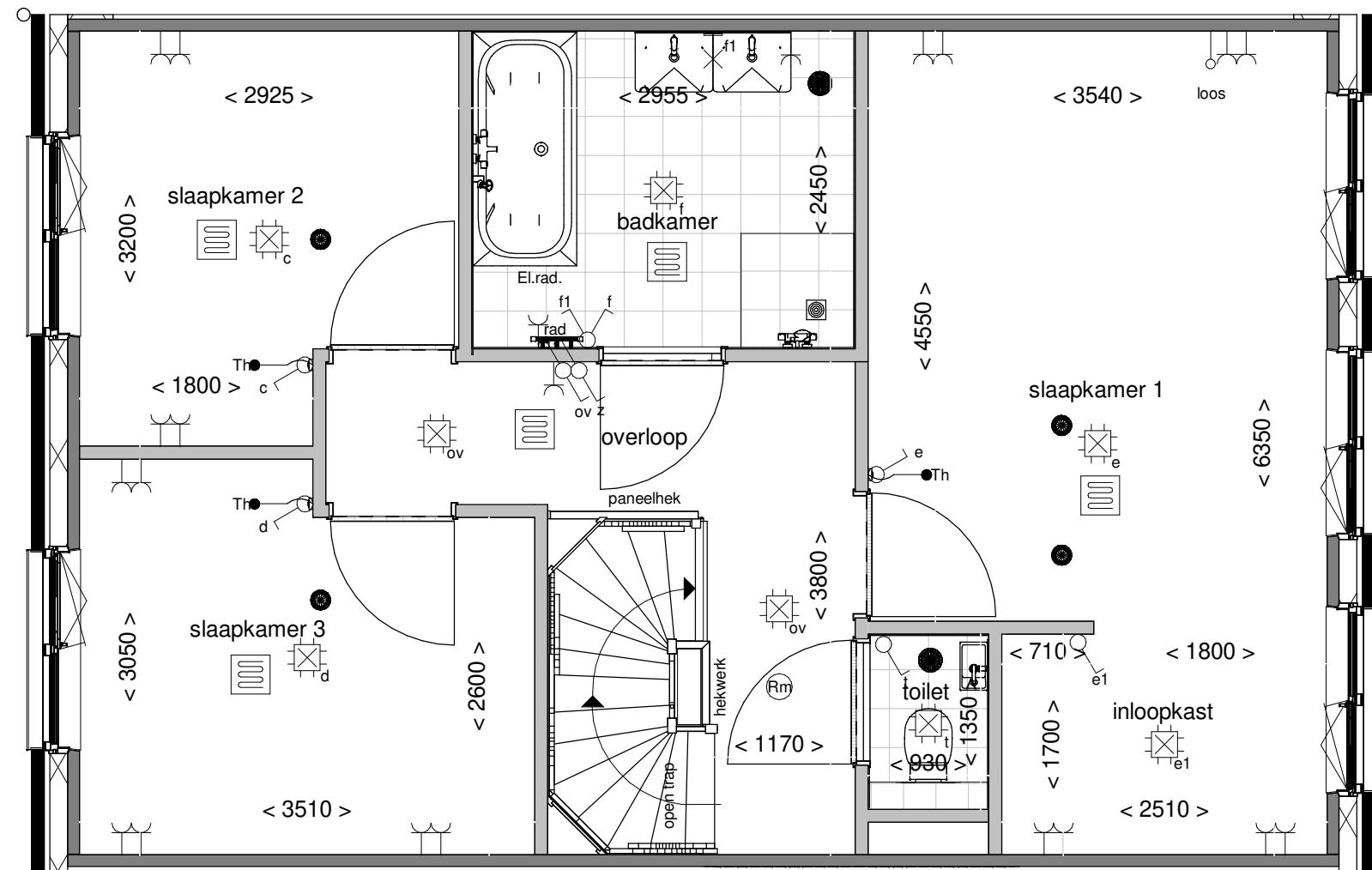

**ALLEMAAL
VIELEYAAL**

Optie: Inloopkast in slaapkamer 1

Woningtype: W66

Bouwnummer: -

Optienummer: 1.C.W.44

Schaal: 1:50

Datum: 30-01-2024

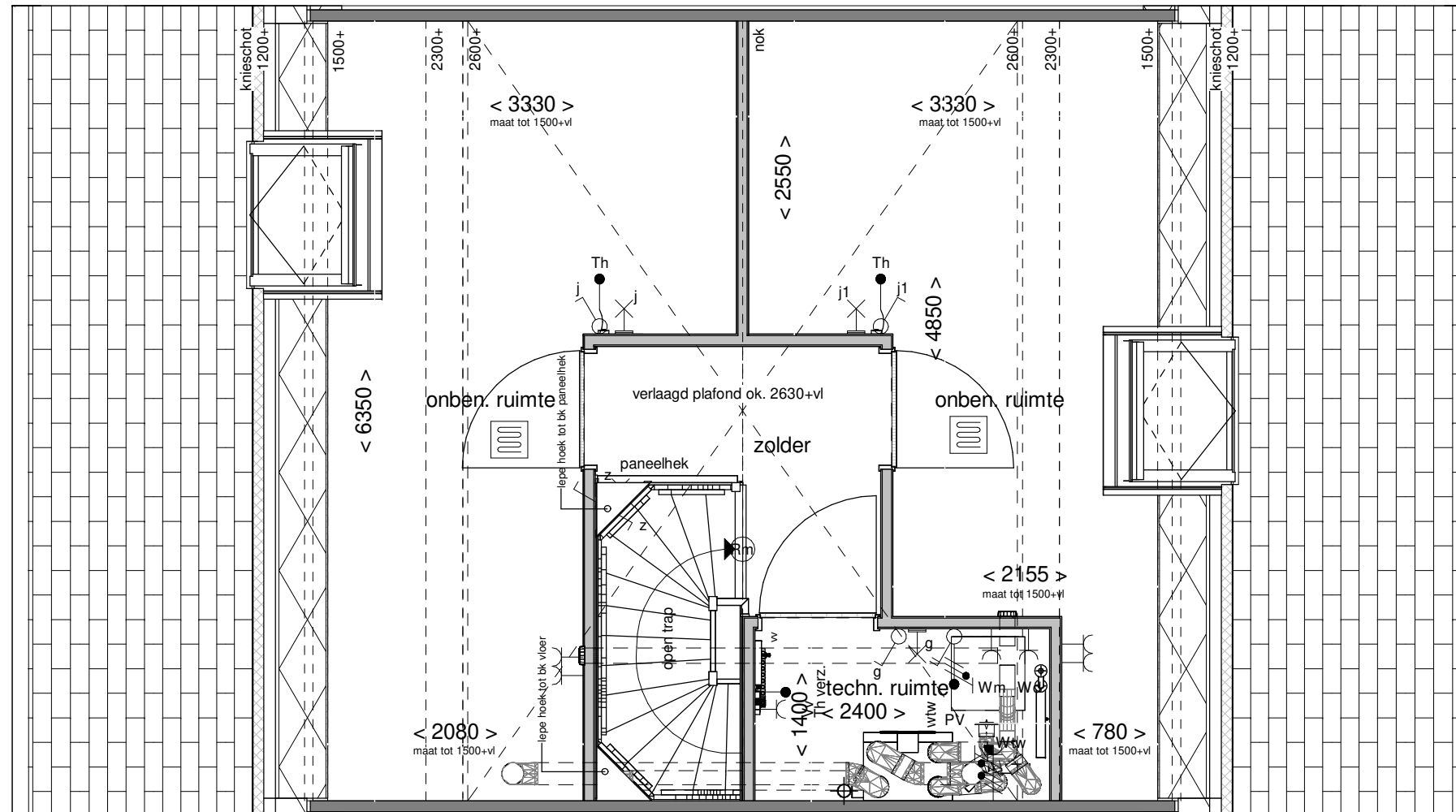

**ALLEMAAL
VIELEYAAL**

Optie: Indeling techn.- en 2
onb. ruimtes

Woningtype: W66

Bouwnummer: -

Optienummer: 1.C.W.76

Schaal: 1:50

Datum: 30-01-2024