

**ALLEMAAL
YIELEYAAL**

Tekening: Situatie Fase 5-6
 Woningtype: _____
 Bouwnummer: _____
 Bladnummer: VT-S-01
 Schaal: 1:1000
 Datum: 30-01-2024





Waldapad

Rollostraat

bnr: 231
158 m² bnr: 232
145 m² bnr: 233
145 m² bnr: 234
226 m²

X X X XU

Renvooi

-  - entree woning
-  - parkeervak eigen terrein
-  - erfgrans
-  - beplanting
type n.t.b. koper
-  - opstelplaats kliko
-  - tuinhekje
-  - klinkerbestrating
-  - betontegels
300x300mm
-  - groen strook
-  - haag h=900mm
-  - haag h=1800mm
-  - bamboehék h=1800mm
-  - gaashek met klimplanten
en poort h=1600mm
-  - klimplant











parkeerplekken en posities
bomen en struiken zijn indicatief



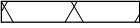

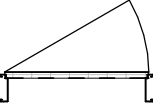
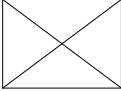



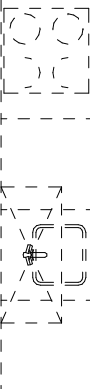





















**ALLEMAAL
YIELEYAAL**

Tekening: Situatie Blok K3
 Woningtype: XU, X
 Bouwnummer: 231-234
 Bladnummer: VT-S-11
 Schaal: 1:200
 Datum: 30-01-2024

Renvooi bouwkundig

	metselwerk kleur A
	dakpannen kleur oranje
	entree woning
	metselwerk
	isolatie
	dragende wand
	niet dragende binnenwand
	binnendeurkozijn (met bovenlicht)
	kruipluik
	opstelplaats wasmachine
	opstelplaats wasdroger
	
	principe opstelling keukenblok

Renvooi installaties

	aansluitpunt licht
	aansluitpunt licht, wand
	centraaldoos met lichtpunt
	armatuur aan de wand
	rookmelder
	aansluitpunt niet bedraad
	verdeelinrichting / meterkast / groepenkast
	beldrukker
	schel
	schakelaar, 1-polig
	werkschakelaar tbv PV-panelen
	schakelaar, 3-polig
	schakelaar, wissel
	schakelaar, kruis
	schakelaar, serie
	wandcontactdoos 1-voudig met beschermingscontact
	wandcontactdoos 2-voudig met beschermingscontact, verticaal
	wandcontactdoos 2-voudig met beschermingscontact
	thermostaatleiding, bedraad
	mechanische ventilatie-unit incl. warmteterugwinunit
	warmtepomp
	inblaasventiel mechanische ventilatie
	afzuigventiel mechanische ventilatie
	
	verdeler vloerverwarming
	Afleverzet stadswarmte
	ruimte voorzien van vloerverwarming
	elektrische radiator
	kanalen in het zicht

Disclaimer

De op deze tekeningen aangegeven maten zijn circa maten in millimeters en tussen de wanden / vloeren gemeten, waarbij geen rekening is gehouden met enige wandafwerking, plinten, aftimmering, ect. In verband met de nauwkeurige uitwerking van details, constructie, maatvoering, materialen e.d. kunnen er kleine afwijkingen ontstaan ten opzichte van de nu vermelde gegevens. Deze geringe afwijkingen geven geen aanleiding tot verrekening. Aan de op deze tekening aangegeven maten kunnen derhalve geen rechten worden ontleend. De op deze tekeningen aangegeven maatvoering is niet geschikt voor opdrachten aan derden door koper(s). De posities van aansluitingen en installatie onderdelen zijn indicatief op tekening aangegeven. De exacte aantallen en posities zullen na berekening in het werk door de installateurs worden bepaald en kunnen afwijken van deze tekening.

**ALLEMAAL
YIELEYAAL**

Tekening: Renvooi

Woningtype: -

Bouwnummer: -

Bladnummer: VT-0-00c

Schaal: -

Datum: 30-01-2024



Voorgevel



Achtergevel

ALLEMAAL
YIELEYAAL

Tekening: Gevels blok K3

Woningtype: X, XU

Bouwnummer: 231 t/m 234

Bladnummer: VT-K3-00a

Schaal: 1:150

Datum: 30-01-2024



Type: X
bwnr: 231

Linker zijgevel



Type: XU
bwnr: 234

Rechter zijgevel

**ALLEMAAL
YIELEYAAL**

Tekening: Zijgevels blok K3

Woningtype: X, XU

Bouwnummer: 231 t/m 234

Bladnummer: VT-K3-00b

Schaal: 1:100

Datum: 30-01-2024

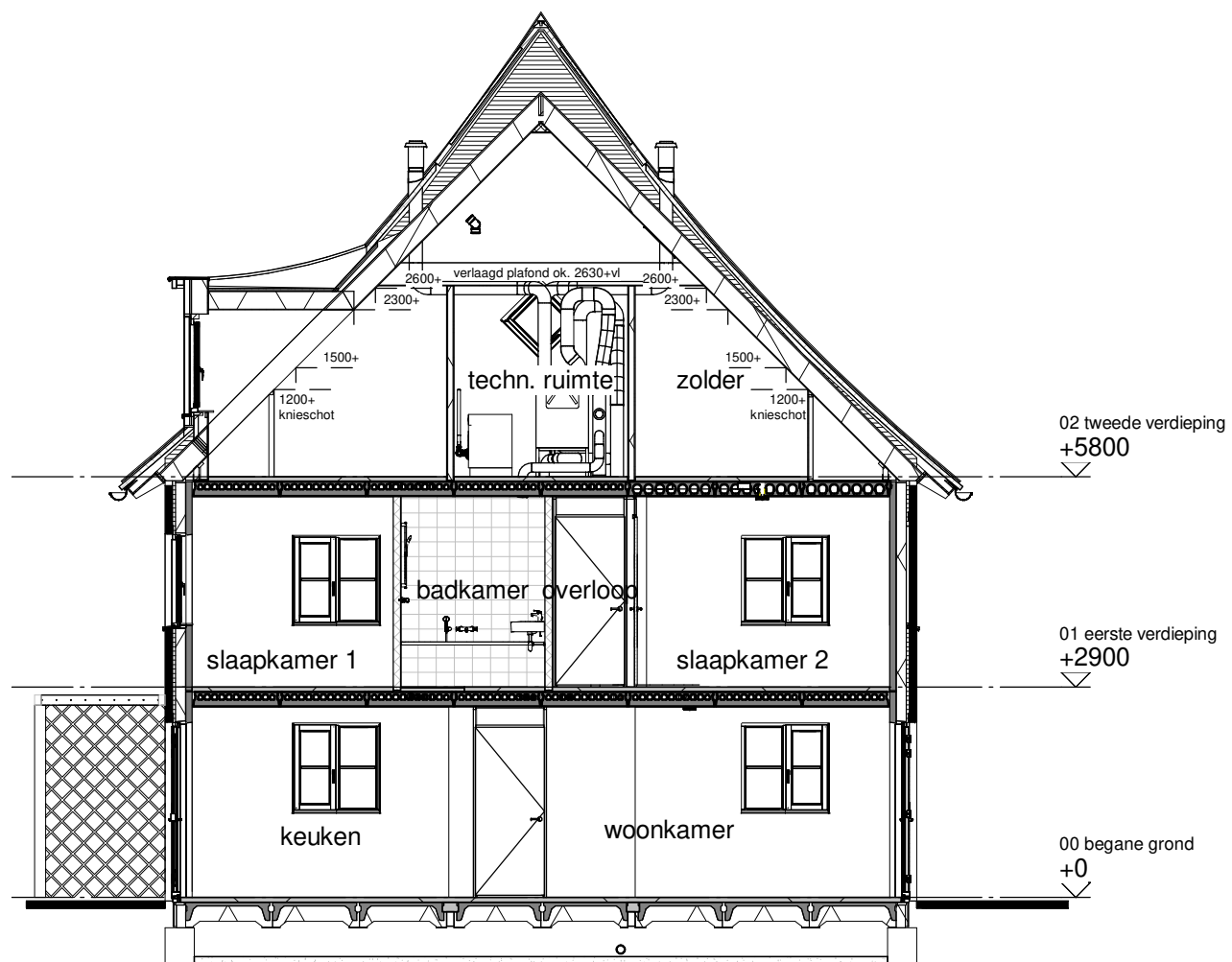

Doorsnede A

Type: X
Bouwnummer: 231

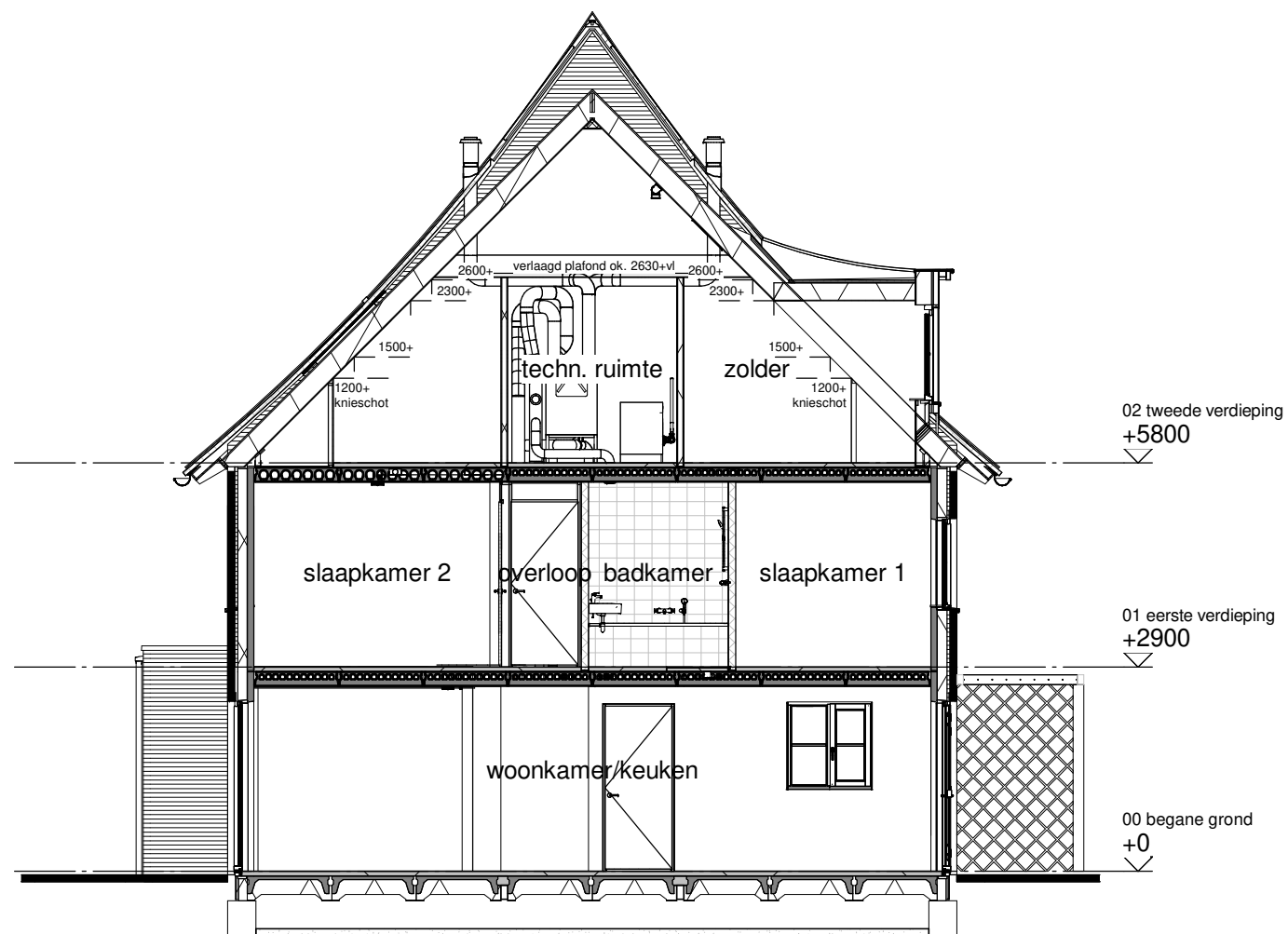

Doorsnede B

Type: XU
Bouwnummer: 234

**ALLEMAAL
YIELEYAAL**

Tekening: Doorsnedes blok K3

Woningtype: X, XU

Bouwnummer: 231 t/m 234

Bladnummer: VT-K3-00c

Schaal: 1:100

Datum: 30-01-2024

Tekening: Begane grond

Woningtype: XU

Bouwnummer: 234

Bladnummer: VT-K3-234a

Schaal: 1:50

Datum: 30-01-2024

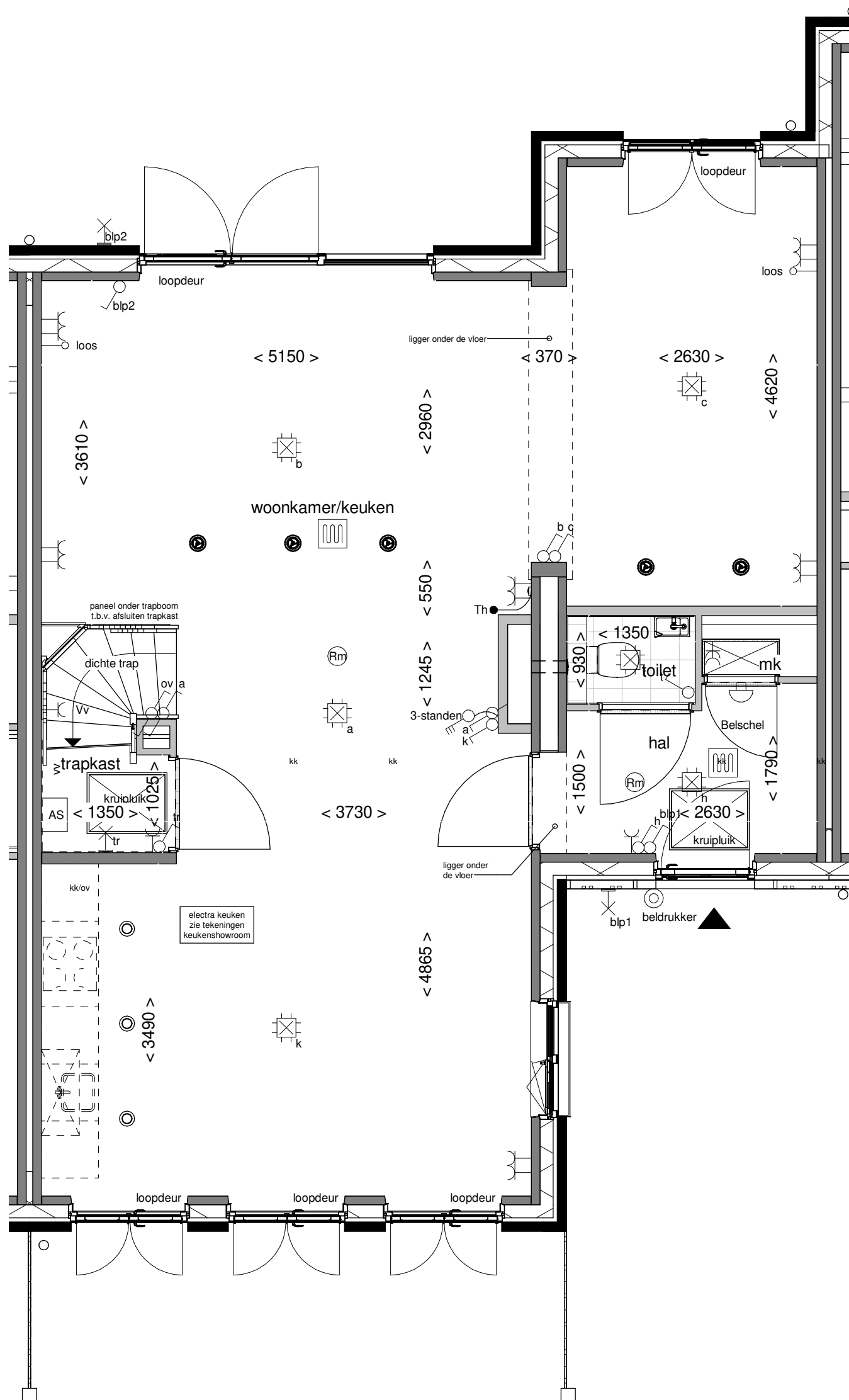

Tekening: Eerste verdieping

Woningtype: XU

Bouwnummer: 234

Bladnummer: VT-K3-234b

Schaal: 1:50

Datum: 30-01-2024

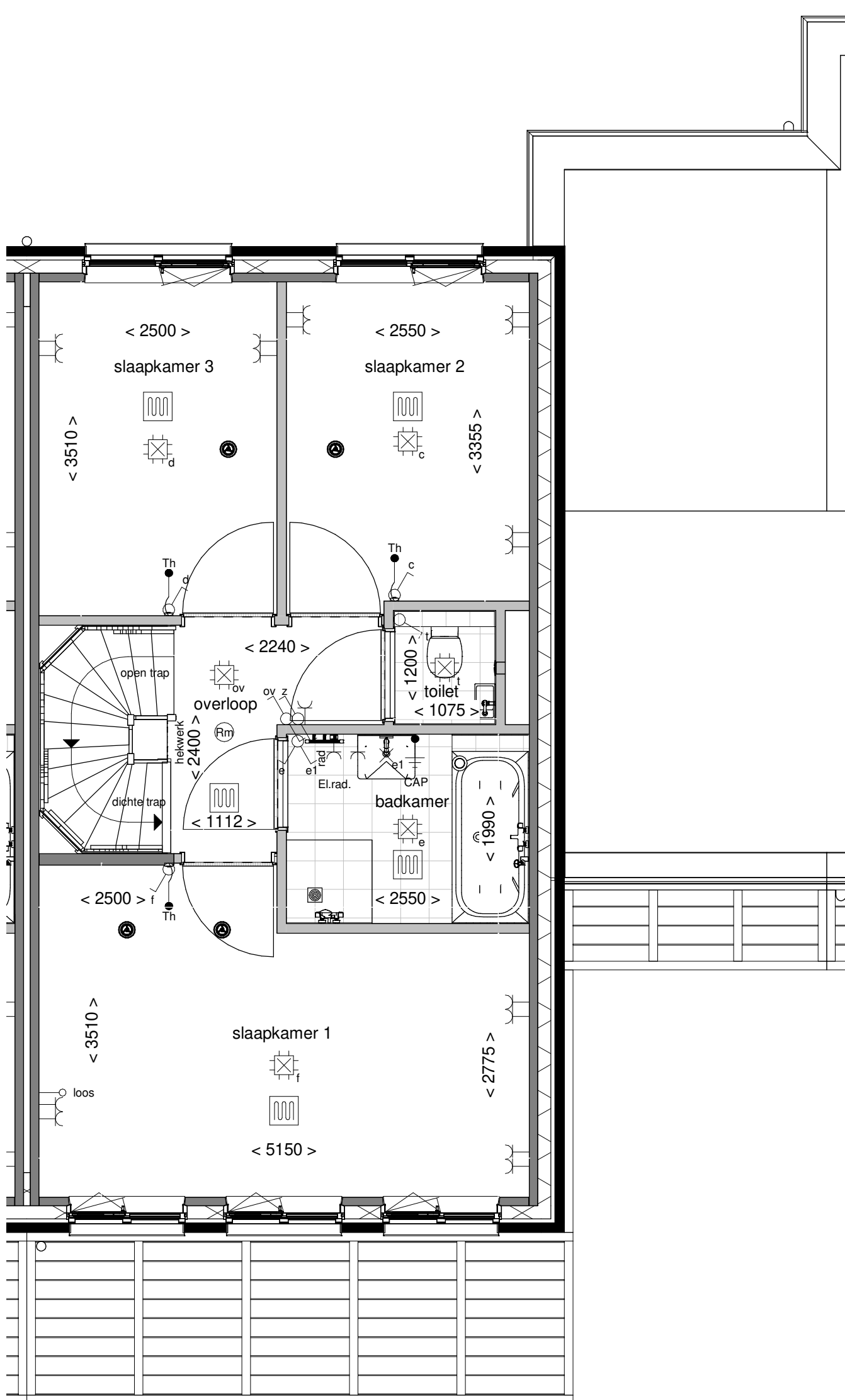

Tekening: Tweede verdieping

Woningtype: XU

Bouwnummer: 234

Bladnummer: VT-K3-234C

Schaal: 1:50

Datum: 30-01-2024

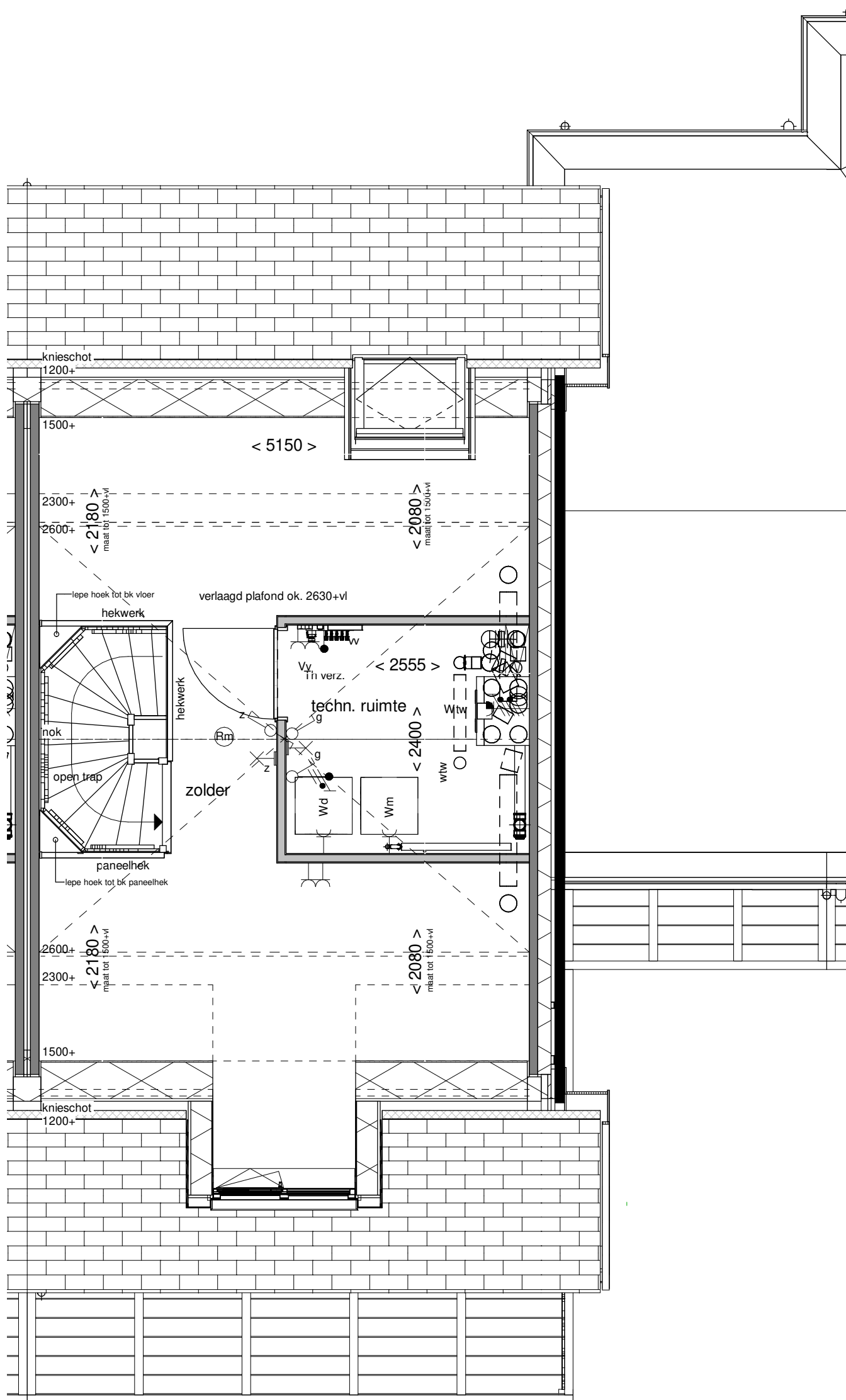

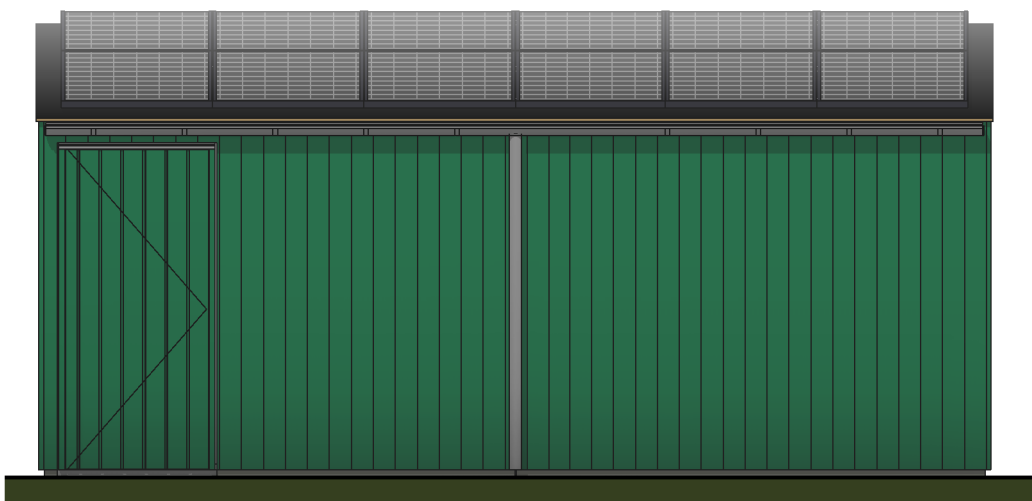

Voorgevel

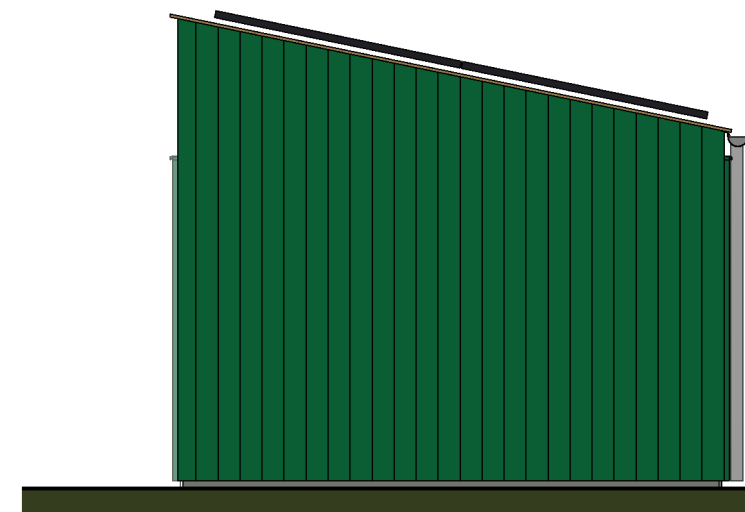

Linker zijgevel

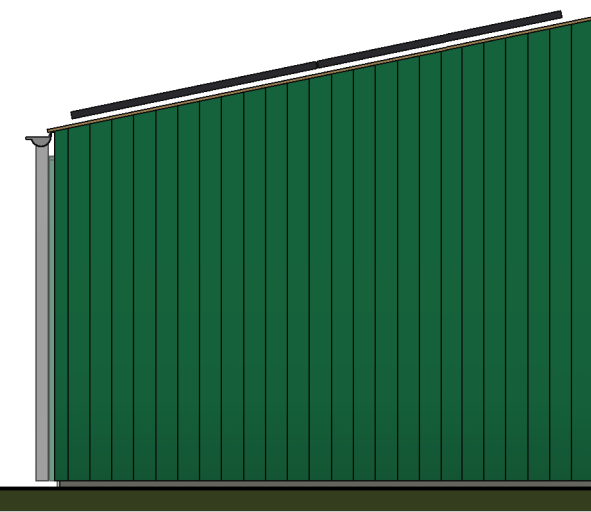

Rechter zijgevel

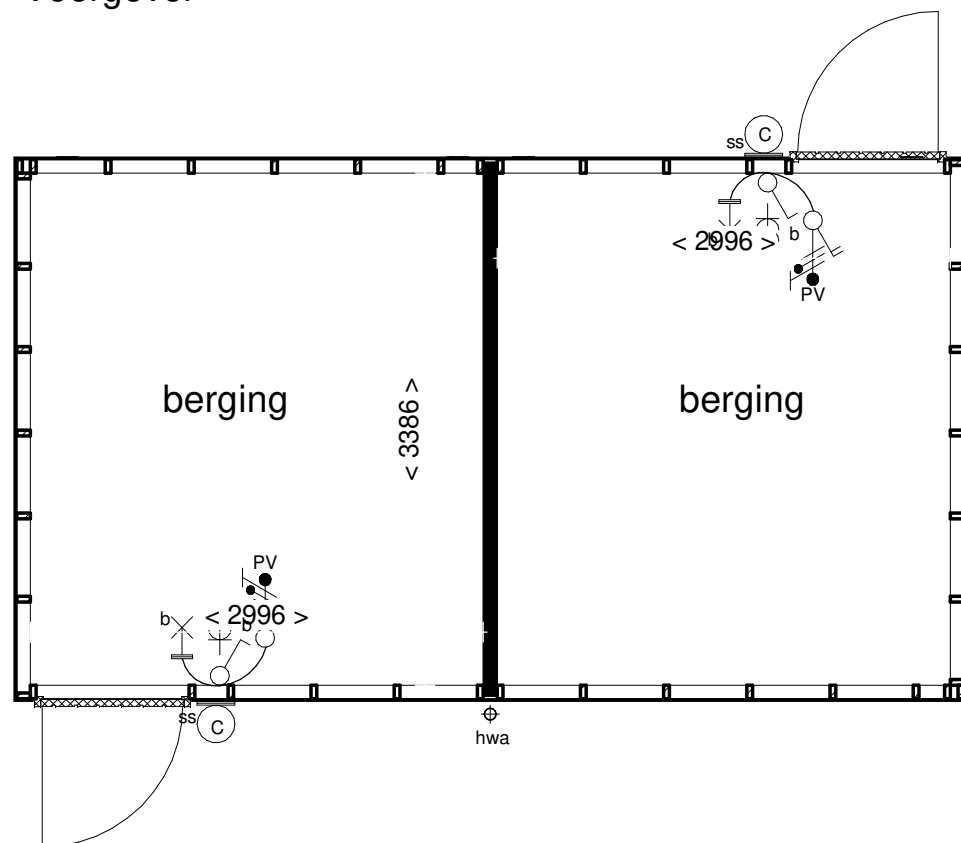

Begane grond

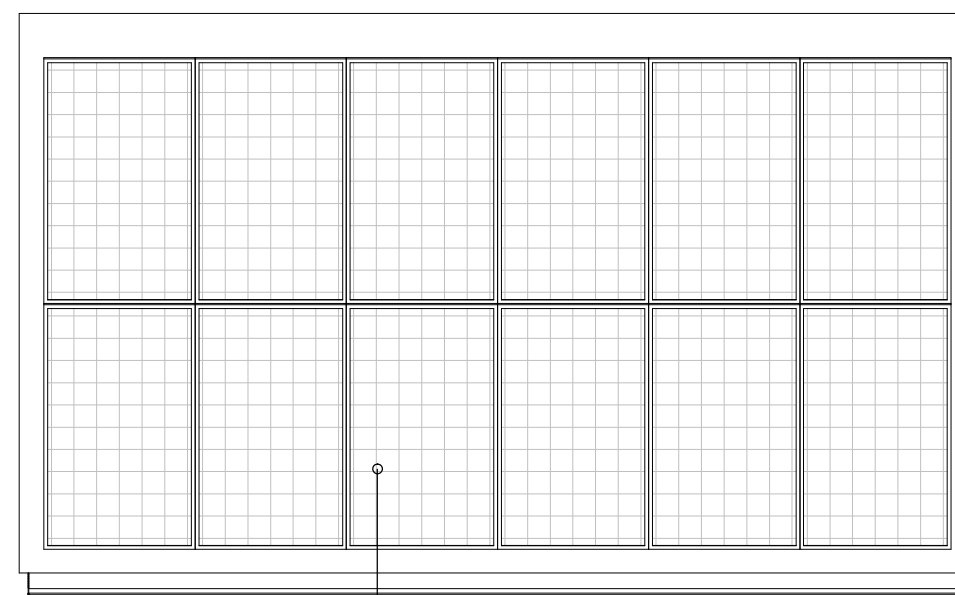

Dakaanzicht

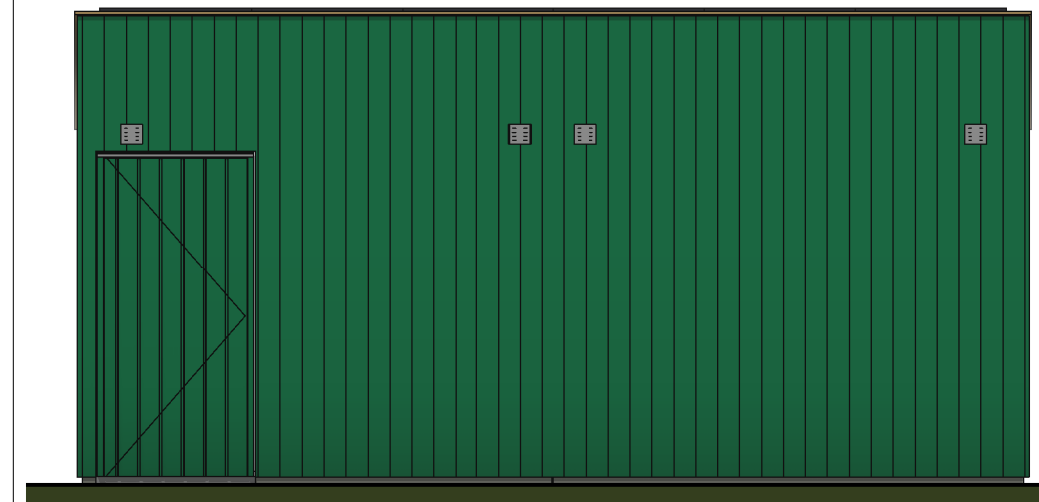

Achtergevel

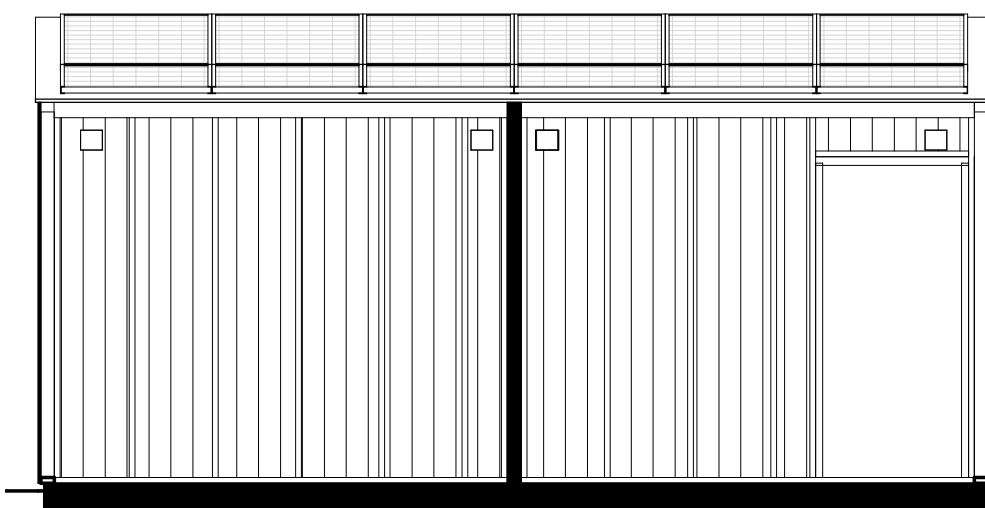

Doorsnede A-A

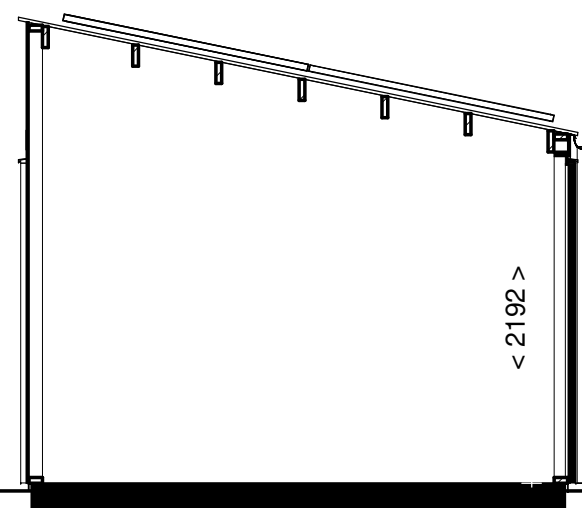

Doorsnede B-B



3D aanzicht

Als getekend:	Gespiegeld:
bnr. 300 - 301	bnr. 231 - 232
bnr. 302 - 303	bnr. 233 - 234
bnr. 304 - 305	bnr. 244 - 245
	bnr. 242 - 243
	bnr. 246 - 247
	bnr. 248 - 249

**ALLEMAAL
YIELEYAAL**

Tekening: **Berging B**

Woningtype: -

Bouwnummer:

Bladnummer: **VT-BE02**

Schaal: **1:50**

Datum: **30-01-2024**

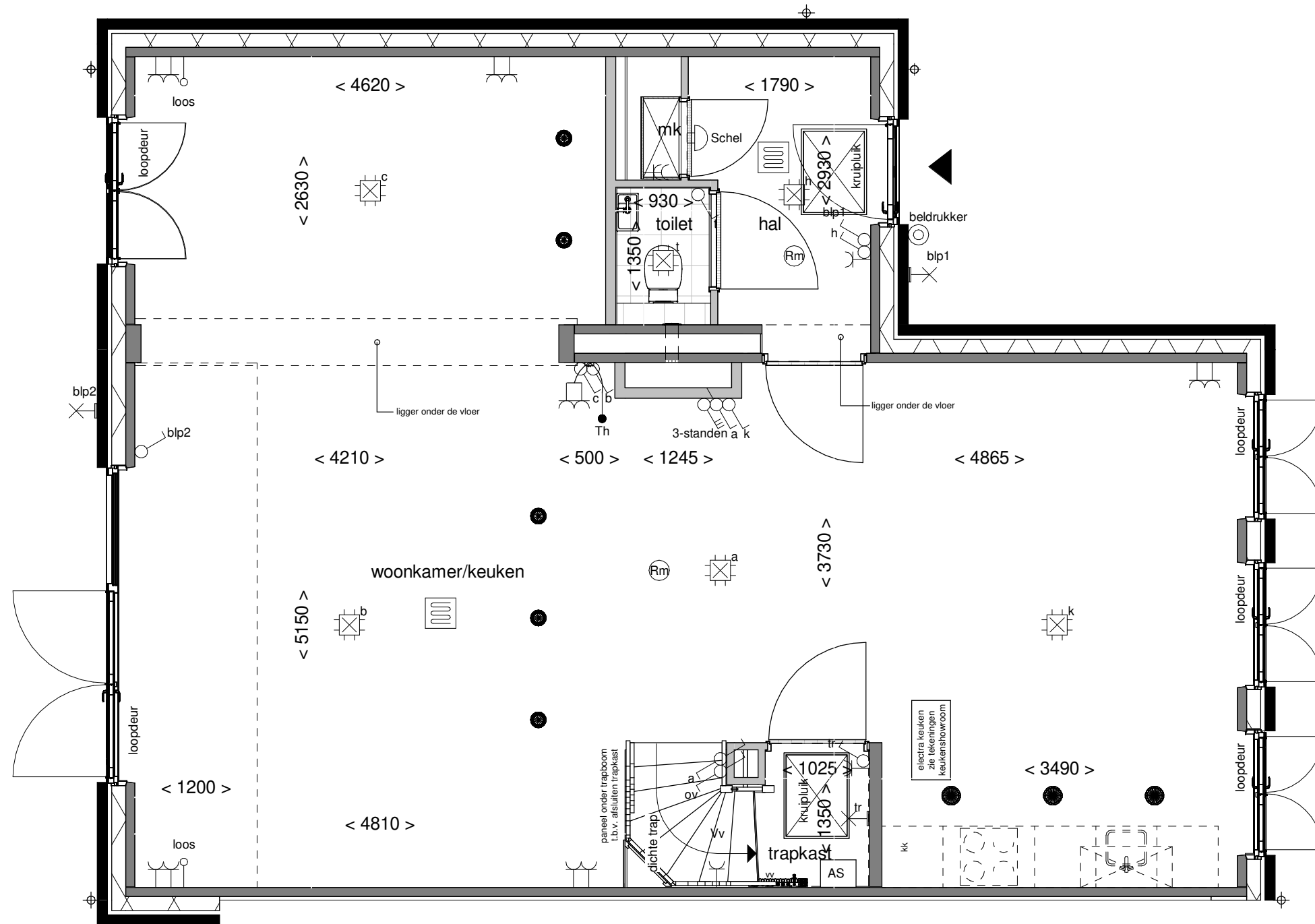

Achtergevel schaal 1:100

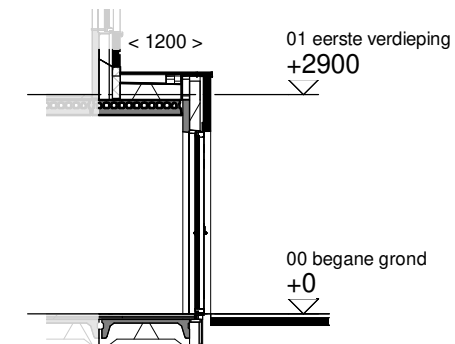

Doorsnede schaal 1:100

**ALLEMAAL
YIELEYAAL**

Optie: **Uitbouw achtergevel
1200mm**

Woningtype: **X54U**

Bouwnummer: -

Optienummer: **1.A.X.12**

Schaal: **1:50 / 1:100**

Datum: **30-01-2024**

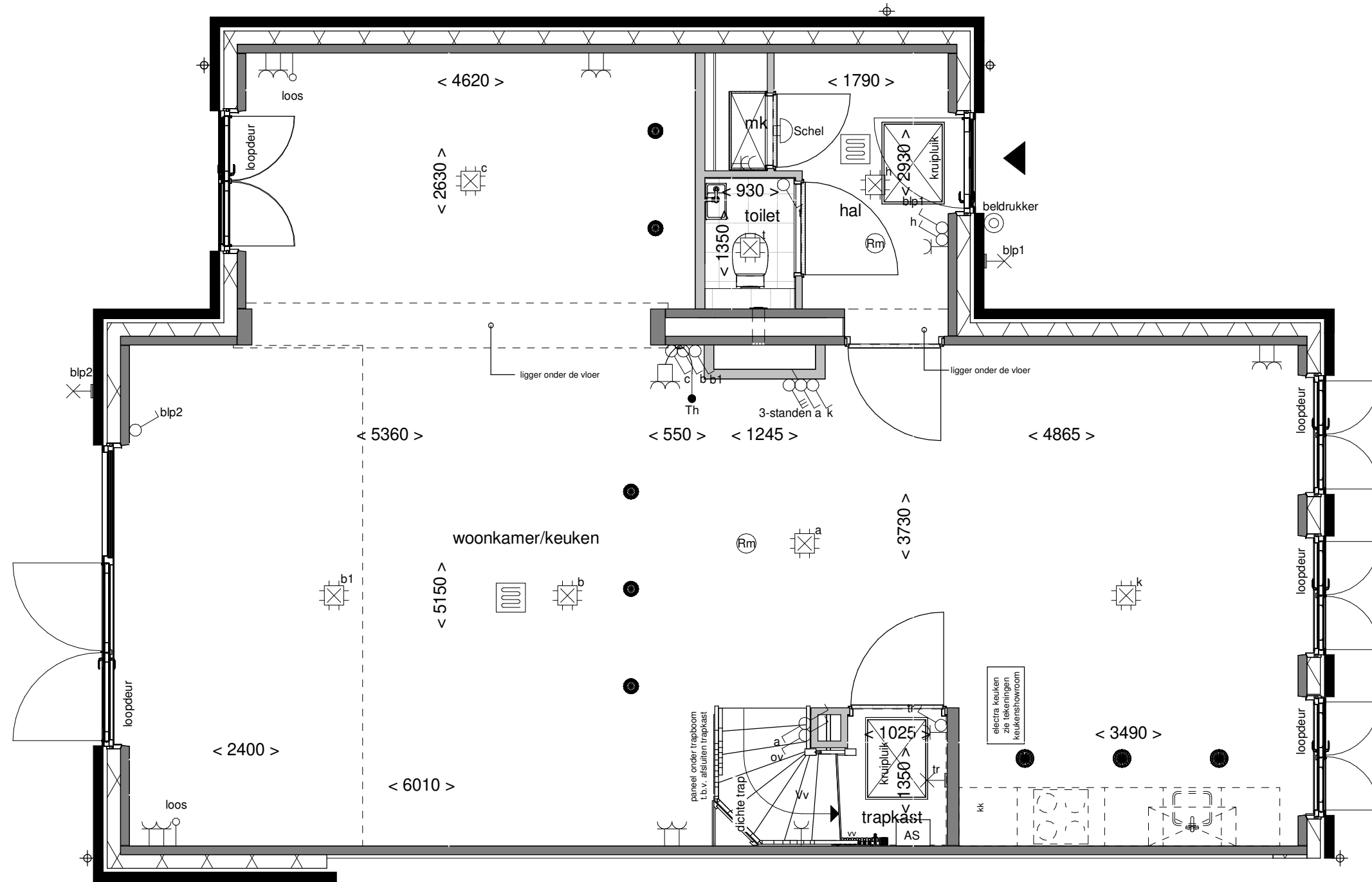

Achtergevel schaal 1:100

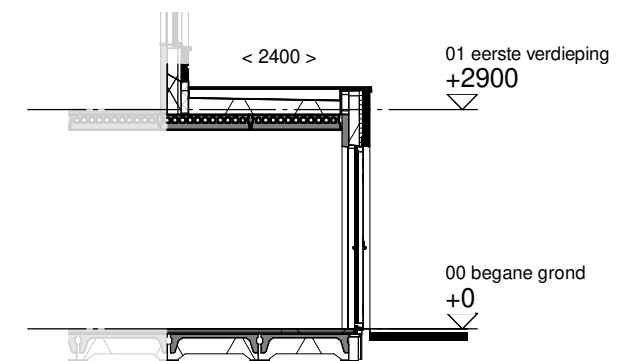

Doorsnede schaal 1:100

**ALLEMAAL
VIELEYAAL**

Optie: **Uitbouw achtergevel
2400mm**

Woningtype: **X54U**

Bouwnummer: -

Optienummer: **1.A.X.32**

Schaal: **1:50 / 1:100**

Datum: **30-01-2024**

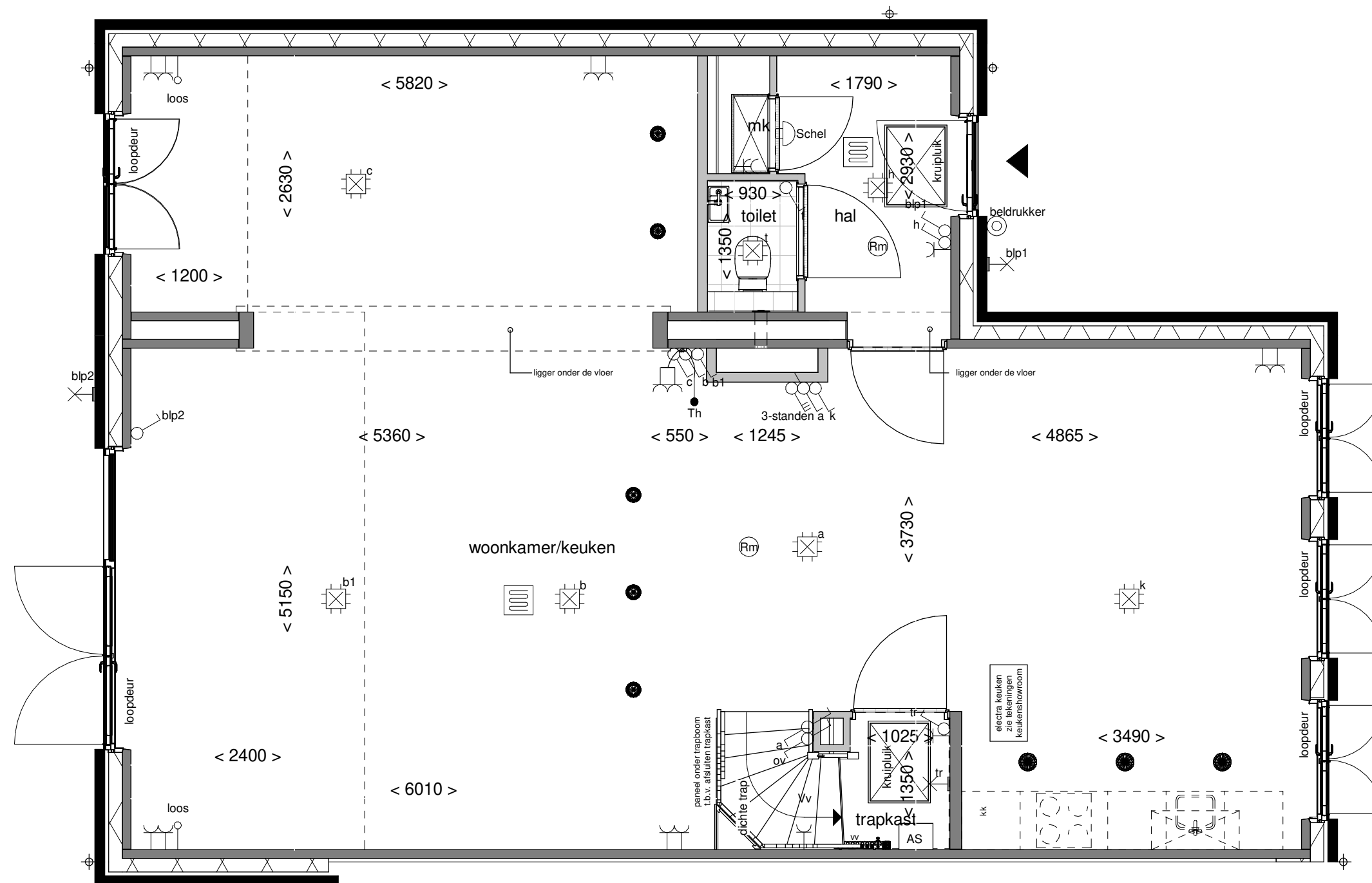

Achtergevel schaal 1:100

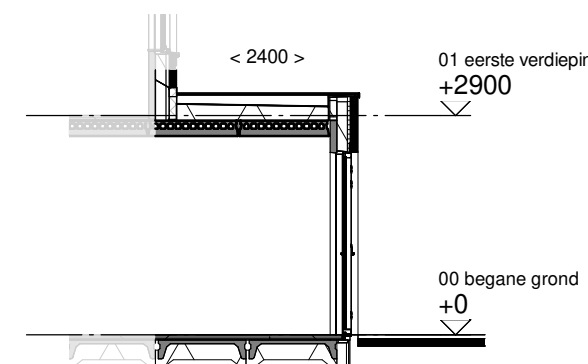

Doorsnede schaal 1:100

**ALLEMAAL
YIELEYAAL**

Optie: Uitb. achter 2400mm
+ zijuitbouw 1200mm

Woningtype: X54U

Bouwnummer: -

Optienummer: 1.A.X.52B

Schaal: 1:50 / 1:100

Datum: 30-01-2024

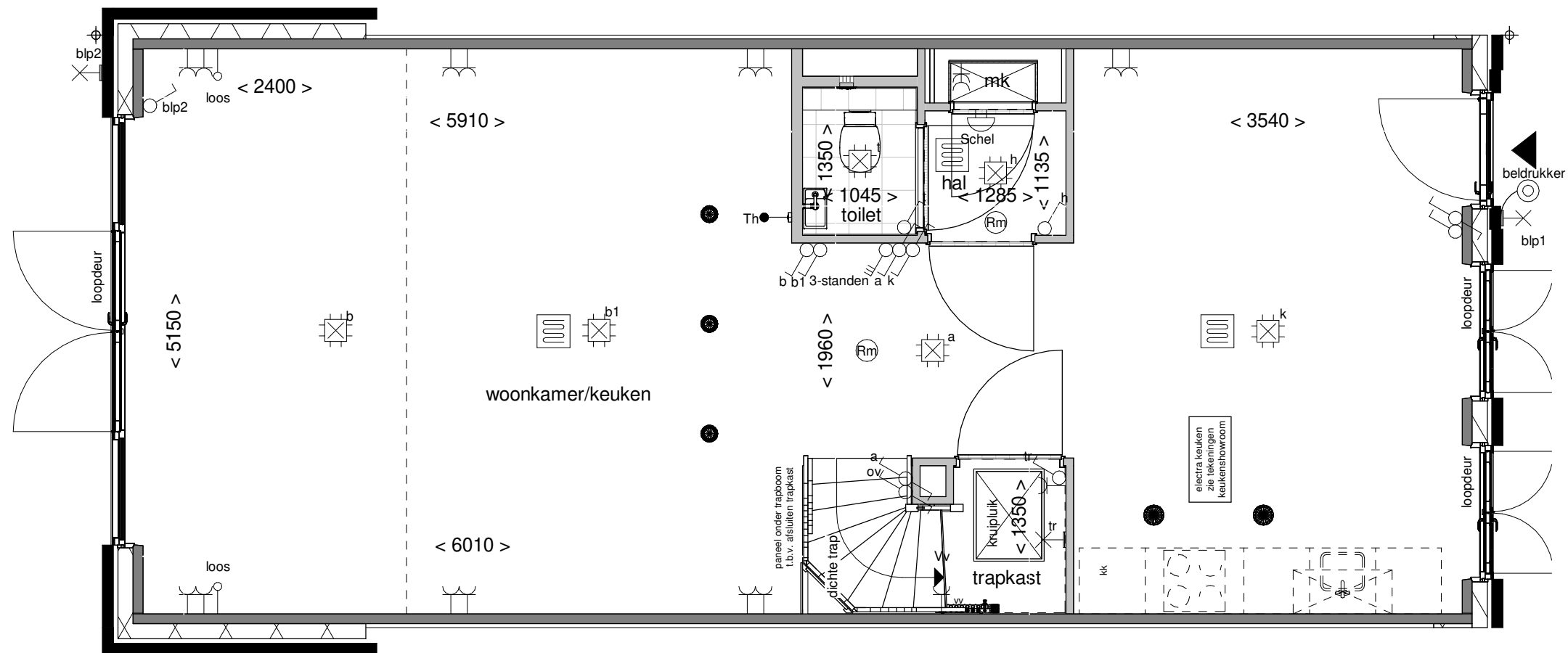

Achtergevel schaal 1:100

**ALLEMAAL
YIELEYAAL**

Optie: Dubbele deuren
achtergevel 3900mm

Woningtype: X54

Bouwnummer: -

Optienummer: 1.A.X.62

Schaal: 1:50 / 1:100

Datum: 30-01-2024

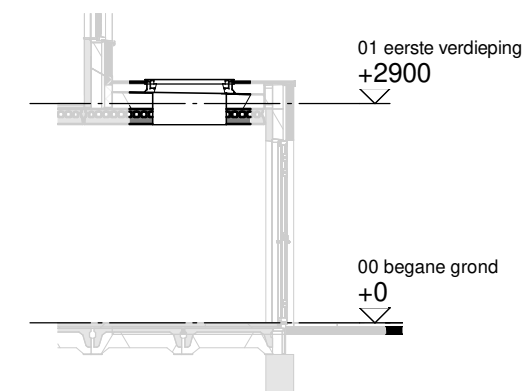
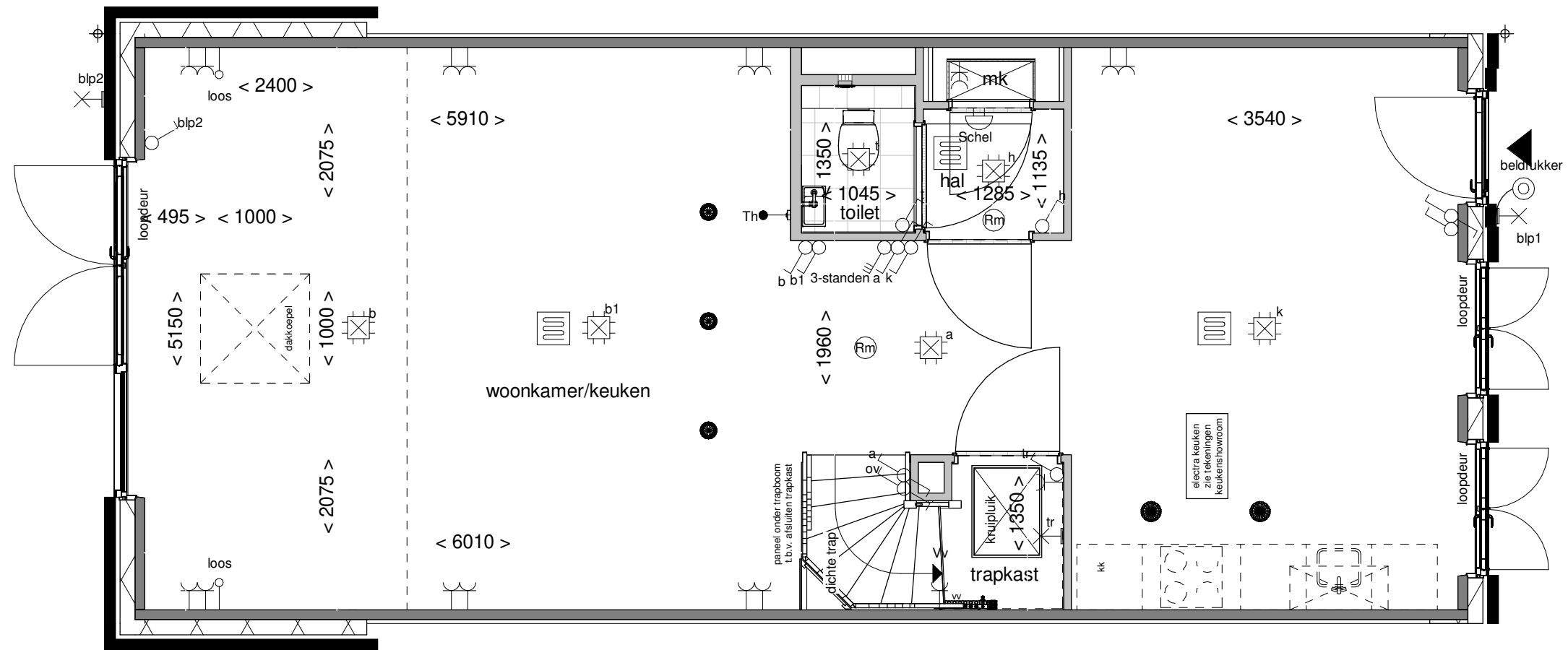

Doorsnede schaal 1:100

**ALLEMAAL
VIELEYAAL**

Optie: Lichtkoepel in uitbouw 2400mm

Woningtype: X54

Bouwnummer: -

Optienummer: 1.B.X.10

Schaal: 1:50 / 1:100

Datum: 30-01-2024

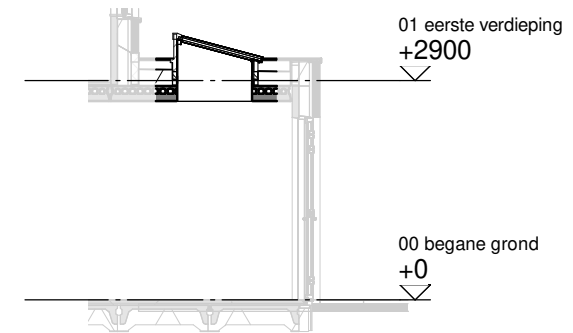
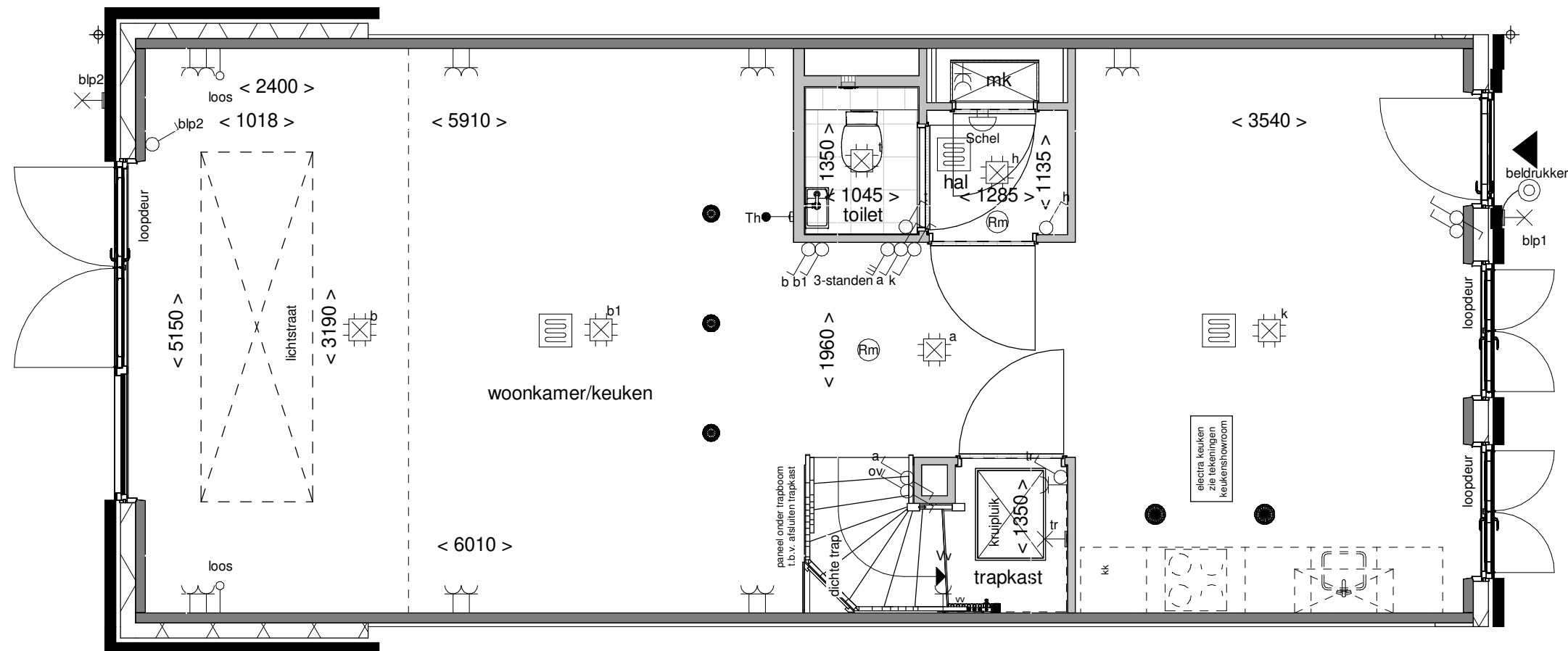

Doorsnede schaal 1:100

**ALLEMAAL
VIELEYAAL**

Optie: Lichtstraat in uitbouw
2400mm

Woningtype: X54

Bouwnummer: -

Optienummer: 1.B.X.14

Schaal: 1:50 / 1:100

Datum: 30-01-2024

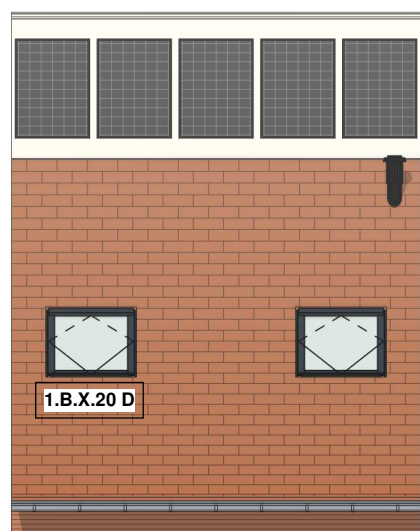
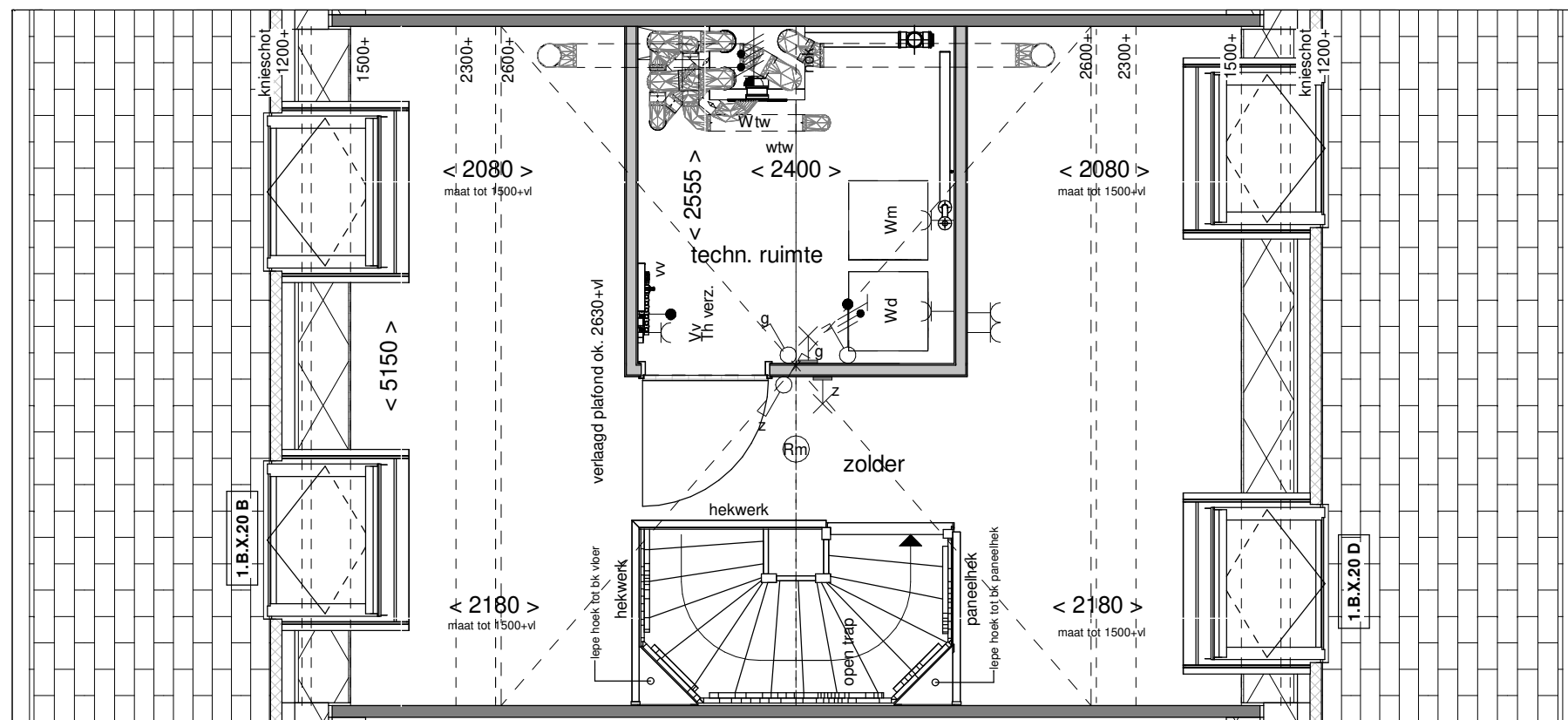

Voorgevel schaal 1:100

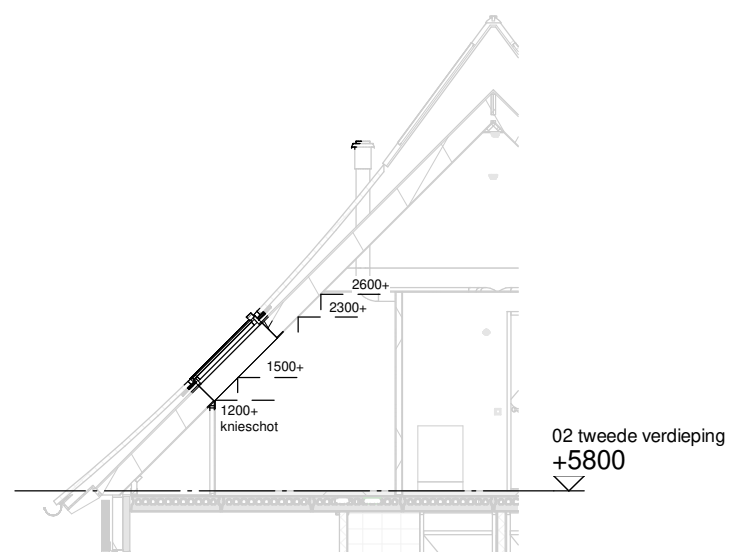

Doorsnede schaal 1:100

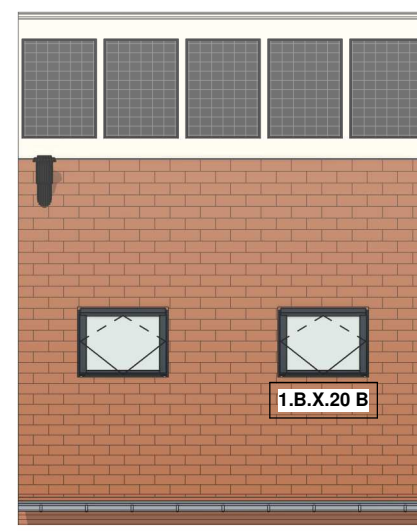

Achtergevel schaal 1:100

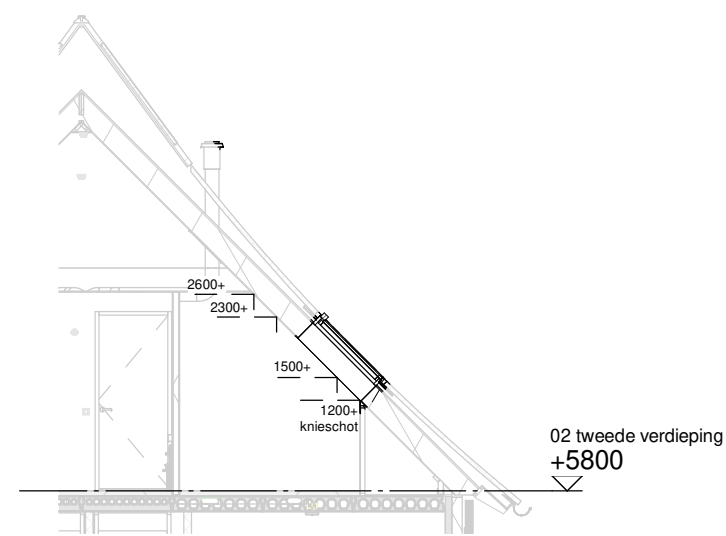

Doorsnede schaal 1:100

**ALLEMAAL
YIELEYAAL**

Optie: Dakramen voor- en achtergevel

Woningtype: X54

Bouwnummer: -

Optienummer: 1.B.X.20

Schaal: 1:50 / 1:100

Datum: 30-01-2024

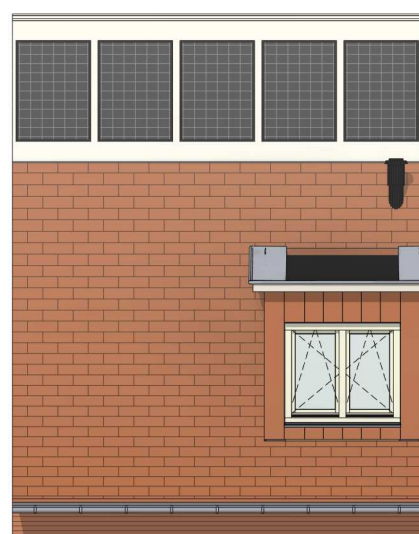
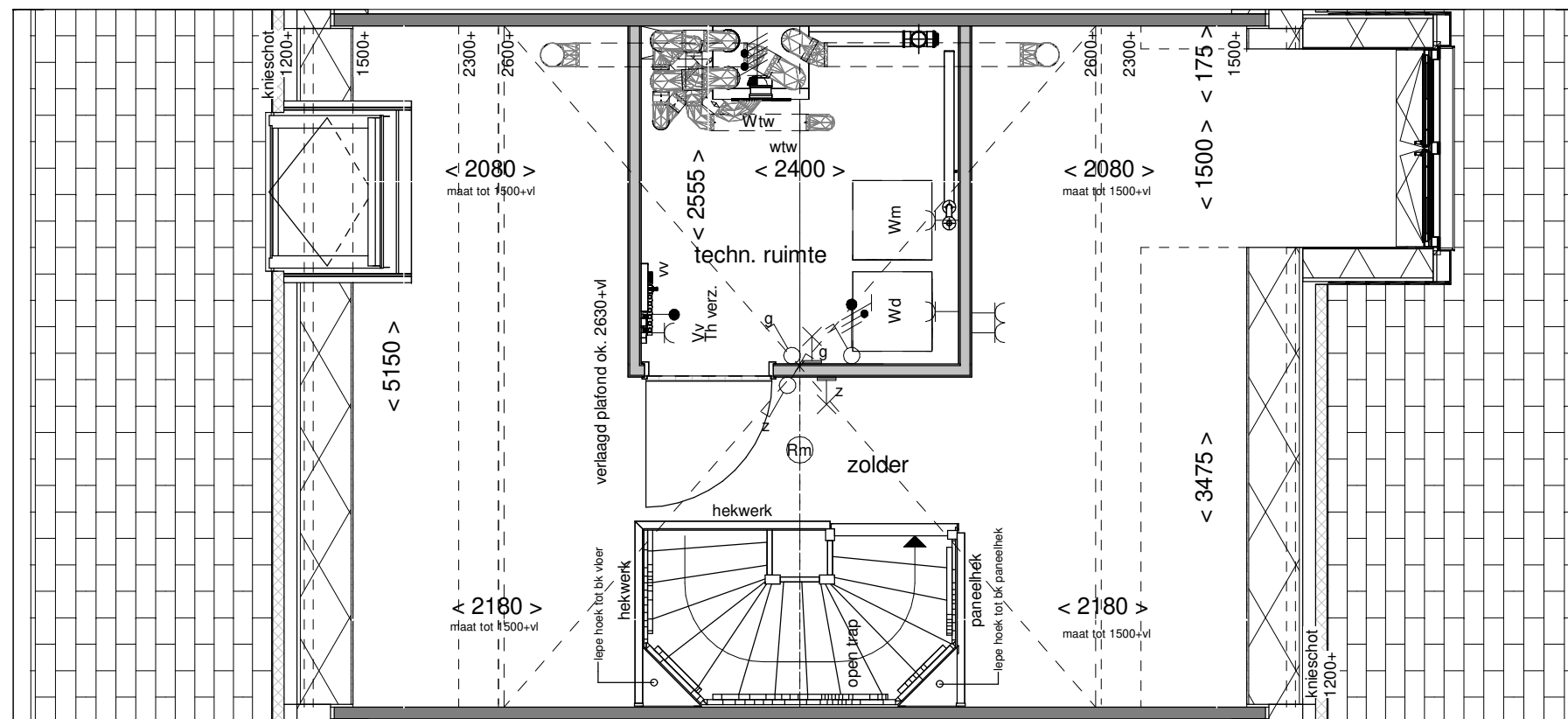

Voorgevel schaal 1:100

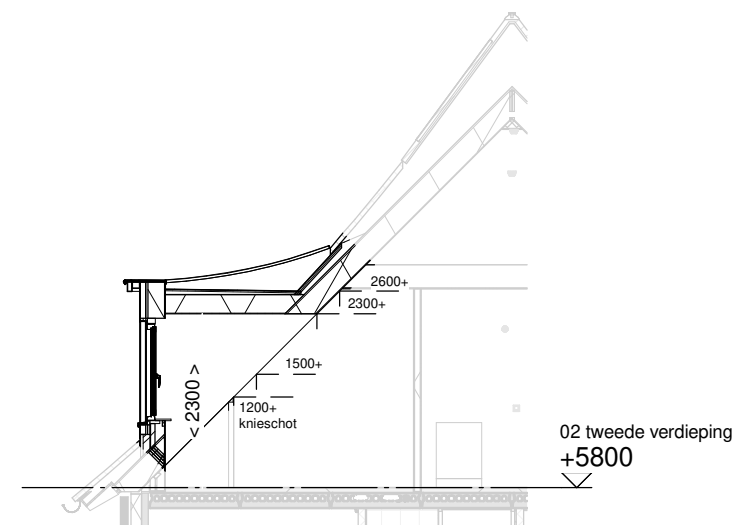

Doorsnede schaal 1:100

**ALLEMAAL
VIELEYAAL**

Optie: Dakkapel
voorgevel 1500mm

Woningtype: X54

Bouwnummer: -

Optienummer: 1.B.X.33

Schaal: 1:50 / 1:100

Datum: 30-01-2024

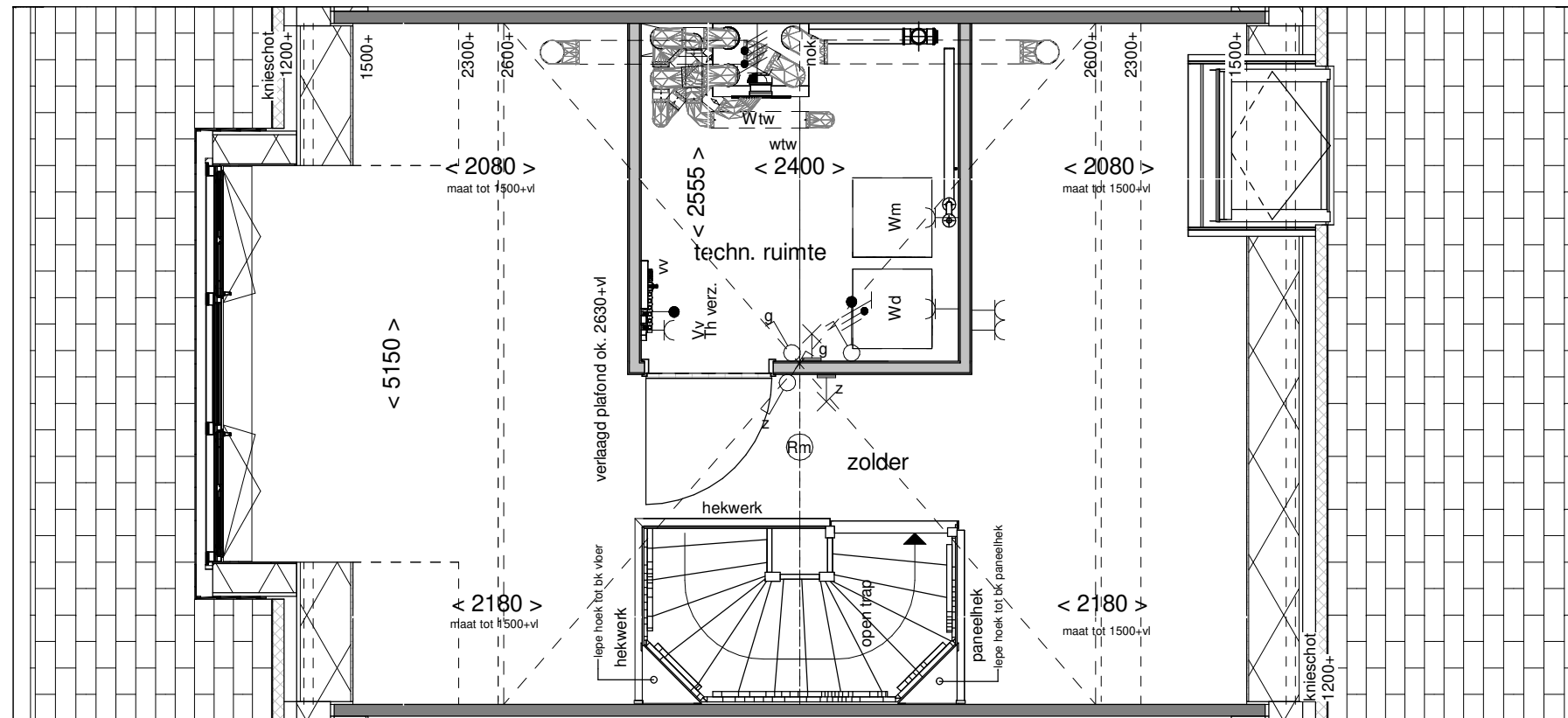

Achtergevel schaal 1:100

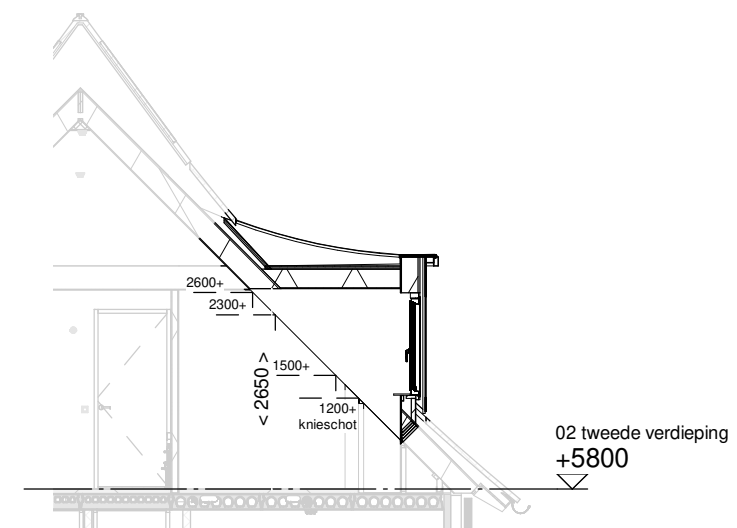

Doorsnede schaal 1:100

**ALLEMAAL
YIELEYAAL**

Optie: Dakkapel
achtergevel 3000mm

Woningtype: X54

Bouwnummer: -

Optienummer: 1.B.X.34

Schaal: 1:50 / 1:100

Datum: 30-01-2024

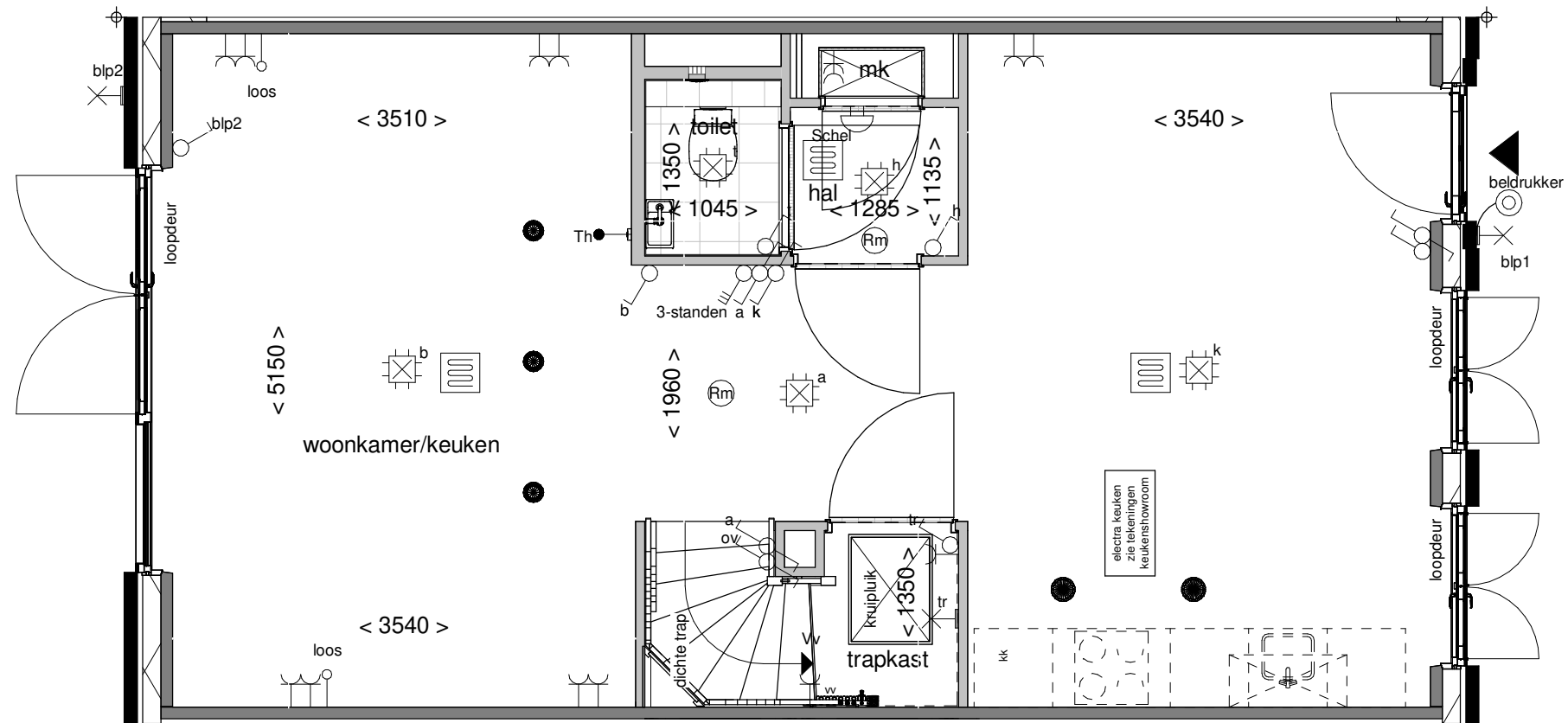

**ALLEMAAL
VIELEYAAL**

Optie: **Wand naast trap**

Woningtype: **X54**

Bouwnummer: -

Optienummer: **1.C.X.10**

Schaal: **1:50**

Datum: **30-01-2024**

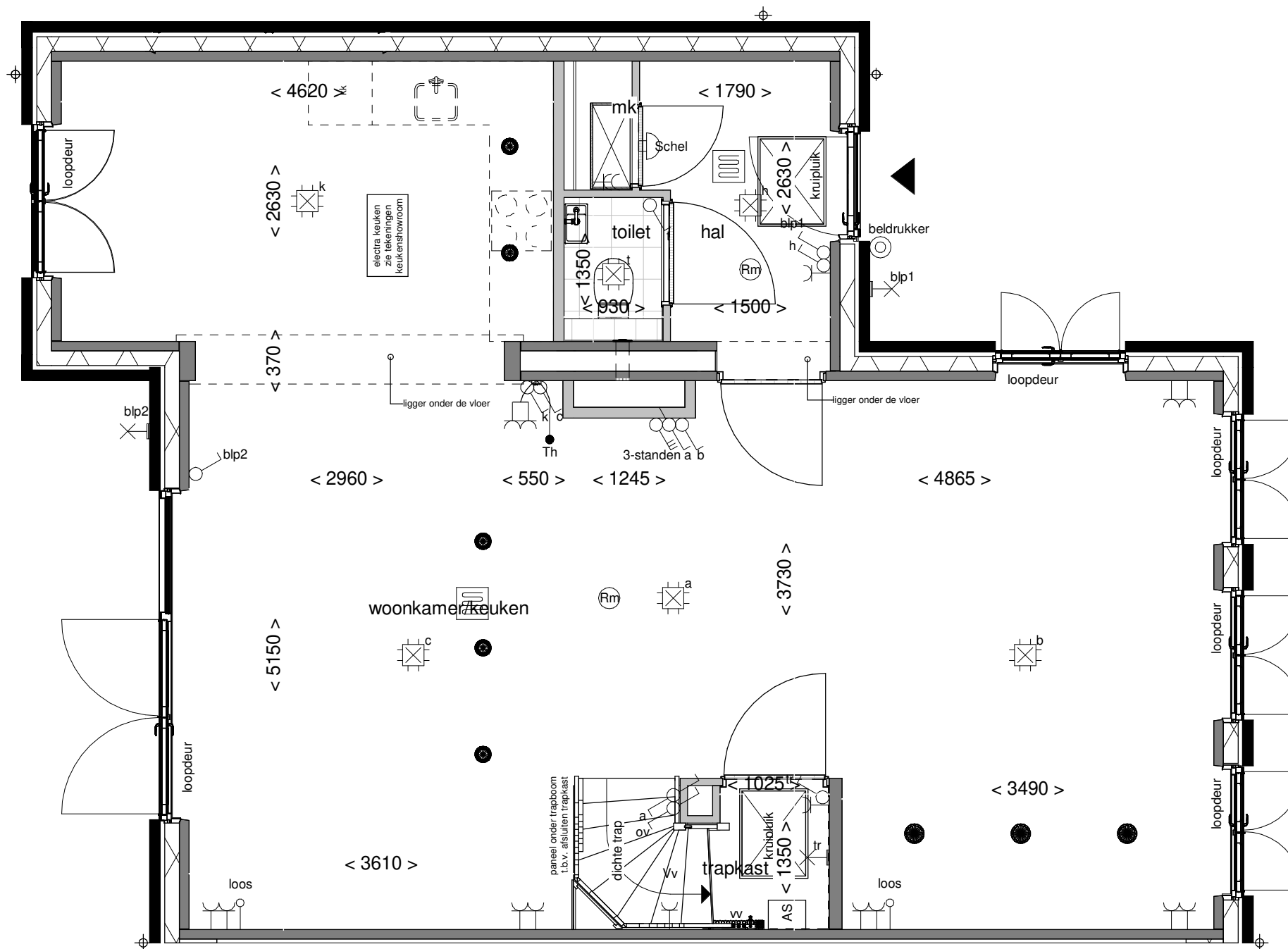

**ALLEMAAL
VIELEVAAL**

Optie: Keuken in zij-uitbouw

Woningtype: X54U

Bouwnummer: -

Optienummer: 1.C.X.12

Schaal: 1:50

Datum: 30-01-2024

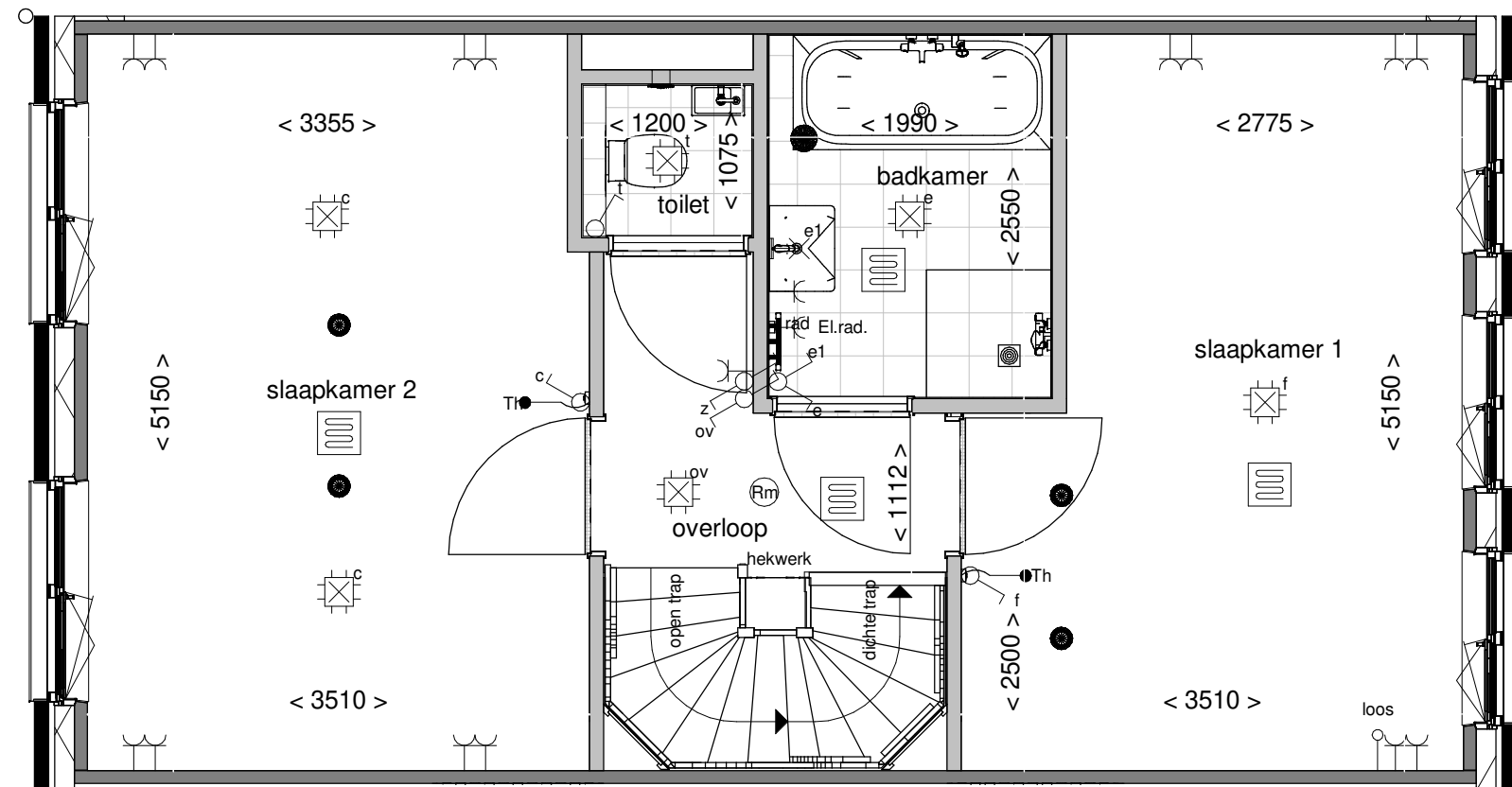

**ALLEMAAL
VIELEVAAL**

Optie: Samenvoegen
slaapkamer 2 en 3

Woningtype: X54

Bouwnummer: -

Optienummer: 1.C.X.30

Schaal: 1:50

Datum: 30-01-2024

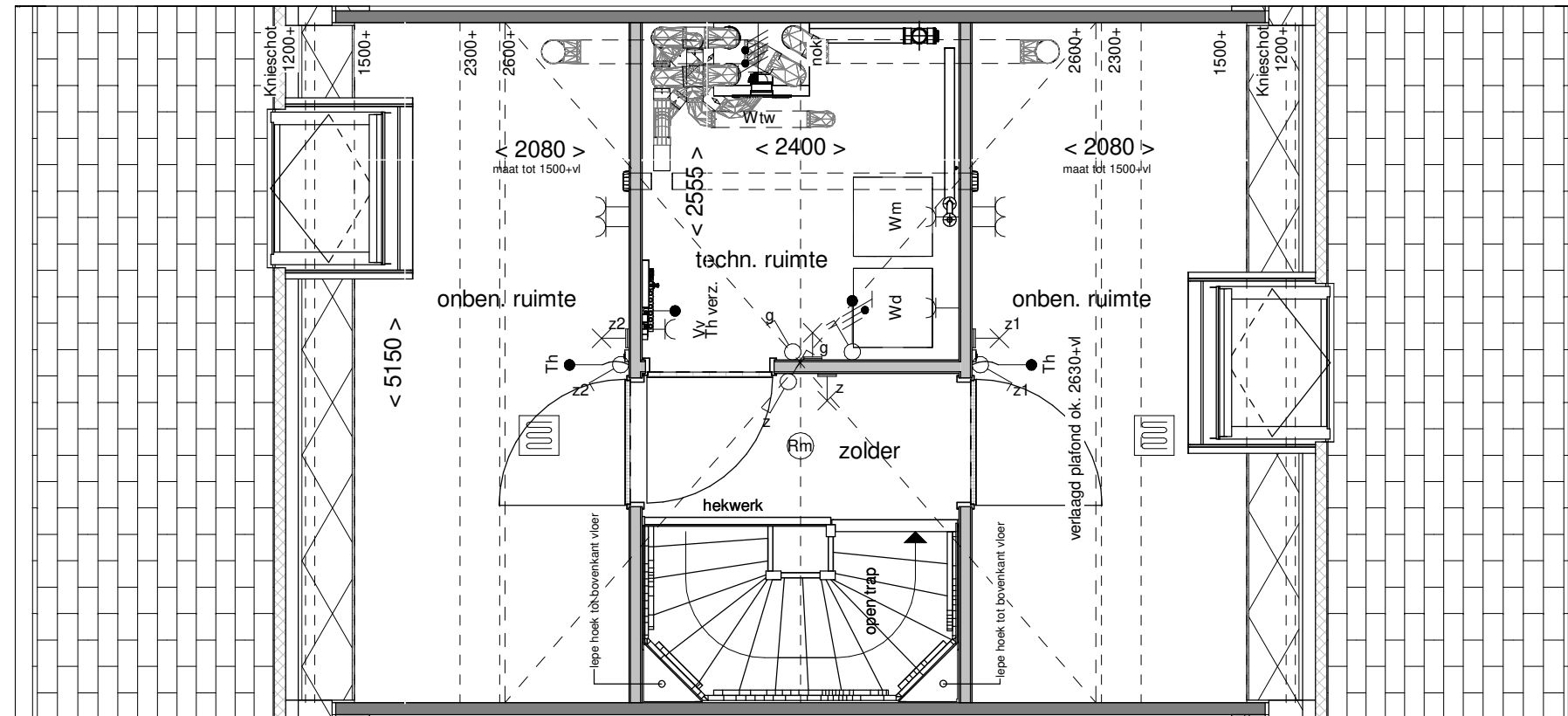

**ALLEMAAL
VIELEYAAL**

Optie: Indeling techn.- en 2
onb. ruimtes

Woningtype: X54

Bouwnummer: -

Optienummer: 1.C.X.76

Schaal: 1:50

Datum: 30-01-2024