

















**ALLEMAAL
YIELEYAAL**

Tekening: Situatie Fase 5-6
 Woningtype: _____
 Bouwnummer: _____
 Bladnummer: VT-S-01
 Schaal: 1:1000
 Datum: 17-06-2024



Renvooi

-  - entree woning
-  - parkeervak eigen terrein
-  - erfgrens
-  - struik type n.t.b. koper
-  - opstelplaats kliko
-  - tuinhekje
-  - klinkerbestrating
-  - betontegels 300x300mm
-  - groen strook
-  - haag h=900mm
-  - haag h=1800mm
-  - bamboehek h=1800mm
-  - gaashek met klimplanten en poort h=1600mm
-  - klimplant
-  - Slagboom met kast type ntb
-  - Straatverlichting

parkeerplekken en posities bomen, struiken en straatverlichting zijn indicatief

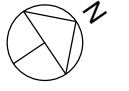











**ALLEMAAL
YIELEYAAL**

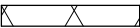

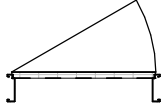
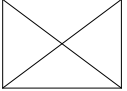



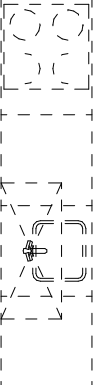





















Tekening: Situatie Blok J3
 Woningtype: Z45, YU
 Bouwnummer: 209-218
 Bladnummer: VT-S-14
 Schaal: 1:200
 Datum: 17-06-2024

Slagboom met kast type ntb;
 aangesloten op elektra/data
 in mantelbuis hoekwoning

Renvooi bouwkundig

	metselwerk kleur A
	dakpannen kleur oranje
	entree woning
	metselwerk
	isolatie
	dragende wand
	niet dragende binnenwand
	binnendeurkozijn (met bovenlicht)
	kruipluik
	opstelplaats wasmachine
	opstelplaats wasdroger
	
	principe opstelling keukenblok

Renvooi installaties

	aansluitpunt licht
	aansluitpunt licht, wand
	centraaldoos met lichtpunt
	armatuur aan de wand
	rookmelder
	aansluitpunt niet bedraad
	verdeelinrichting / meterkast / groepenkast
	beldrukker
	schel
	schakelaar, 1-polig
	werkschakelaar tbv PV-panelen
	schakelaar, 3-polig
	schakelaar, wissel
	schakelaar, kruis
	schakelaar, serie
	wandcontactdoos 1-voudig met beschermingscontact
	wandcontactdoos 2-voudig met beschermingscontact, verticaal
	wandcontactdoos 2-voudig met beschermingscontact
	thermostaatleiding, bedraad
	mechanische ventilatie-unit incl. warmteterugwinunit
	warmtepomp
	inblaasventiel mechanische ventilatie
	uitblaasventiel mechanische ventilatie
	verdeler vloerverwarming
	Afleverzet stadswarmte
	ruimte voorzien van vloerverwarming
	elektrische radiator
	kanalen in het zicht

Disclaimer

De op deze tekeningen aangegeven maten zijn circa maten in millimeters en tussen de wanden / vloeren gemeten, waarbij geen rekening is gehouden met enige wandafwerking, plinten, aftimmering, ect. In verband met de nauwkeurige uitwerking van details, constructie, maatvoering, materialen e.d. kunnen er kleine afwijkingen ontstaan ten opzichte van de nu vermelde gegevens. Deze geringe afwijkingen geven geen aanleiding tot verrekening. Aan de op deze tekening aangegeven maten kunnen derhalve geen rechten worden ontleend. De op deze tekeningen aangegeven maatvoering is niet geschikt voor opdrachten aan derden door koper(s). De posities van aansluitingen en installatie onderdelen zijn indicatief op tekening aangegeven. De exacte aantallen en posities zullen na berekening in het werk door de installateurs worden bepaald en kunnen afwijken van deze tekening.

**ALLEMAAL
YIELEYAAL**

Tekening: Renvooi

Woningtype: -

Bouwnummer: -

Bladnummer: VT-0-00c

Schaal: -

Datum: 19-10-2023



Type: Z45
Bouwnummer: 218

Type: Z45
Bouwnummer: 217

Type: Z45
Bouwnummer: 216

Type: Z45
Bouwnummer: 215

Type: Z45
Bouwnummer: 214

Type: Z45
Bouwnummer: 213

Type: Z45
Bouwnummer: 212

Type: Z45
Bouwnummer: 211

Type: Z45
Bouwnummer: 210

Type: YU
Bouwnummer: 209

Voorgevel



Type: YU
Bouwnummer: 209

Type: Z45
Bouwnummer: 210

Type: Z45
Bouwnummer: 211

Type: Z45
Bouwnummer: 212

Type: Z45
Bouwnummer: 213

Type: Z45
Bouwnummer: 214

Type: Z45
Bouwnummer: 215

Type: Z45
Bouwnummer: 216

Type: Z45
Bouwnummer: 217

Type: Z45
Bouwnummer: 218

Achtergevel

**ALLEMAAL
YIELEYAAL**

Tekening: Gevels blok J3

Woningtype: Z45, YU

Bouwnummer: 209 t/m 218

Bladnummer: VT-J3-00a

Schaal: 1:150

Datum: 30-01-2024



Type: Z45
Bouwnummer: 218

Linker zijgevel



Type: YU
Bouwnummer: 209

Rechter zijgevel

**ALLEMAAL
YIELEYAAL**

Tekening: Zijgevels blok J3

Woningtype: Z45, YU

Bouwnummer: 209 t/m 218

Bladnummer: VT-J3-00b

Schaal: 1:100

Datum: 30-01-2024



Doorsnede A

Type: Z45
Bouwnummer: 218

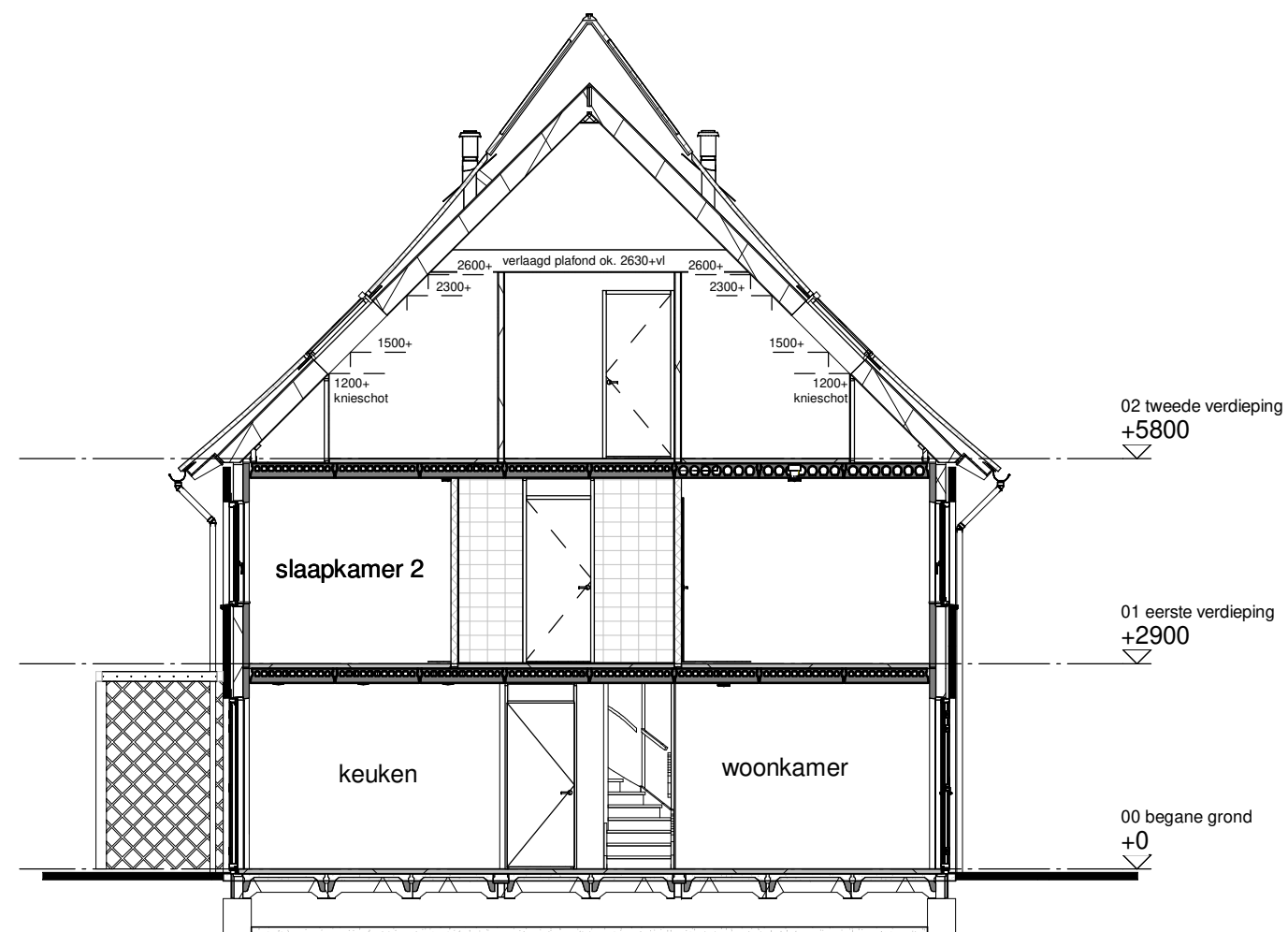

Doorsnede B

Type: YU
Bouwnummer: 209

**ALLEMAAL
YIELEYAAL**

Tekening: Doorsnedes blok J3

Woningtype: Z45, YU

Bouwnummer: 209 t/m 218

Bladnummer: VT-J3-00c

Schaal: 1:100

Datum: 30-01-2024

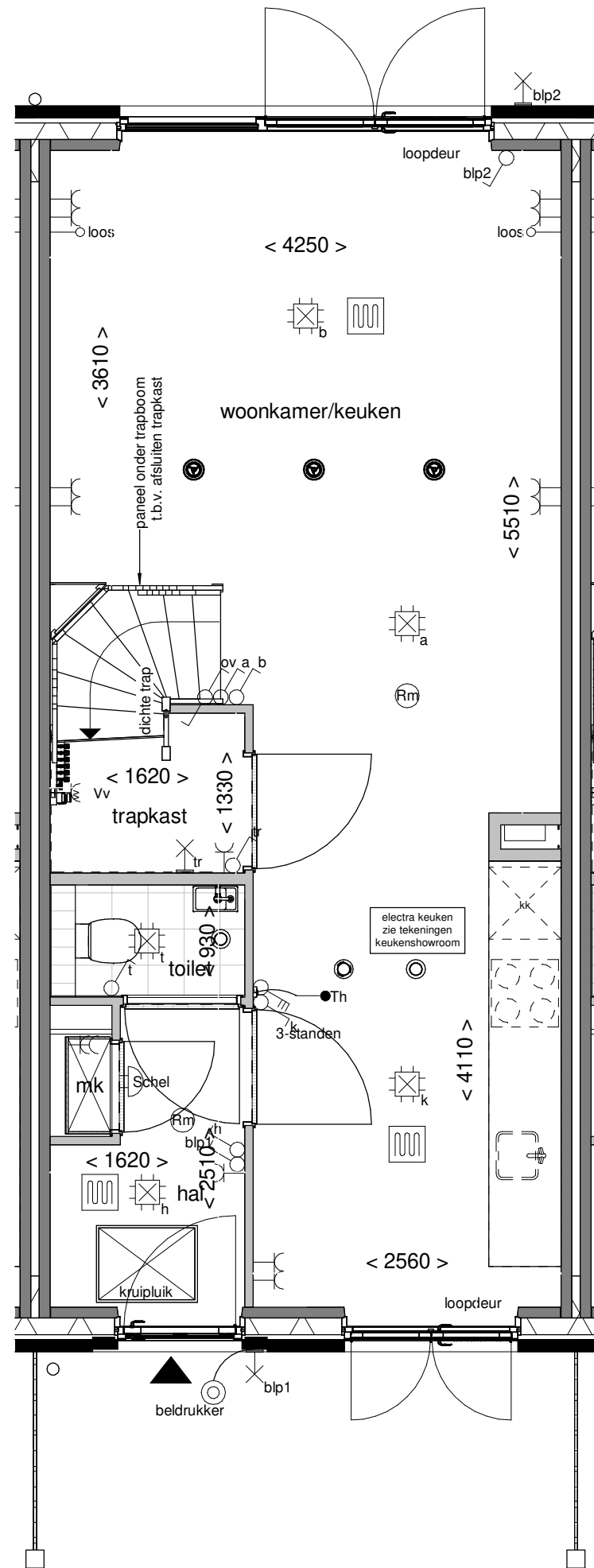

**ALLEMAAL
YIELEYAAL**

Tekening: Begane grond
 Woningtype: Z45
 Bouwnummer: 215
 Bladnummer: VT-J3-215a
 Schaal: 1:50
 Datum: 30-01-2024

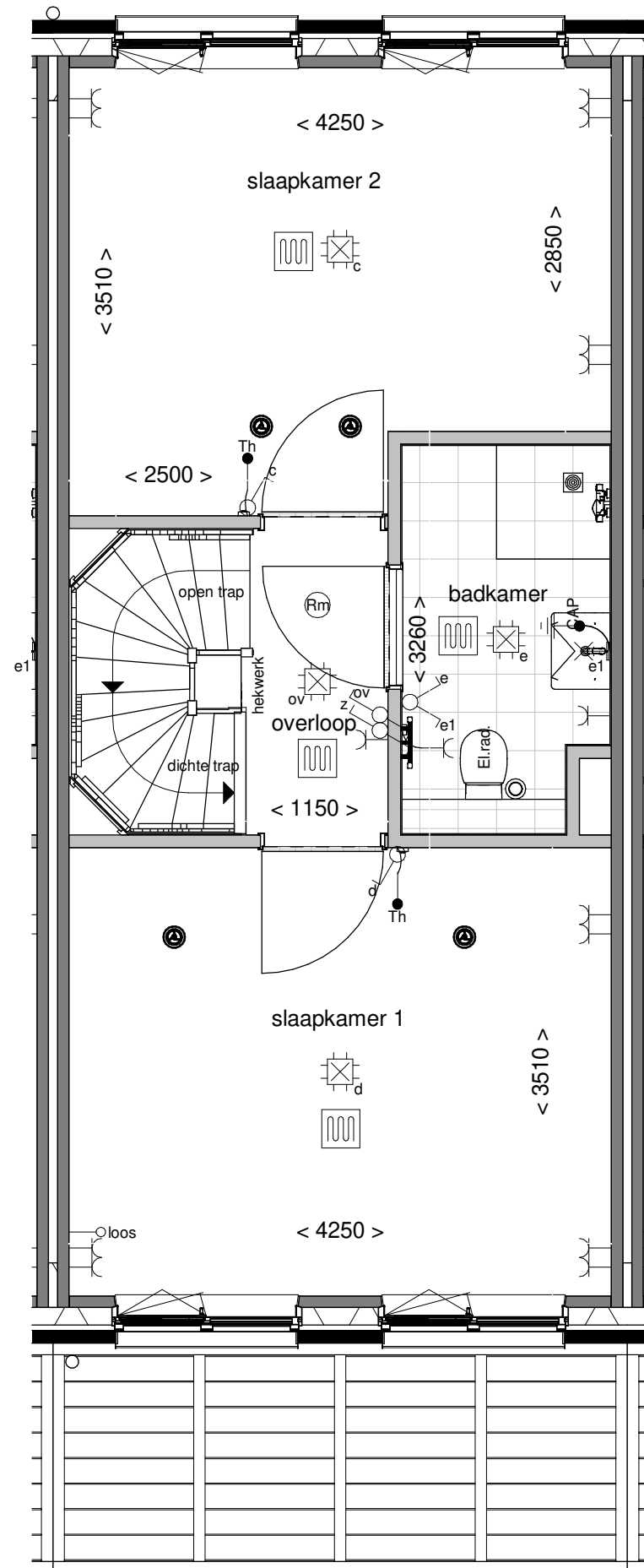

**ALLEMAAL
YIELEYAAL**

Tekening: Eerste verdieping

Woningtype: Z45

Bouwnummer: 215

Bladnummer: VT-J3-215b

Schaal: 1:50

Datum: 30-01-2024

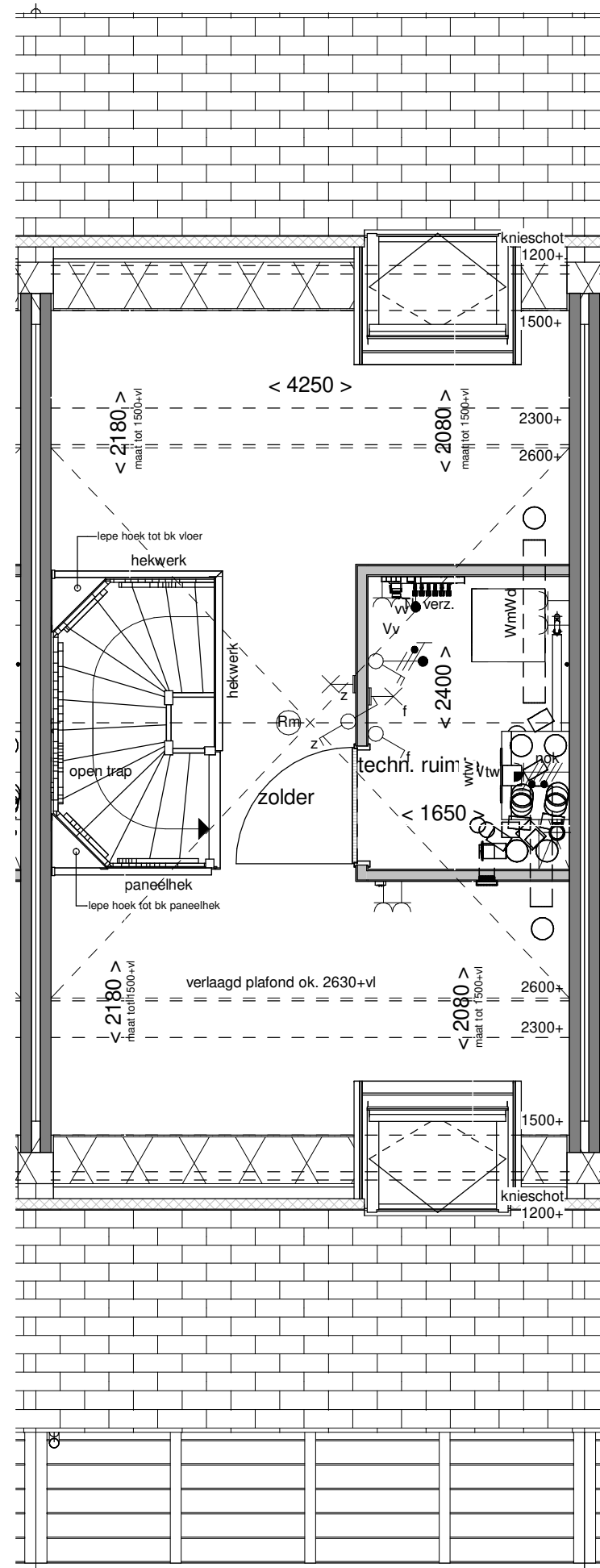

**ALLEMAAL
YIELEYAAL**

Tekening: Tweede verdieping

Woningtype: Z45

Bouwnummer: 215

Bladnummer: VT-J3-215c

Schaal: 1:50

Datum: 30-01-2024

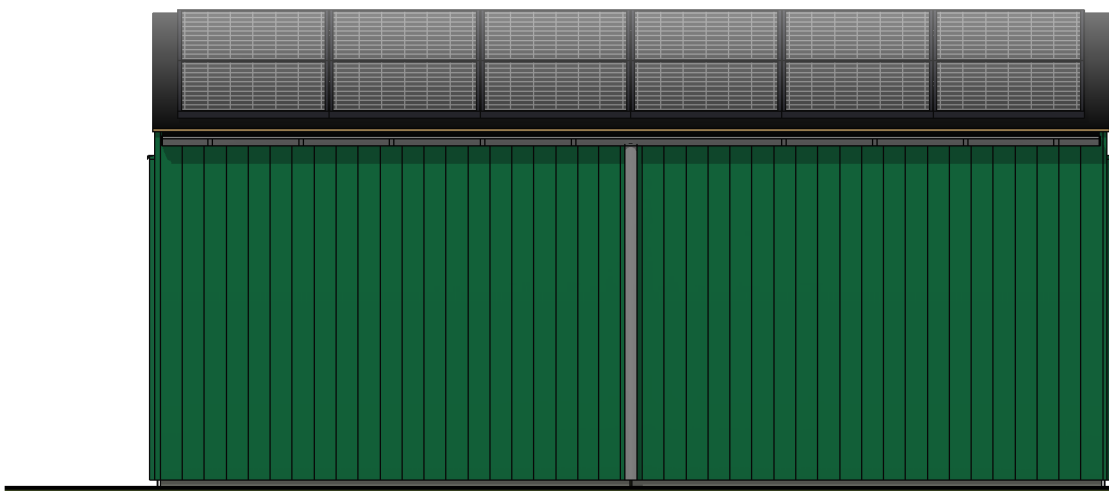

Voorgevel

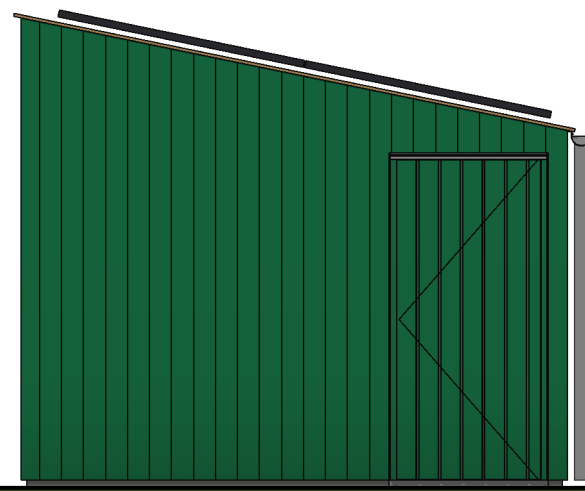

Linker zijgevel

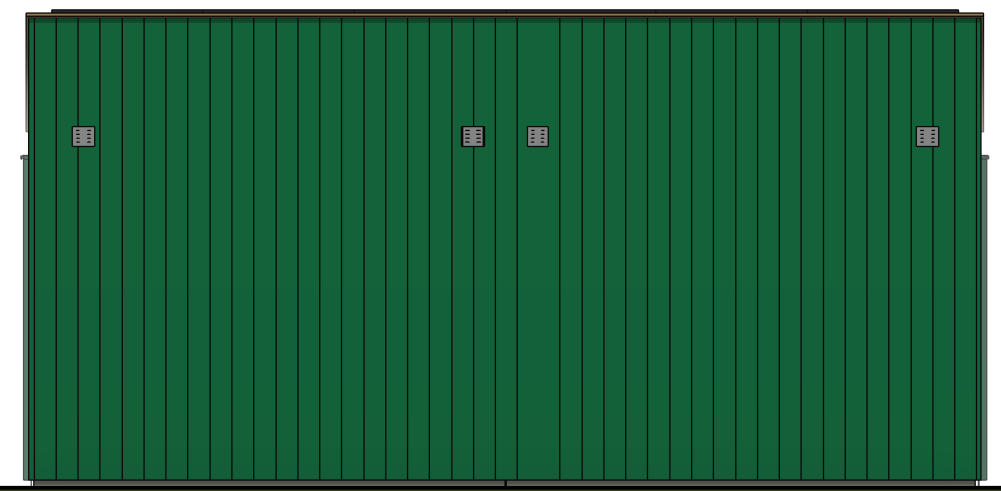

Achtergevel

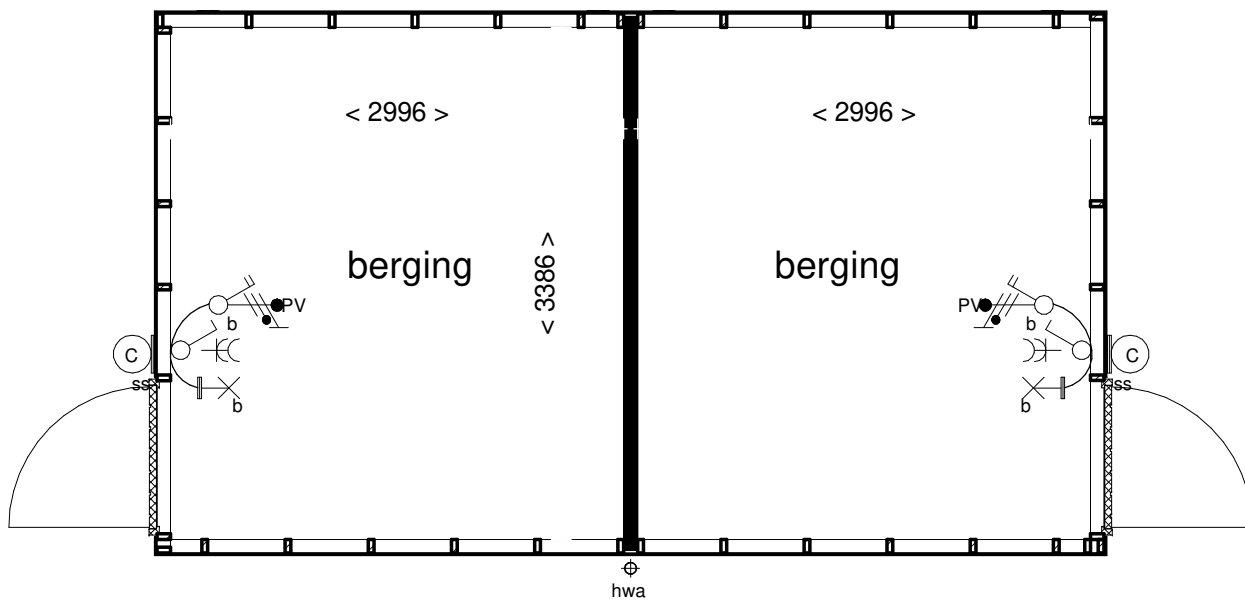

Begane grond

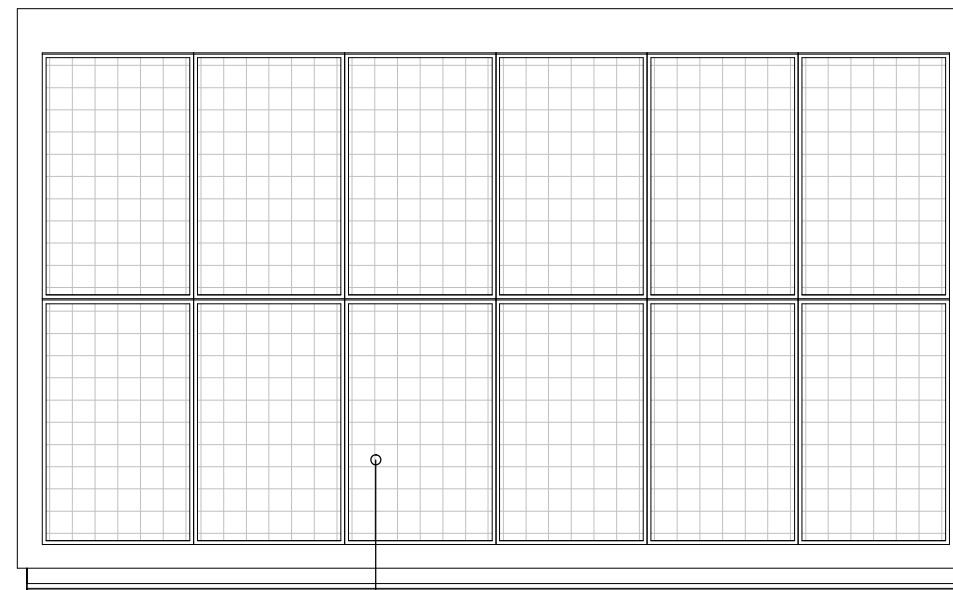

Dakaanzicht

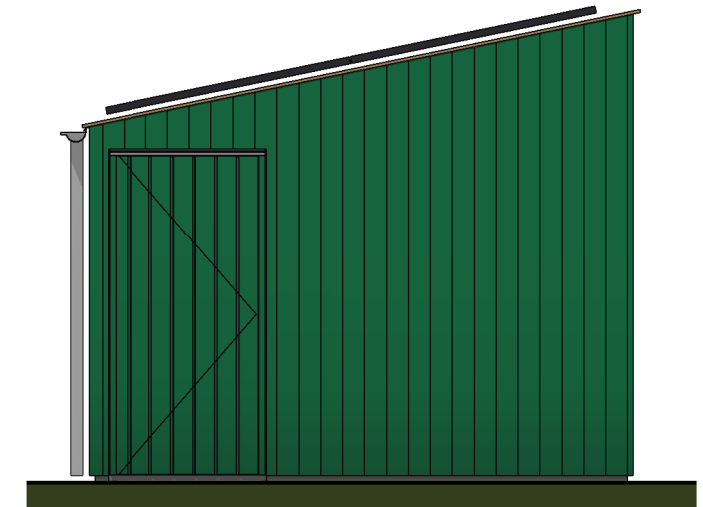

Rechter zijgevel

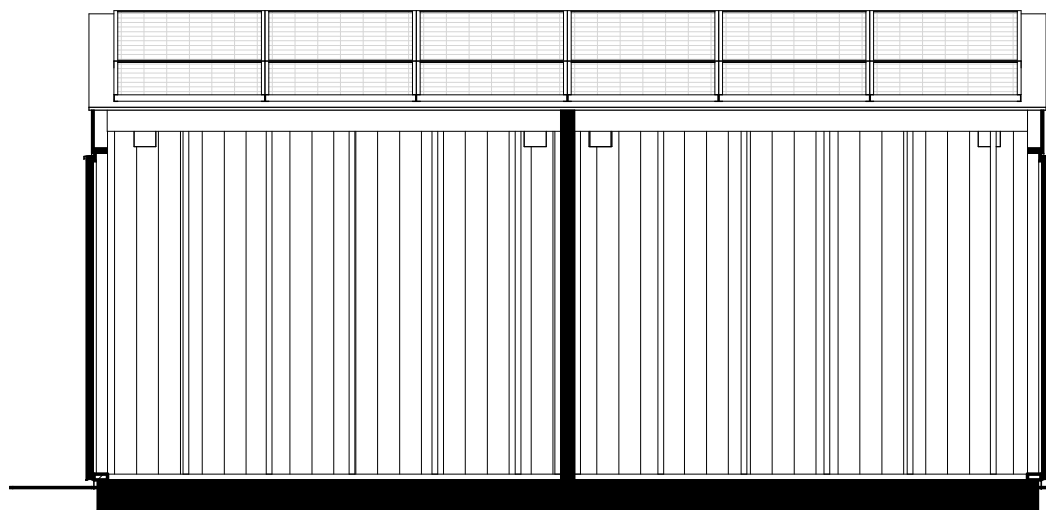

Doorsnede A-A

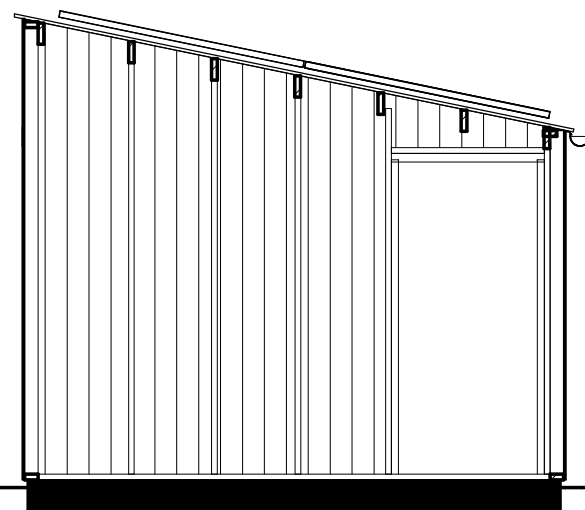

Doorsnede B-B



3D aanzicht

**ALLEMAAL
YIELEYAAL**

Tekening: **Berging B2**

Woningtype: -

Bouwnummer: 209-210,211-212,213-214,215-216,217-218
219-220,221-22,223-224,225-226,227-228
229-230

Bladnummer: **VT-BE03**

Schaal: **1:50**

Datum: **30-01-2024**

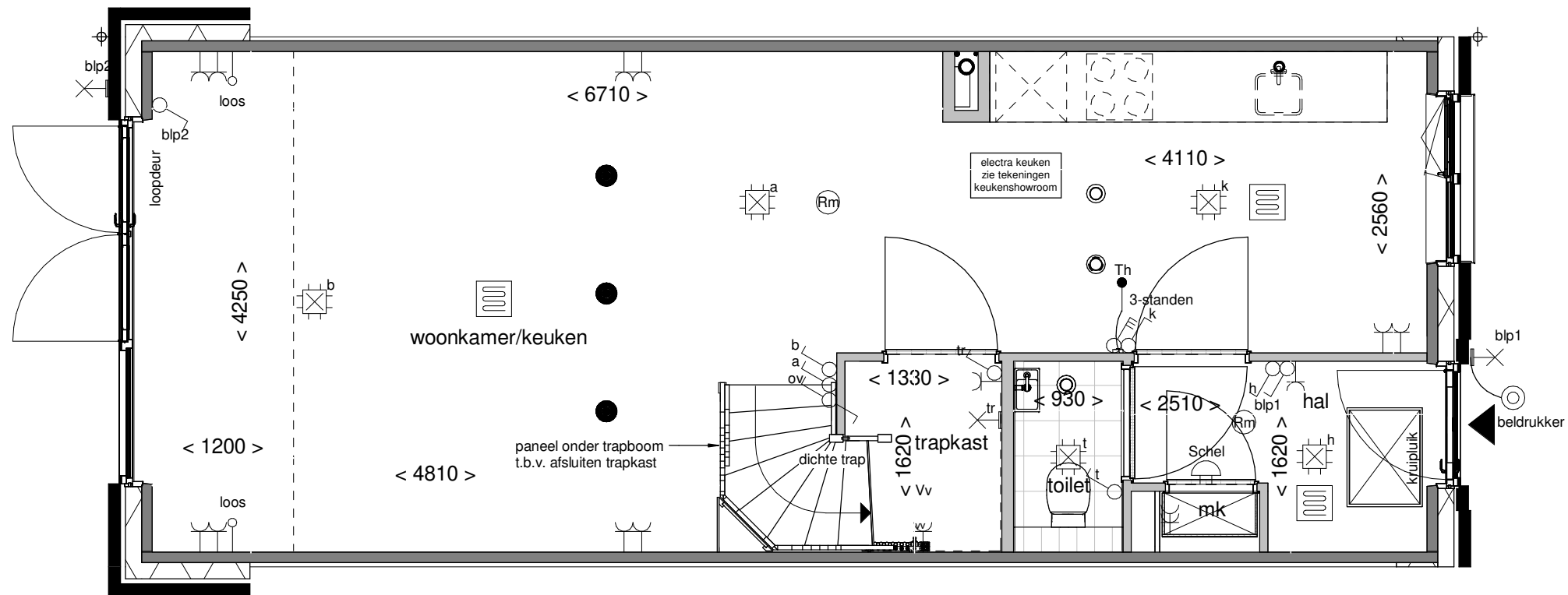

Achtergevel schaal 1:100

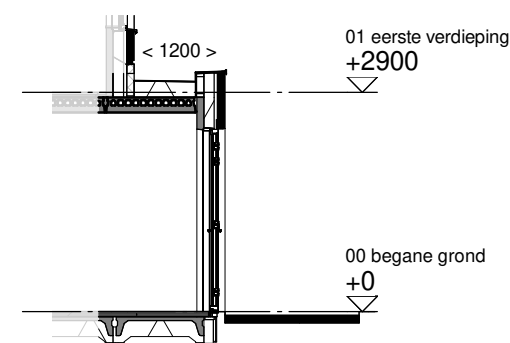

Doorsnede schaal 1:100

**ALLEMAAL
VIELEYAAL**

Optie: **Uitbouw achtergevel
1200mm**

Woningtype: **Z45**

Bouwnummer: **-**

Optienummer: **0.A.Z.14**

Schaal: **1:50 / 1:100**

Datum: **30-01-2024**

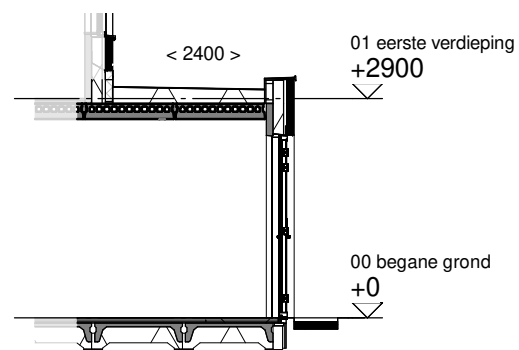
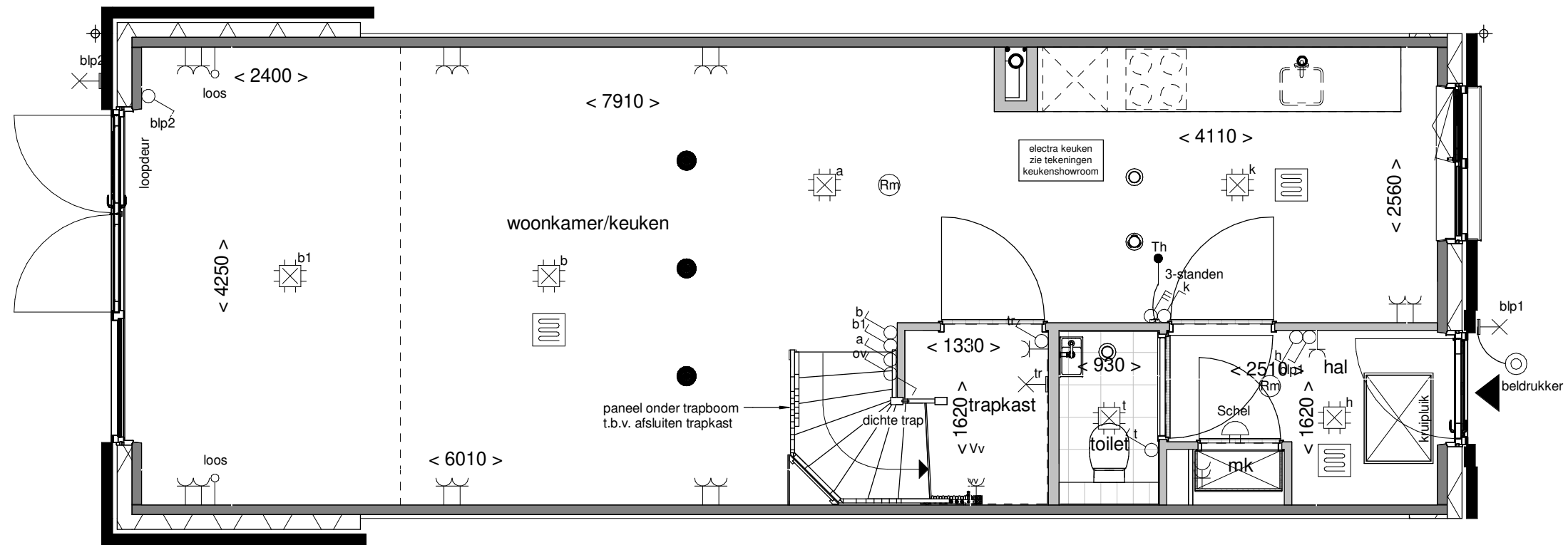

Doorsnede schaal 1:100



Achtergevel schaal 1:100

**ALLEMAAL
VIELEYAAL**

Optie: **Uitbouw achtergevel
2400mm**

Woningtype: **Z45**

Bouwnummer: -

Optienummer: **0.A.Z.34**

Schaal: **1:50 / 1:100**

Datum: **30-01-2024**

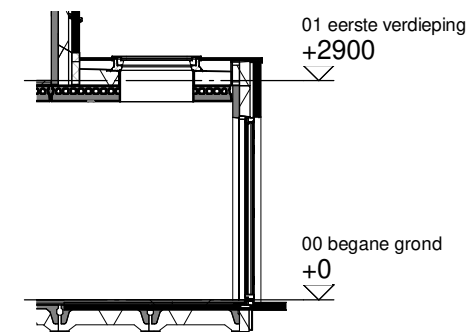
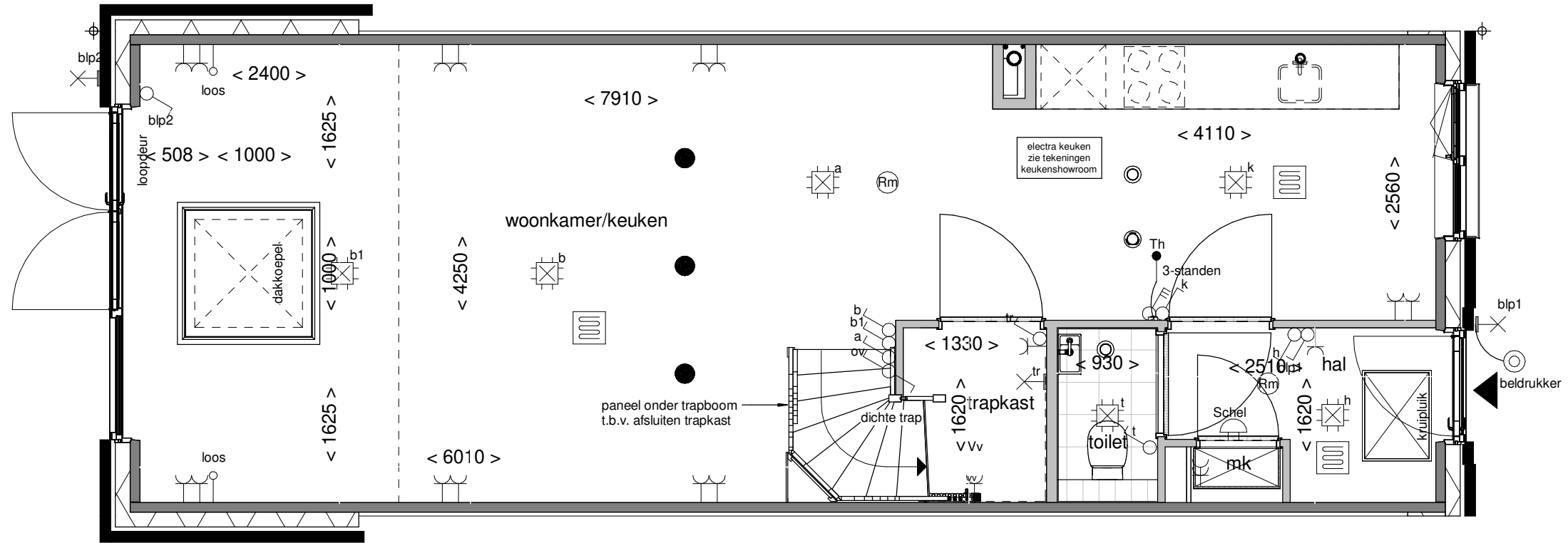

Doorsnede schaal 1:100

**ALLEMAAL
VIELEYAAL**

Optie: Lichtkoepel in
uitbouw 2400mm

Woningtype: Z45

Bouwnummer: -

Optienummer: 1.B.X.10

Schaal: 1:50 / 1:100

Datum: 30-01-2024

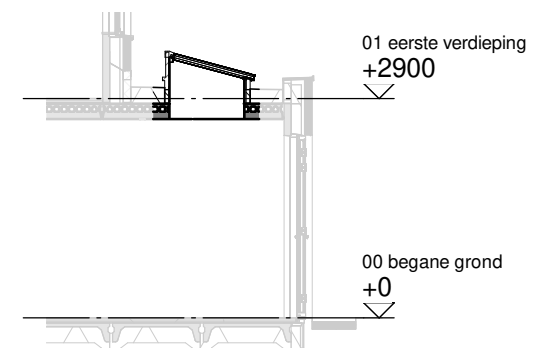
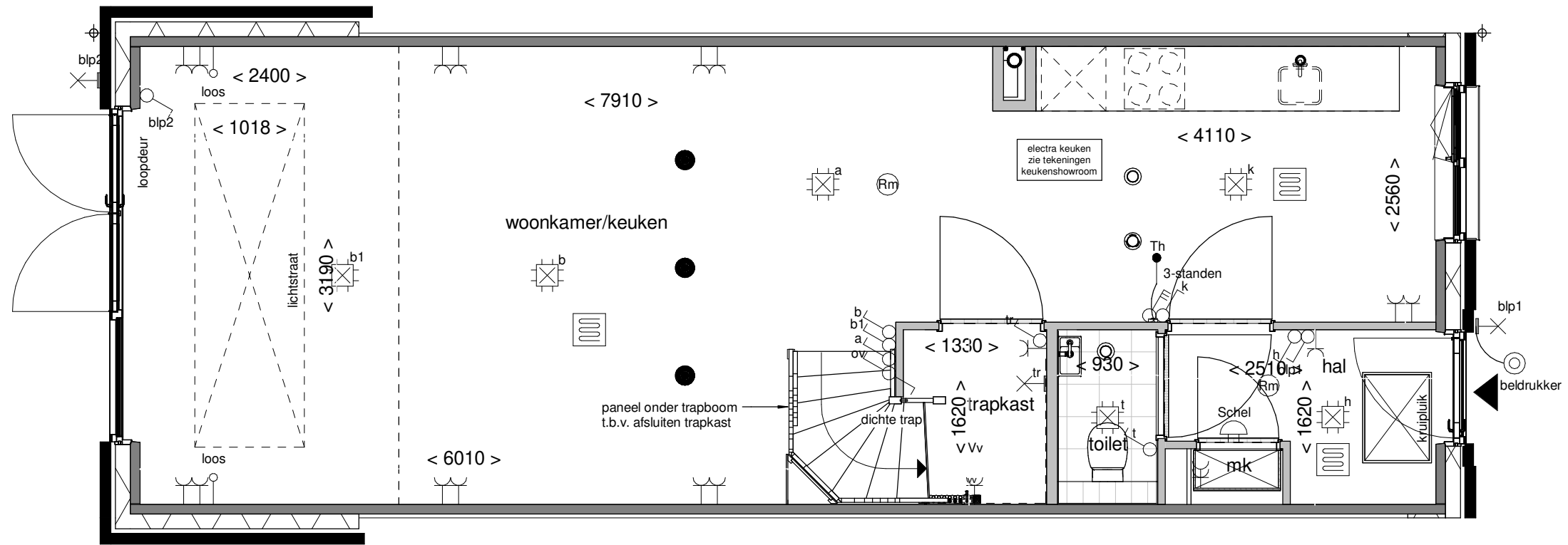

Doorsnede schaal 1:100

**ALLEMAAL
VIELEYAAL**

Optie: Lichtstraat in uitbouw
2400mm

Woningtype: Z45

Bouwnummer: -

Optienummer: 1.B.X.14

Schaal: 1:50 / 1:100

Datum: 30-01-2024

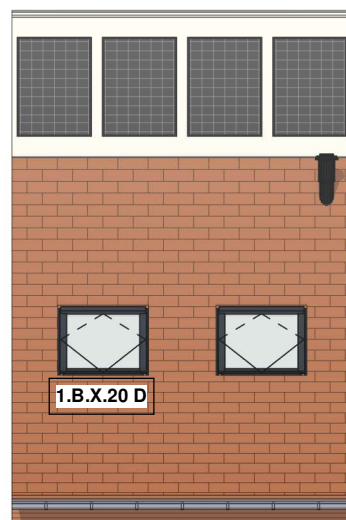
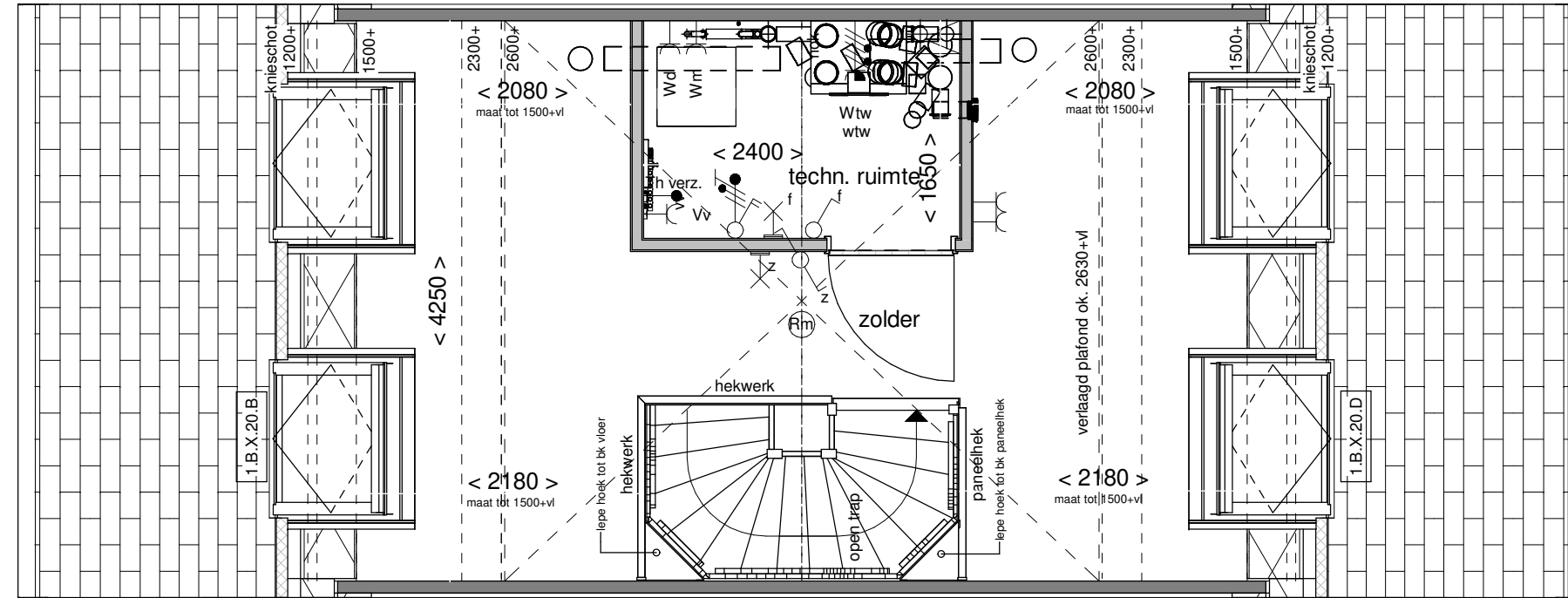

Voorgevel schaal 1:100

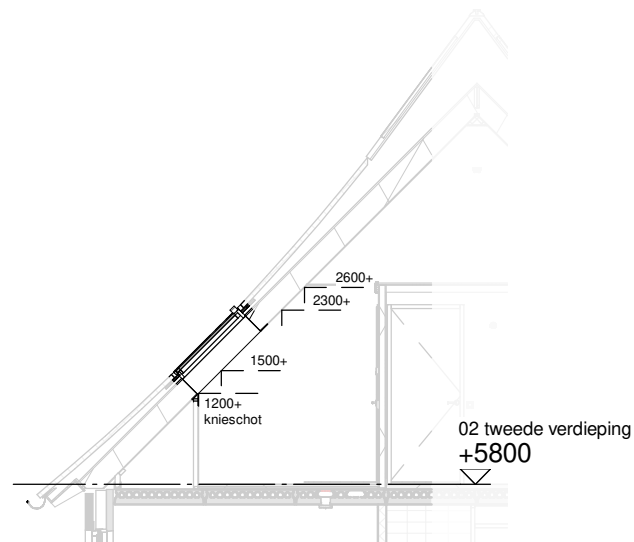

Doorsnede schaal 1:100

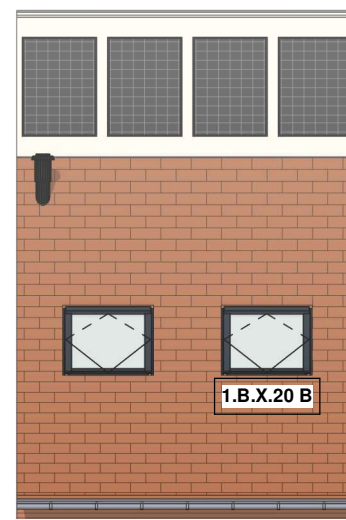

Achtergevel schaal 1:100

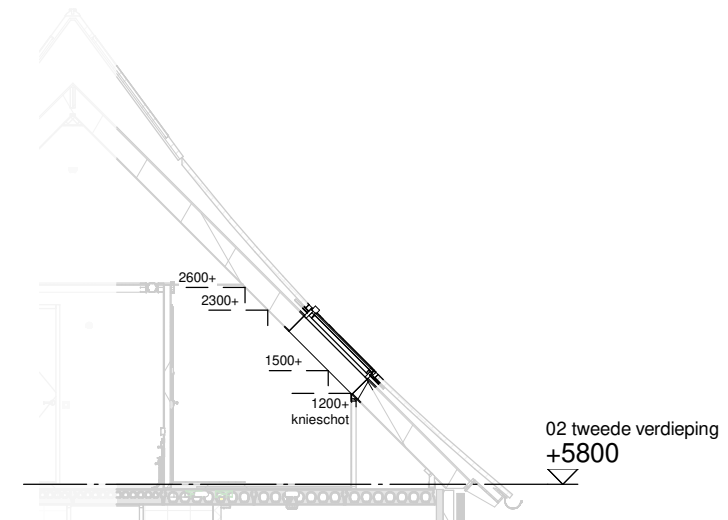

Doorsnede schaal 1:100

**ALLEMAAL
VIELEYAAL**

Optie: Dakramen voor- en achtergevel

Woningtype: Z45

Bouwnummer: -

Optienummer: 1.B.X.20

Schaal: 1:50 / 1:100

Datum: 30-01-2024

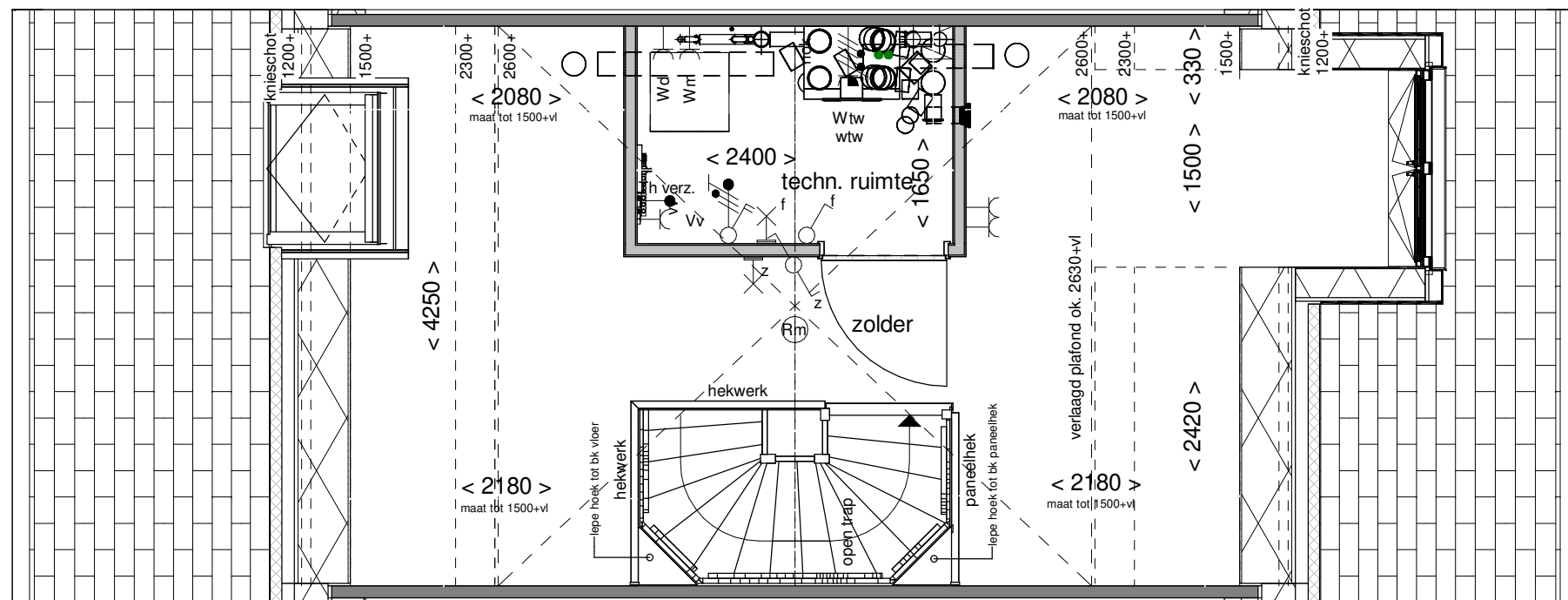

Voorgevel schaal 1:100

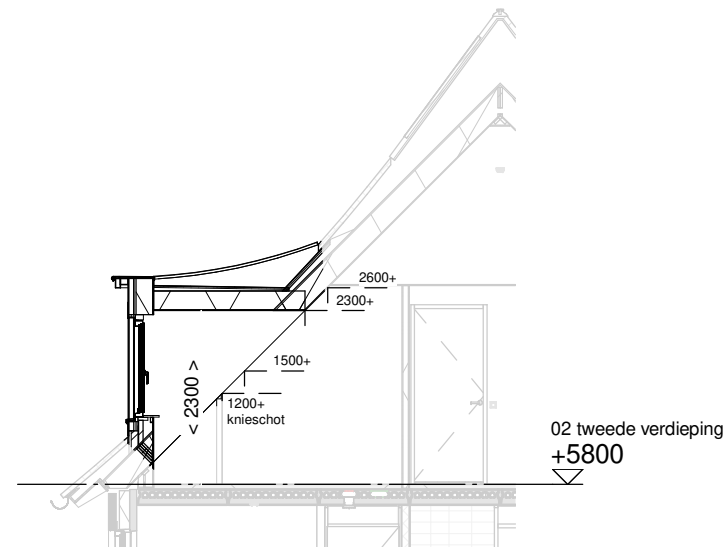

Doorsnede schaal 1:100

**ALLEMAAL
VIELEYAAL**

Optie: Dakkapel
voorgevel 1500mm

Woningtype: Z45

Bouwnummer: -

Optienummer: 1.B.X.33

Schaal: 1:50 / 1:100

Datum: 30-01-2024

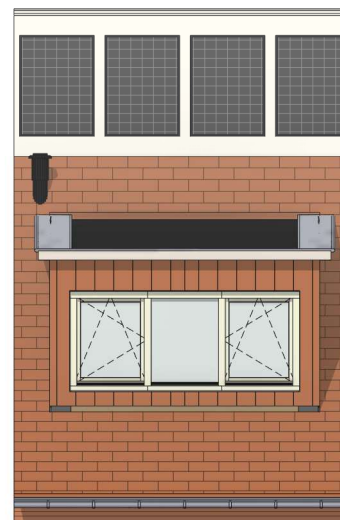
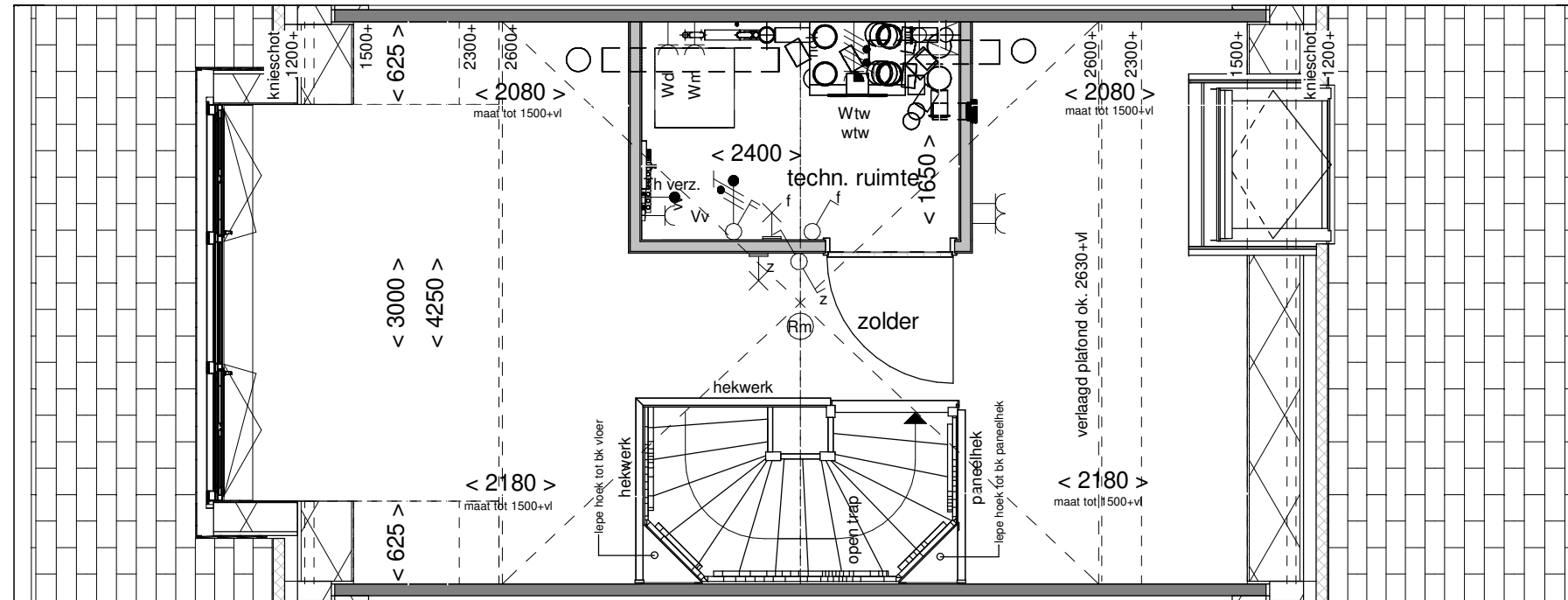

Achtergevel schaal 1:100

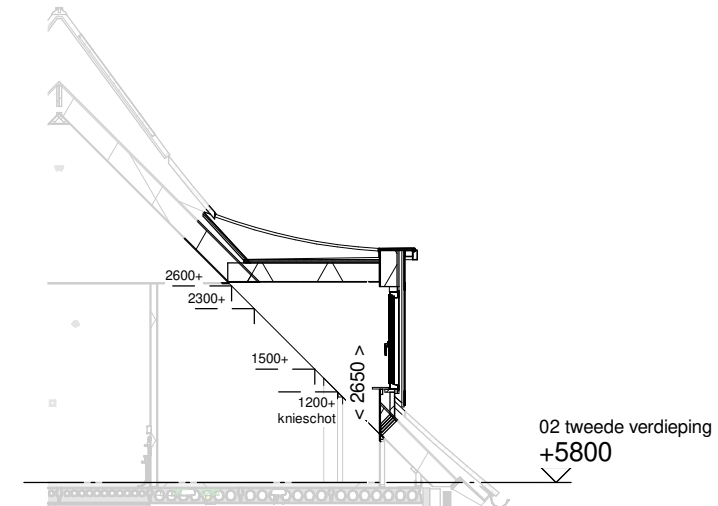

Achtergevel schaal 1:100

**ALLEMAAL
YIELEYAAL**

Optie: Dakkapel
achtergevel 3000mm

Woningtype: Z45

Bouwnummer: -

Optienummer: 1.B.X.34

Schaal: 1:50 / 1:100

Datum: 30-01-2024

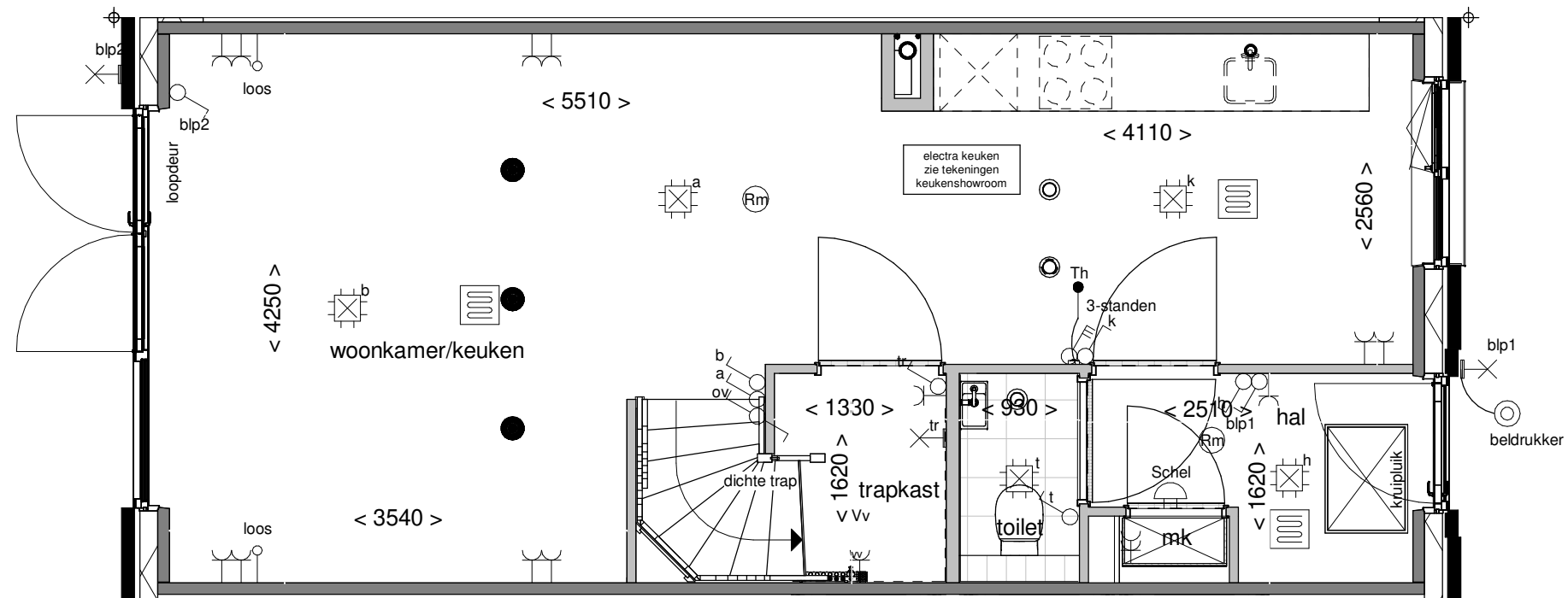

**ALLEMAAL
YIELEYAAL**

Optie: Wand naast trap

Woningtype: Z45

Bouwnummer: -

Optienummer: 1.C.Z.10

Schaal: 1:50

Datum: 30-01-2024

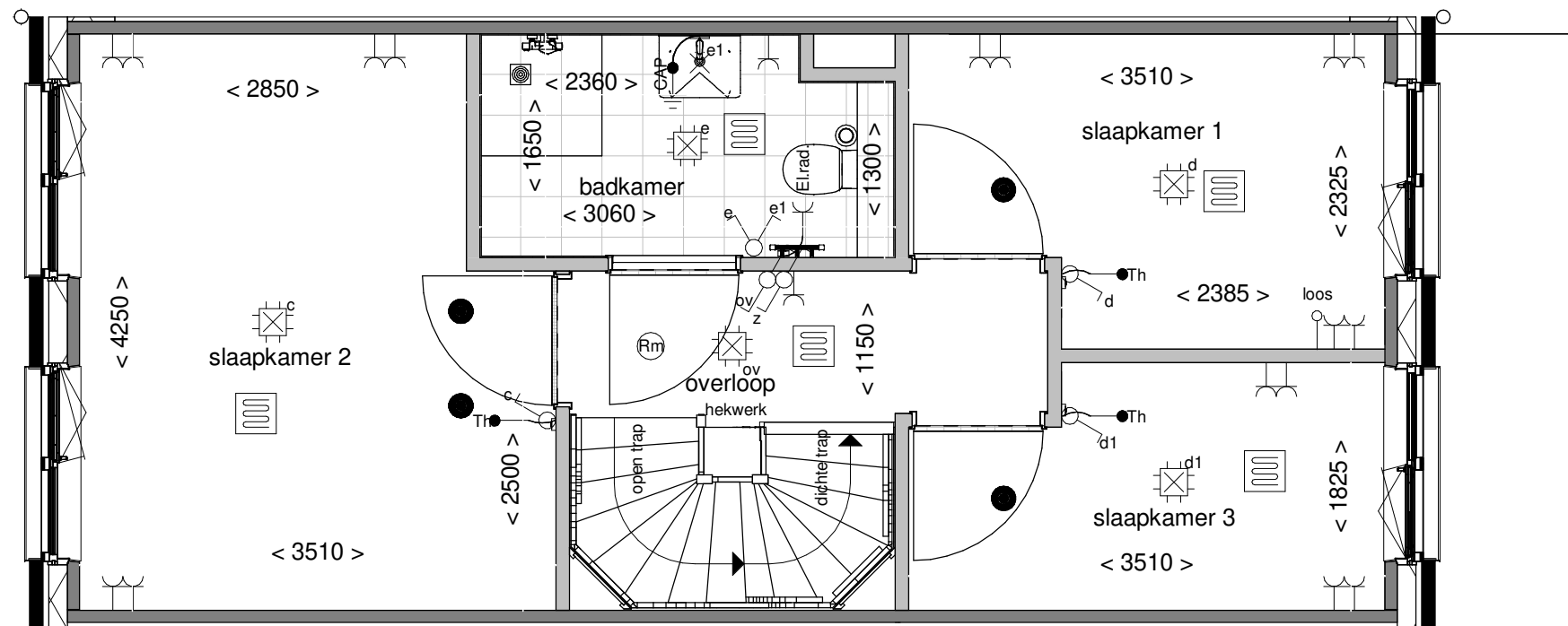

**ALLEMAAL
VIELEYAAL**

Optie: Twee slaapkamers
voorzijde

Woningtype: Z45

Bouwnummer: -

Optienummer: 1.C.Z.36

Schaal: 1:50

Datum: 30-01-2024

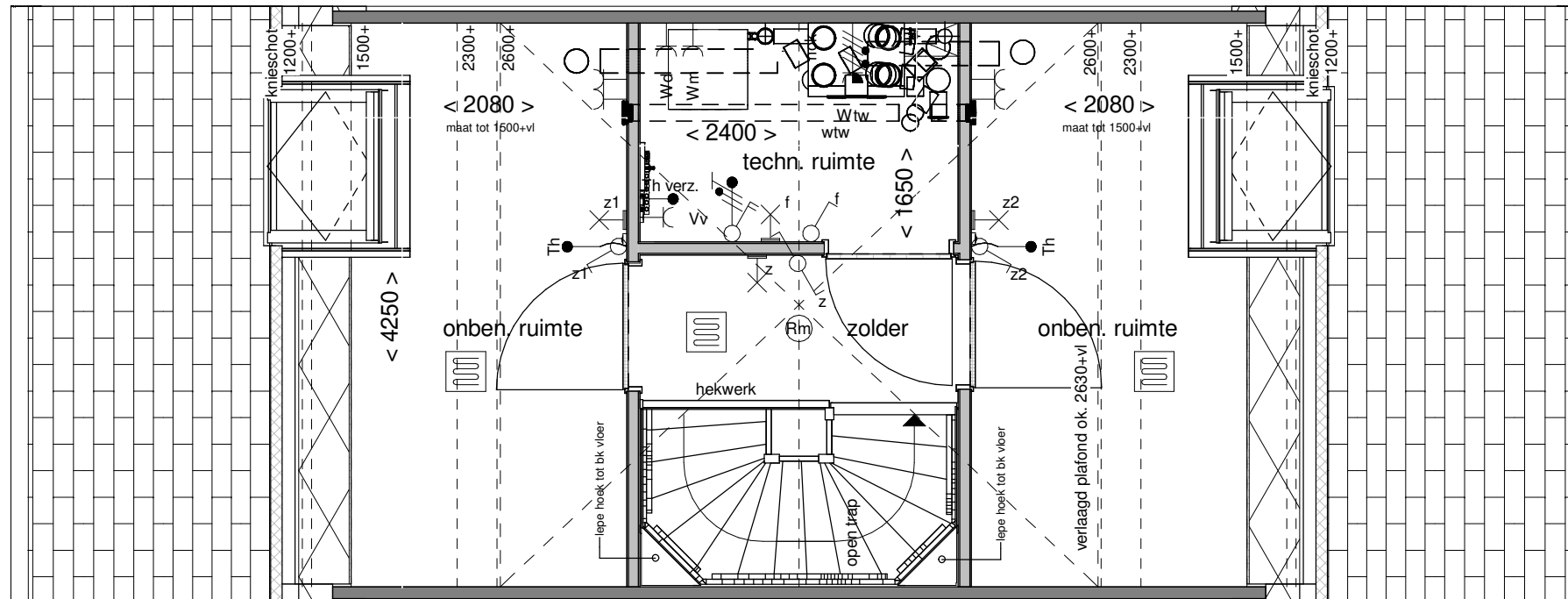

**ALLEMAAL
VIELEYAAL**

Optie: Indeling techn.- en
2 onb. ruimtes

Woningtype: Z45

Bouwnummer: -

Optienummer: 1.C.Z.76

Schaal: 1:50

Datum: 30-01-2024