

**ALLEMAAL  
YIELEYAAL**

Tekening: Situatie Fase 5-6  
 Woningtype: \_\_\_\_\_  
 Bouwnummer: \_\_\_\_\_  
 Bladnummer: VT-S-01  
 Schaal: 1:1000  
 Datum: 30-01-2024

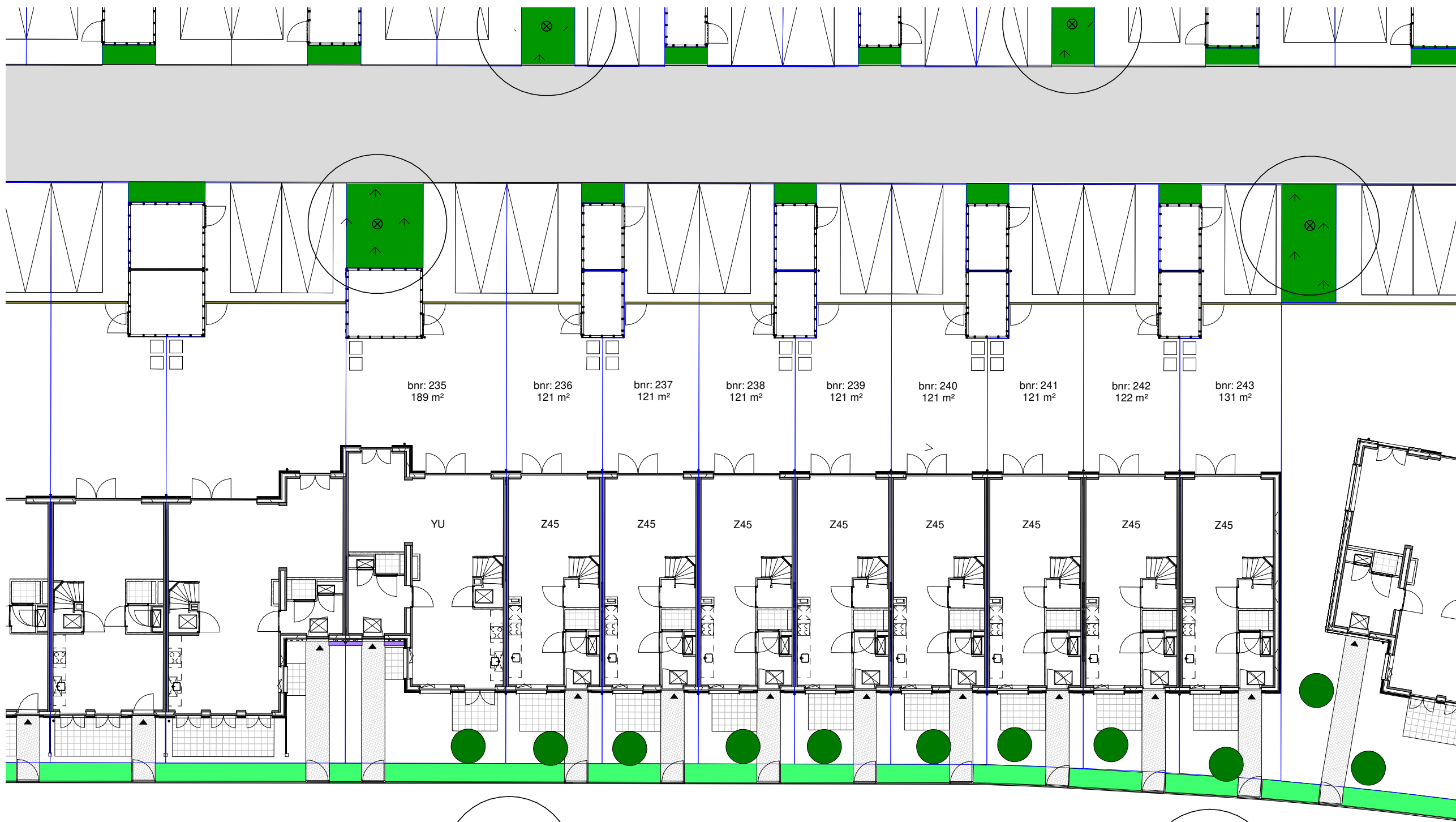

**Renvooi**

- entree woning
- parkeervak eigen terrein
- erfgrans
- beplanting type n.t.b. koper
- opstelplaats kliko
- tuinhekje
- klinkerbestrating
- betontegels 300x300mm
- groen strook
- haag h=900mm
- haag h=1800mm
- bamboehok h=1800mm
- gaashek met klimplanten en poort h=1600mm
- klimplant

parkeerplekken en posities bomen en struiken zijn indicatief













Rollostraat

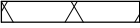

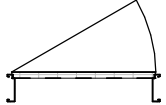
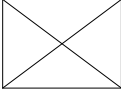



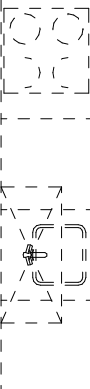





















**ALLEMAAL  
YIELEYAAL**

Tekening: Situatie Blok K2  
 Woningtype: YU, Z45  
 Bouwnummer: 235-243  
 Bladnummer: VT-S-10  
 Schaal: 1:200  
 Datum: 30-01-2024

## Renvooi bouwkundig

	metselwerk kleur A
	dakpannen kleur oranje
	entree woning
	metselwerk
	isolatie
	dragende wand
	niet dragende binnenwand
	binnendeurkozijn (met bovenlicht)
	kruipluik
	opstelplaats wasmachine
	opstelplaats wasdroger
	
	principe opstelling keukenblok

## Renvooi installaties

	aansluitpunt licht
	aansluitpunt licht, wand
	centraaldoos met lichtpunt
	armatuur aan de wand
	rookmelder
	aansluitpunt niet bedraad
	verdeelinrichting / meterkast / groepenkast
	beldrukker
	schel
	schakelaar, 1-polig
	werkschakelaar tbv PV-panelen
	schakelaar, 3-polig
	schakelaar, wissel
	schakelaar, kruis
	schakelaar, serie
	wandcontactdoos 1-voudig met beschermingscontact
	wandcontactdoos 2-voudig met beschermingscontact, verticaal
	wandcontactdoos 2-voudig met beschermingscontact
	thermostaatleiding, bedraad
	mechanische ventilatie-unit incl. warmteterugwinunit
	warmtepomp
	inblaasventiel mechanische ventilatie
	afzuigventiel mechanische ventilatie
	verdelers vloerverwarming
	Afleverzet stadswarmte
	ruimte voorzien van vloerverwarming
	elektrische radiator
	kanalen in het zicht

### Disclaimer

De op deze tekeningen aangegeven maten zijn circa maten in millimeters en tussen de wanden / vloeren gemeten, waarbij geen rekening is gehouden met enige wandafwerking, plinten, aftimmering, ect. In verband met de nauwkeurige uitwerking van details, constructie, maatvoering, materialen e.d. kunnen er kleine afwijkingen ontstaan ten opzichte van de nu vermelde gegevens. Deze geringe afwijkingen geven geen aanleiding tot verrekening. Aan de op deze tekening aangegeven maten kunnen derhalve geen rechten worden ontleend. De op deze tekeningen aangegeven maatvoering is niet geschikt voor opdrachten aan derden door koper(s). De posities van aansluitingen en installatie onderdelen zijn indicatief op tekening aangegeven. De exacte aantallen en posities zullen na berekening in het werk door de installateurs worden bepaald en kunnen afwijken van deze tekening.

**ALLEMAAL  
YIELEYAAL**

Tekening: Renvooi

Woningtype: -

Bouwnummer: -

Bladnummer: VT-0-00c

Schaal: -

Datum: 30-01-2024



Type: YU Bouwnummer: 235    Type: Z45 Bouwnummer: 236    Type: Z45 Bouwnummer: 237    Type: Z45 Bouwnummer: 238    Type: Z45 Bouwnummer: 239    Type: Z45 Bouwnummer: 240    Type: Z45 Bouwnummer: 241    Type: Z45 Bouwnummer: 242    Type: Z45 Bouwnummer: 243

Voorgevel



Type: Z45 Bouwnummer: 243    Type: Z45 Bouwnummer: 242    Type: Z45 Bouwnummer: 241    Type: Z45 Bouwnummer: 240    Type: Z45 Bouwnummer: 239    Type: Z45 Bouwnummer: 238    Type: Z45 Bouwnummer: 237    Type: Z45 Bouwnummer: 236    Type: YU Bouwnummer: 235

Achtergevel

ALLEMAAL  
YIELEYAAL

Tekening: Gevels blok K2

Woningtype: Z45, YU

Bouwnummer: 235 t/m 243

Bladnummer: VT-K2-00a

Schaal: 1:150

Datum: 30-01-2024



Type: YU  
bwnr: 235

Linker zijgevel

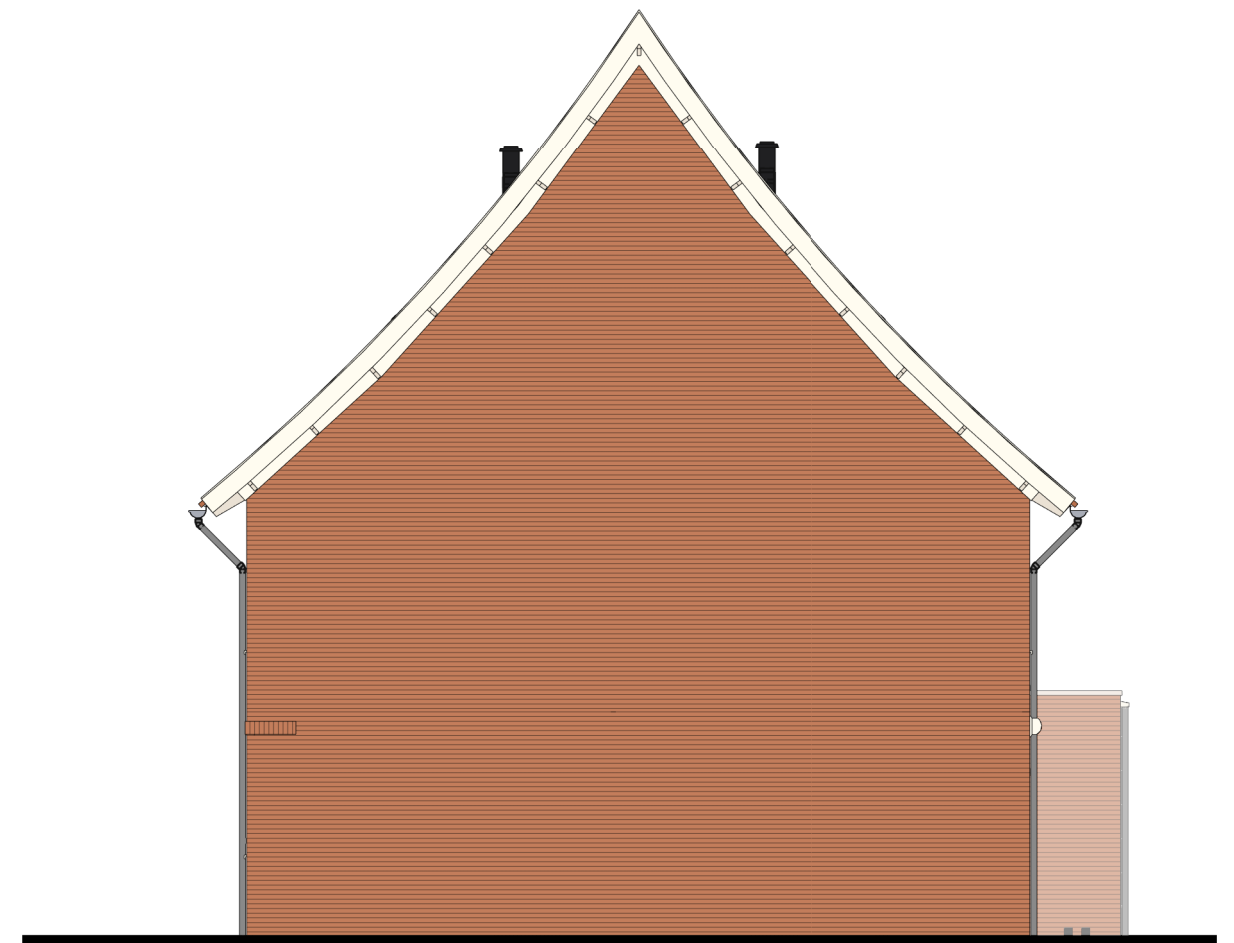

Type: Z45  
bwnr: 243

Rechter zijgevel

**ALLEMAAL  
YIELEYAAL**

Tekening: Zijgevels blok K2

Woningtype: Z45, YU

Bouwnummer: 235 t/m 243

Bladnummer: VT-K2-00b

Schaal: 1:100

Datum: 30-01-2024

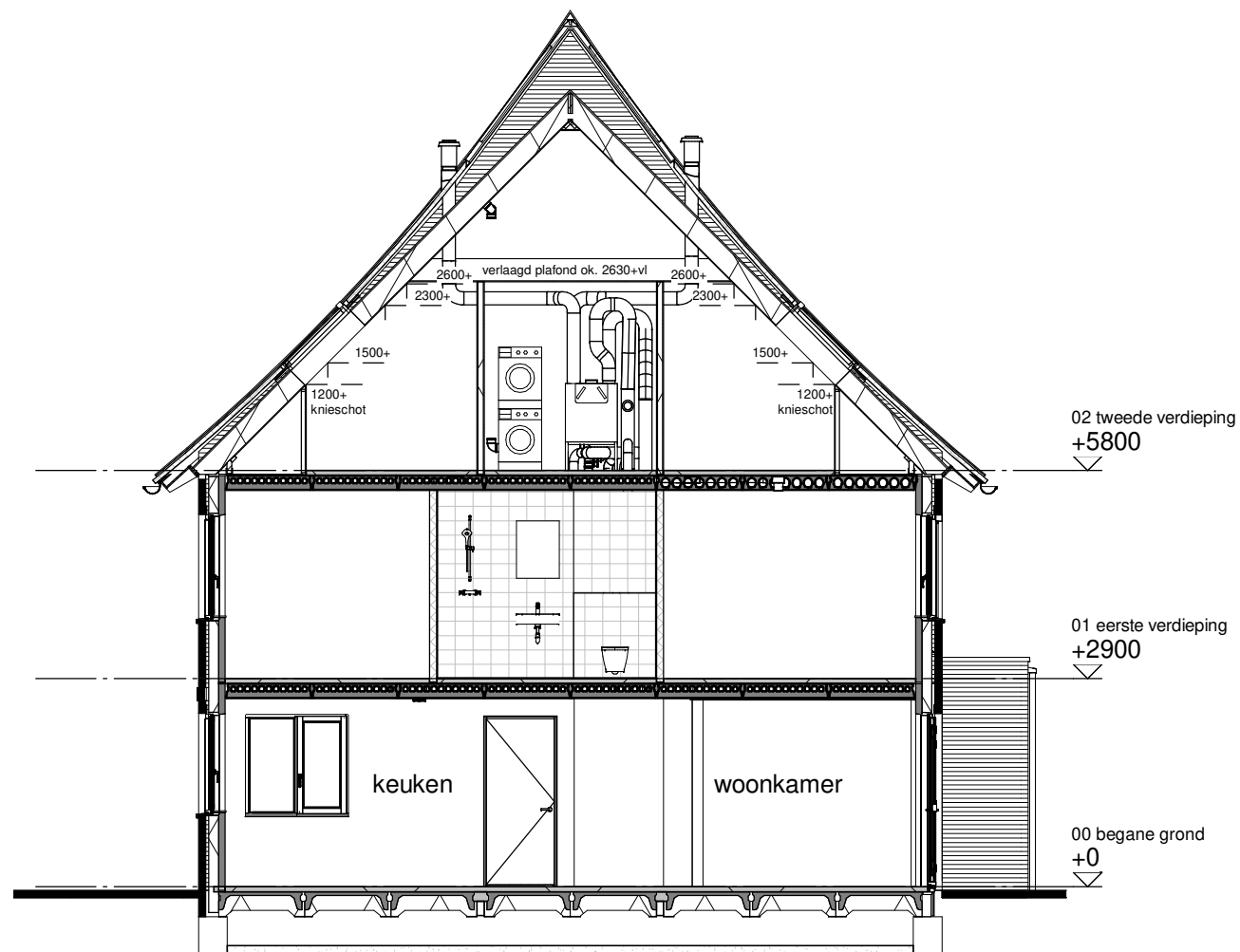

Type: YU  
Bouwnummer: 235

Doorsnede A

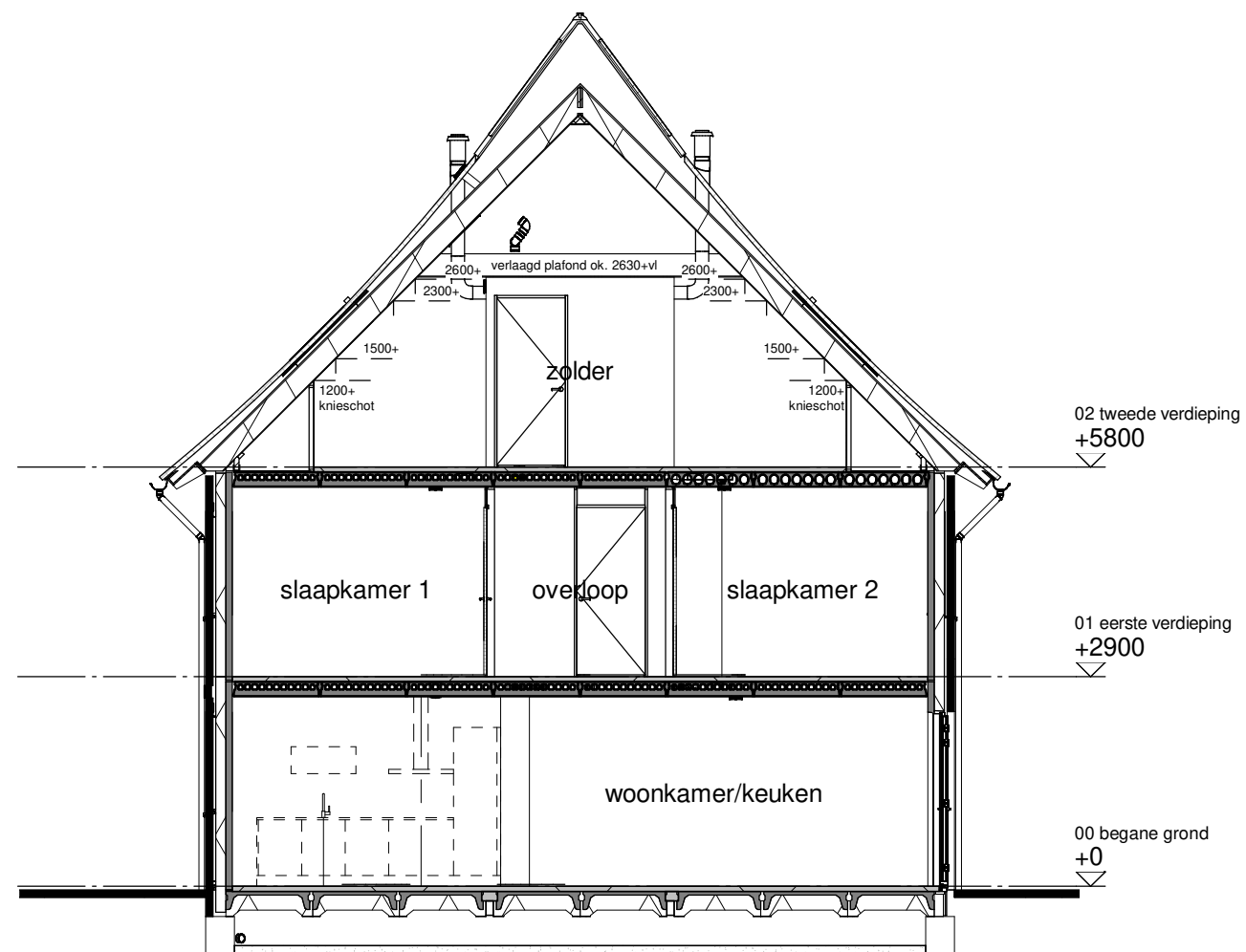

Type: Z45  
Bouwnummer: 236

Doorsnede B

**ALLEMAAL  
YIELEYAAL**

Tekening: Doorsnedes blok K2

Woningtype: Z45, YU

Bouwnummer: 235 t/m 243

Bladnummer: VT-K2-00c

Schaal: 1:100

Datum: 30-01-2024

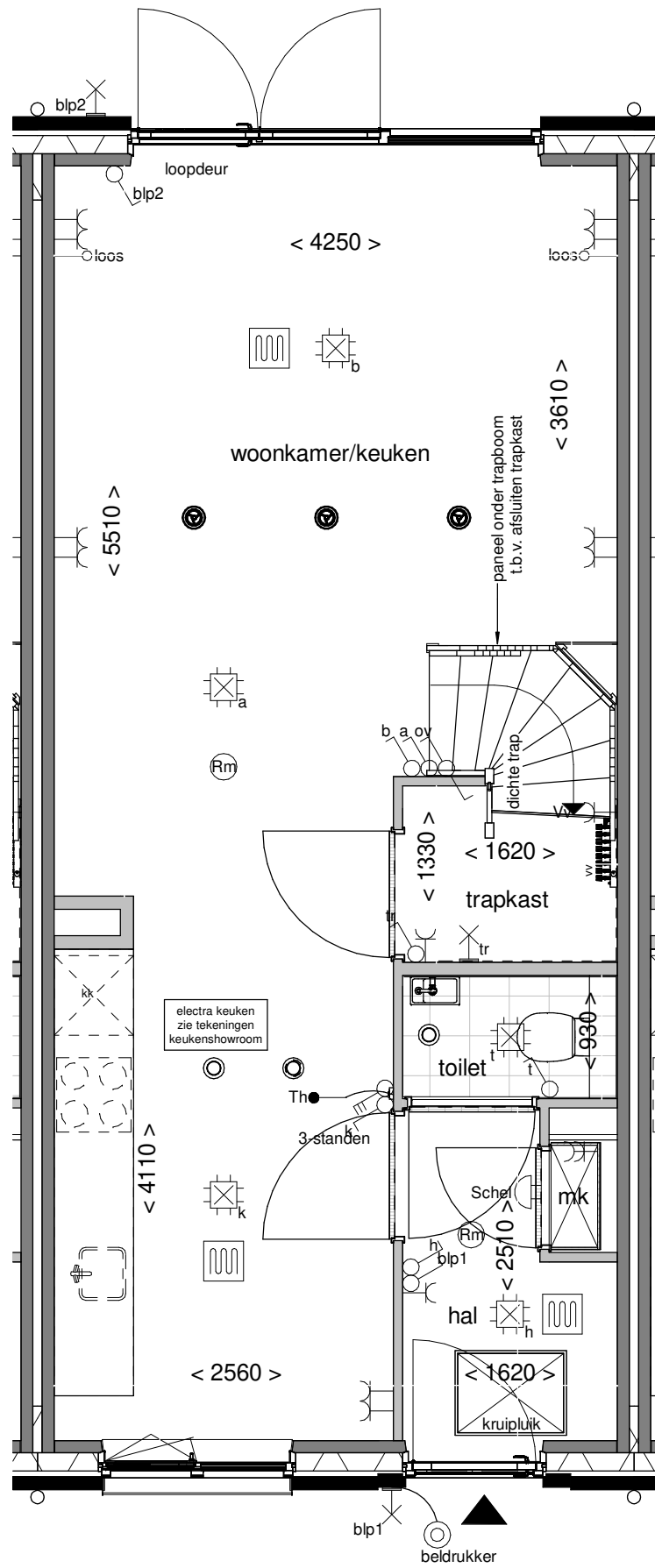

**ALLEMAAL  
VIELEVAAL**

Tekening: Begane grond

Woningtype: Z45

Bouwnummer: 238

Bladnummer: VT-K2-238a

Schaal: 1:50

Datum: 30-01-2024

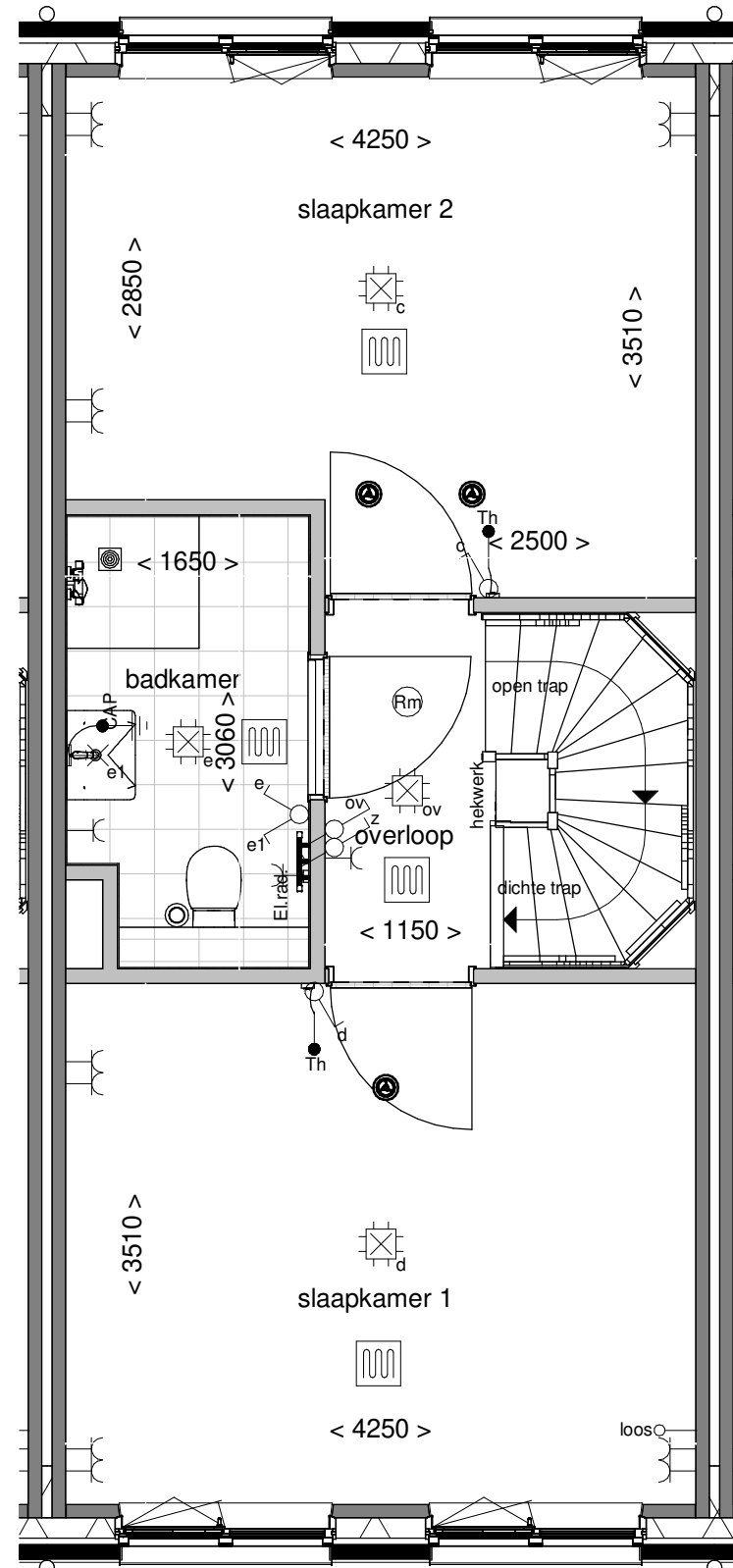

**ALLEMAAL  
VIELEJAAL**

Tekening: Eerste verdieping

Woningtype: Z45

Bouwnummer: 238

Bladnummer: VT-K2-238b

Schaal: 1:50

Datum: 30-01-2024







Voorgevel

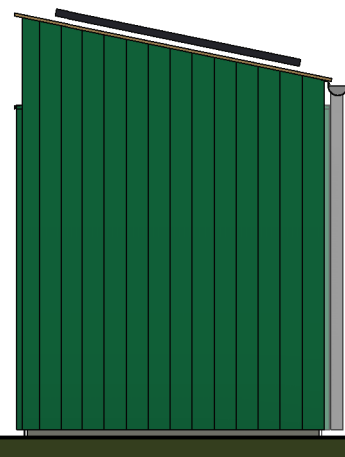

Linker zijgevel

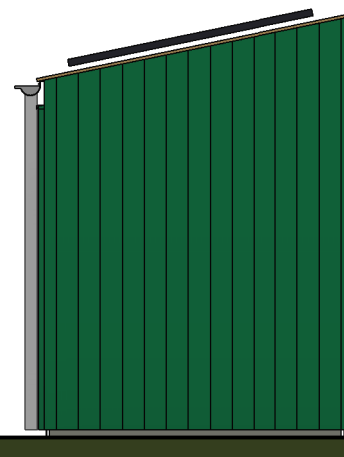

Rechter zijgevel

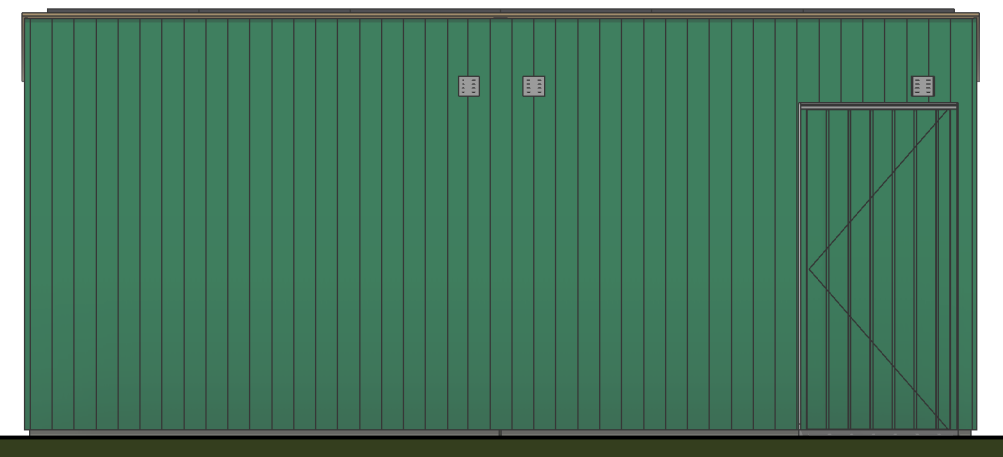

Achtergevel

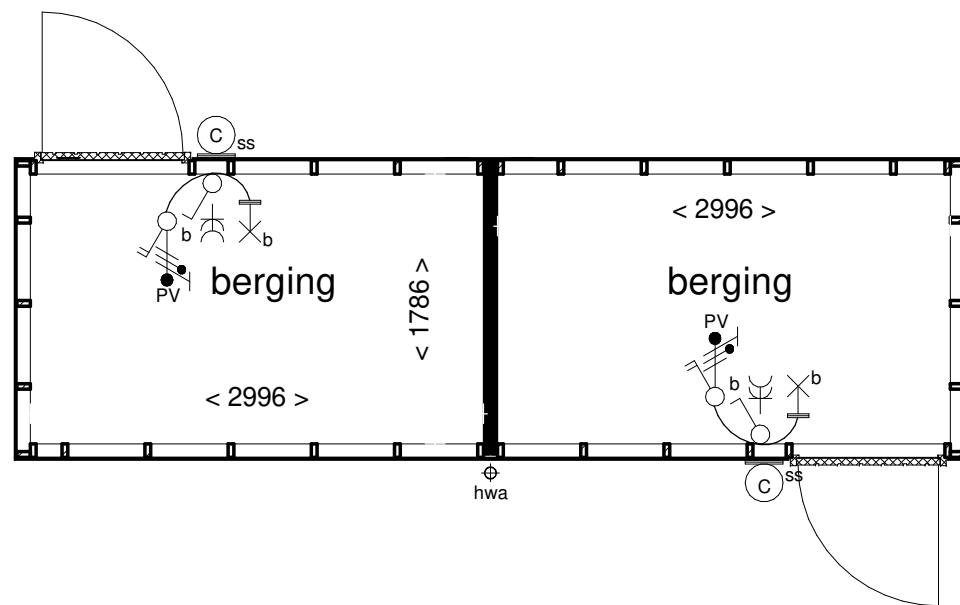

Begane grond

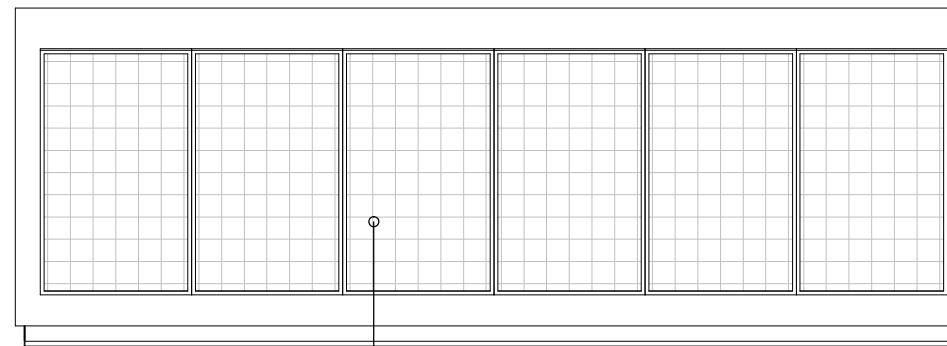

maximaal aantal pv-panelen weergegeven  
aantal kan verschillen per woning/berging

Dakaanzicht

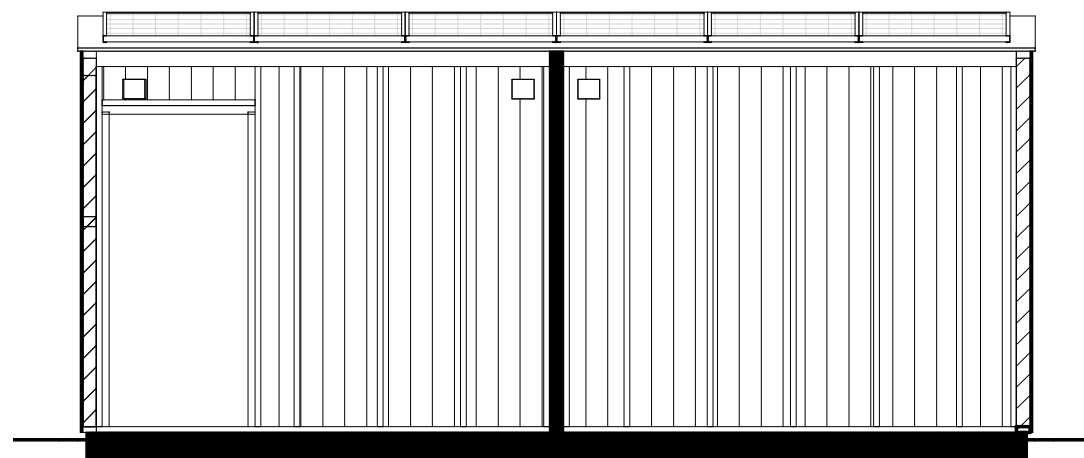

Doorsnede A-A

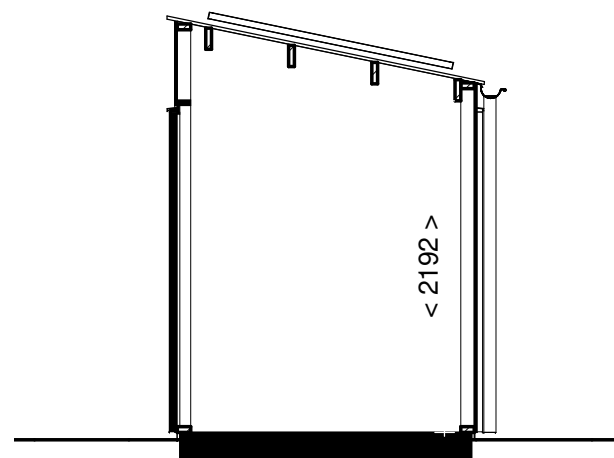

Doorsnede B-B

**Als getekend:**

- bnr. 236 - 237
- bnr. 238 - 239
- bnr. 240 - 241
- bnr. 242 - 243
- bnr. 272 - 273
- bnr. 274 - 275
- bnr. 276 - 277
- bnr. 278 - 279
- bnr. 280 - 281
- bnr. 282 - 283
- bnr. 284 - 285
- bnr. 286 - 287
- bnr. 288 - 289
- bnr. 290 - 291
- bnr. 292 - 293

**Gespiegeld:**

- bnr. 261 - 262
- bnr. 263 - 264
- bnr. 296 - 297
- bnr. 298 - 299

**ALLEMAAL  
YIELEYAAL**

Tekening: **Berging A**

Woningtype: -

Bouwnummer:

Bladnummer: **VT-BE01**

Schaal: **1:50**

Datum: **30-01-2024**

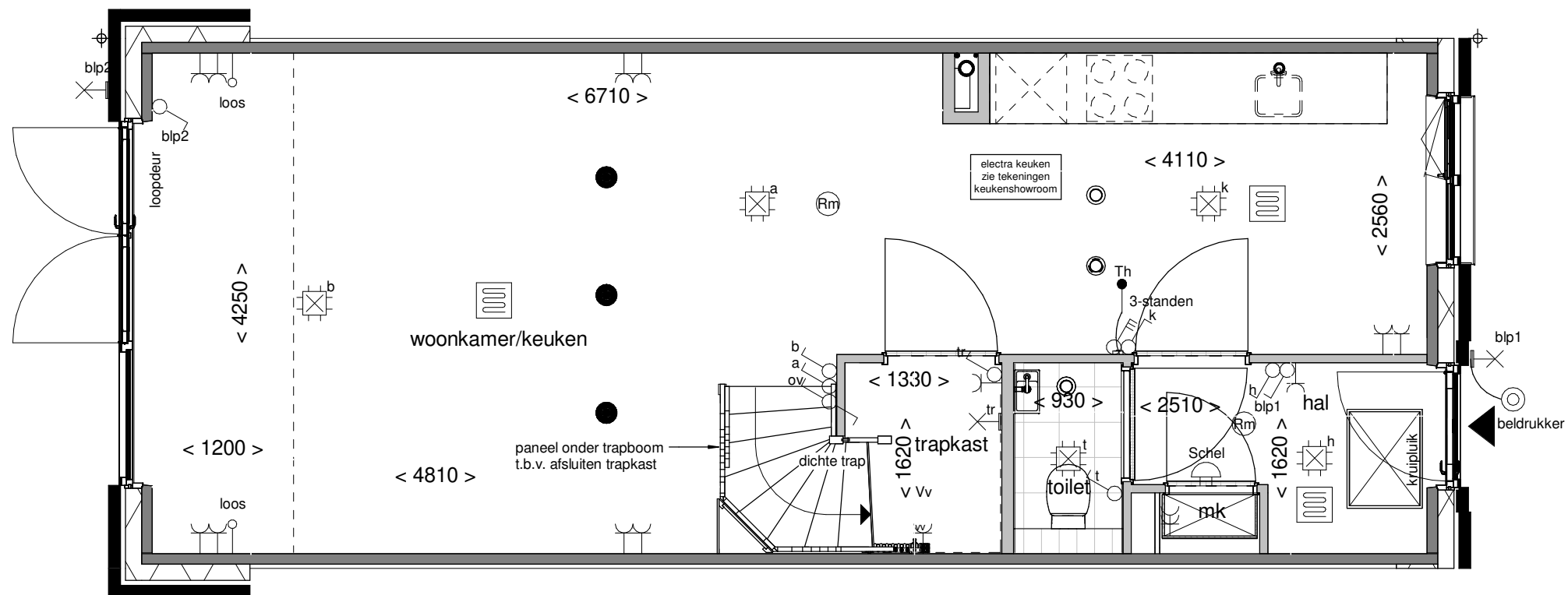

Achtergevel schaal 1:100

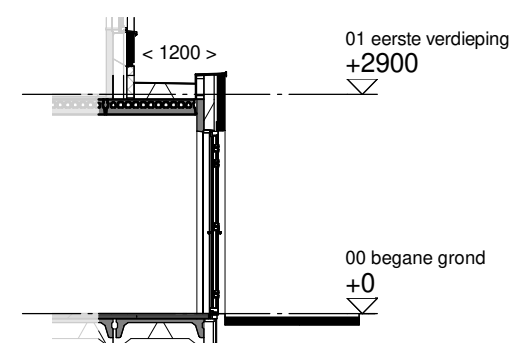

Doorsnede schaal 1:100

**ALLEMAAL  
VIELEYAAL**

Optie: **Uitbouw achtergevel  
1200mm**

Woningtype: **Z45**

Bouwnummer: -

Optienummer: **0.A.Z.14**

Schaal: **1:50 / 1:100**

Datum: **30-01-2024**

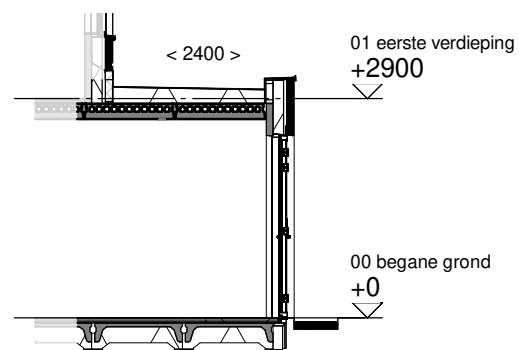
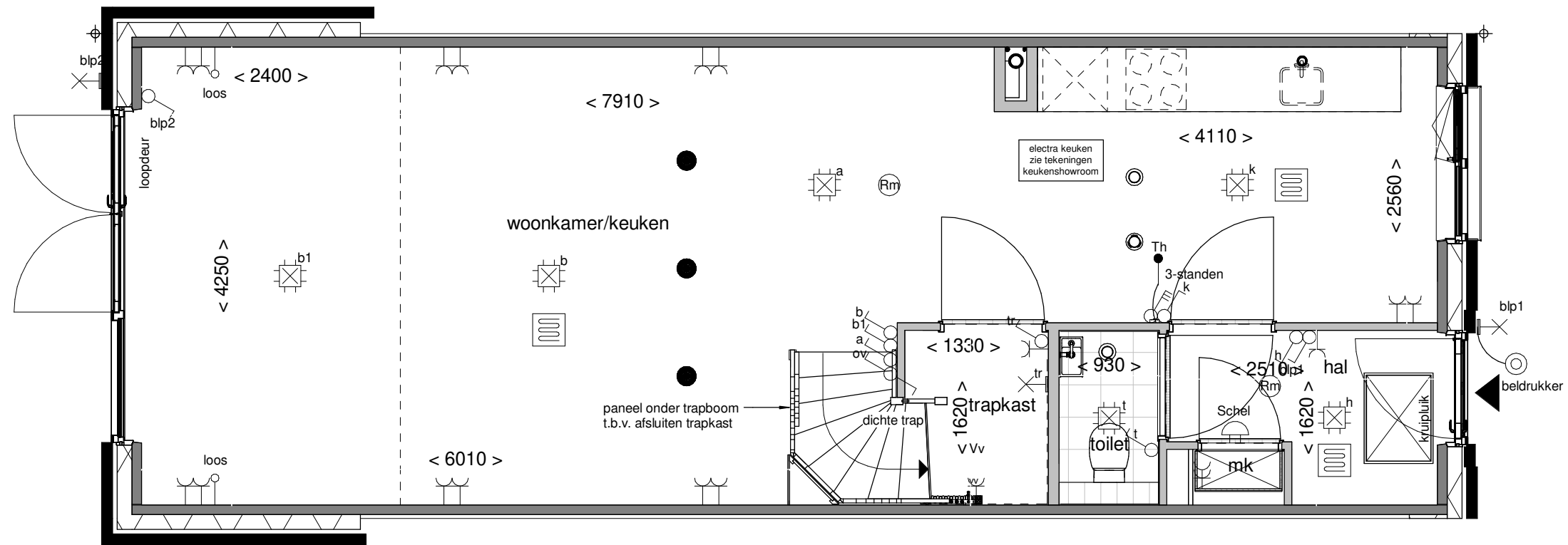

Doorsnede schaal 1:100



Achtergevel schaal 1:100

**ALLEMAAL  
VIELEYAAL**

Optie: **Uitbouw achtergevel  
2400mm**

Woningtype: **Z45**

Bouwnummer: -

Optienummer: **0.A.Z.34**

Schaal: **1:50 / 1:100**

Datum: **30-01-2024**

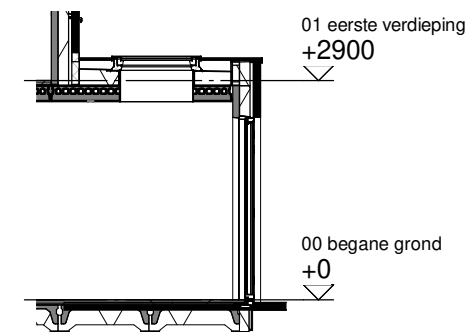
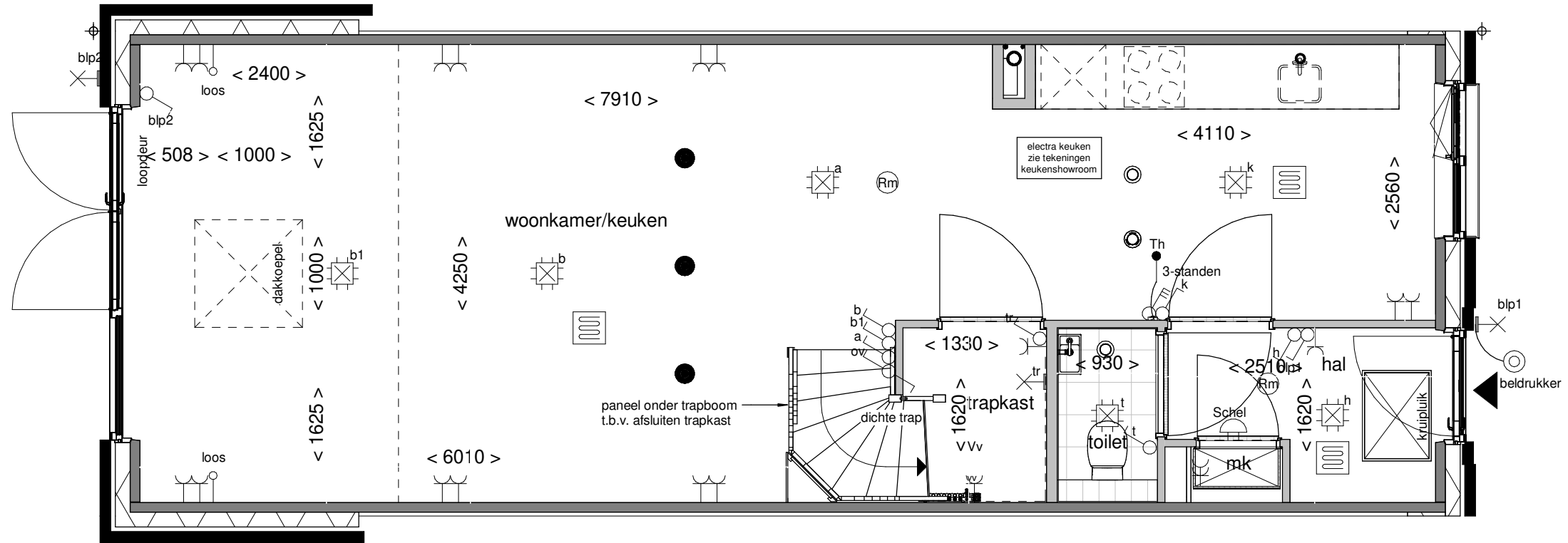

Doorsnede schaal 1:100

**ALLEMAAL  
VIELEYAAL**

Optie: Lichtkoepel in  
uitbouw 2400mm

Woningtype: Z45

Bouwnummer: -

Optienummer: 1.B.X.10

Schaal: 1:50 / 1:100

Datum: 30-01-2024

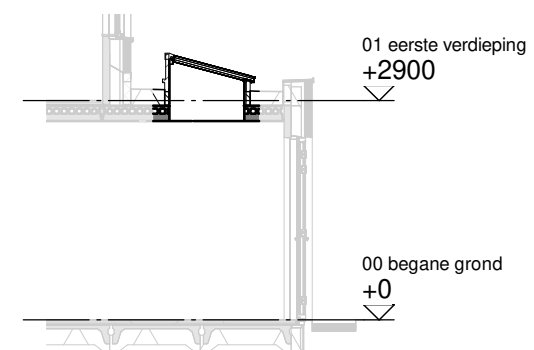
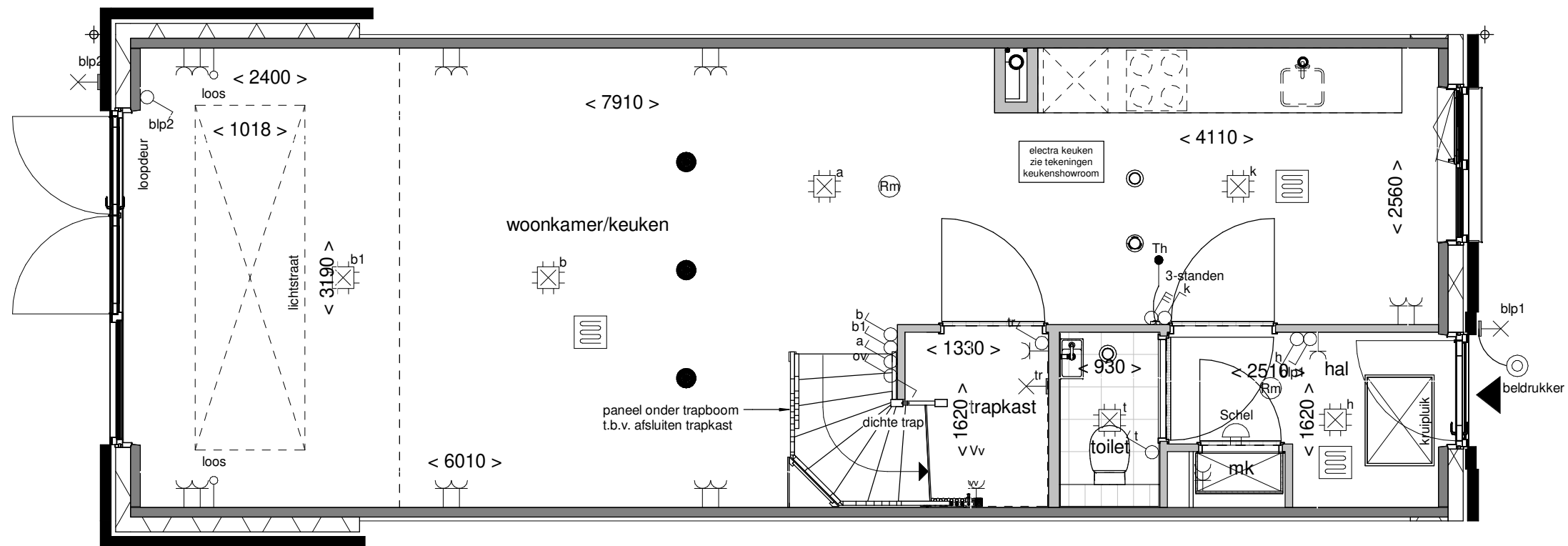

Doorsnede schaal 1:100

**ALLEMAAL  
VIELEYAAL**

Optie: Lichtstraat in uitbouw  
2400mm

Woningtype: Z45

Bouwnummer: -

Optienummer: 1.B.X.14

Schaal: 1:50 / 1:100

Datum: 30-01-2024

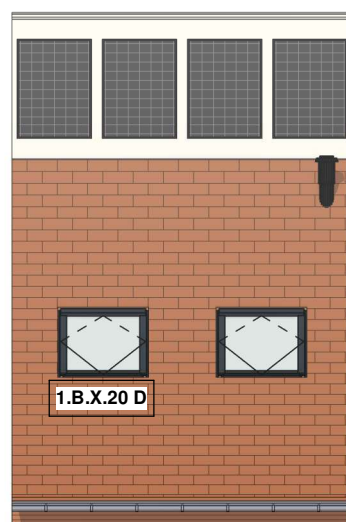
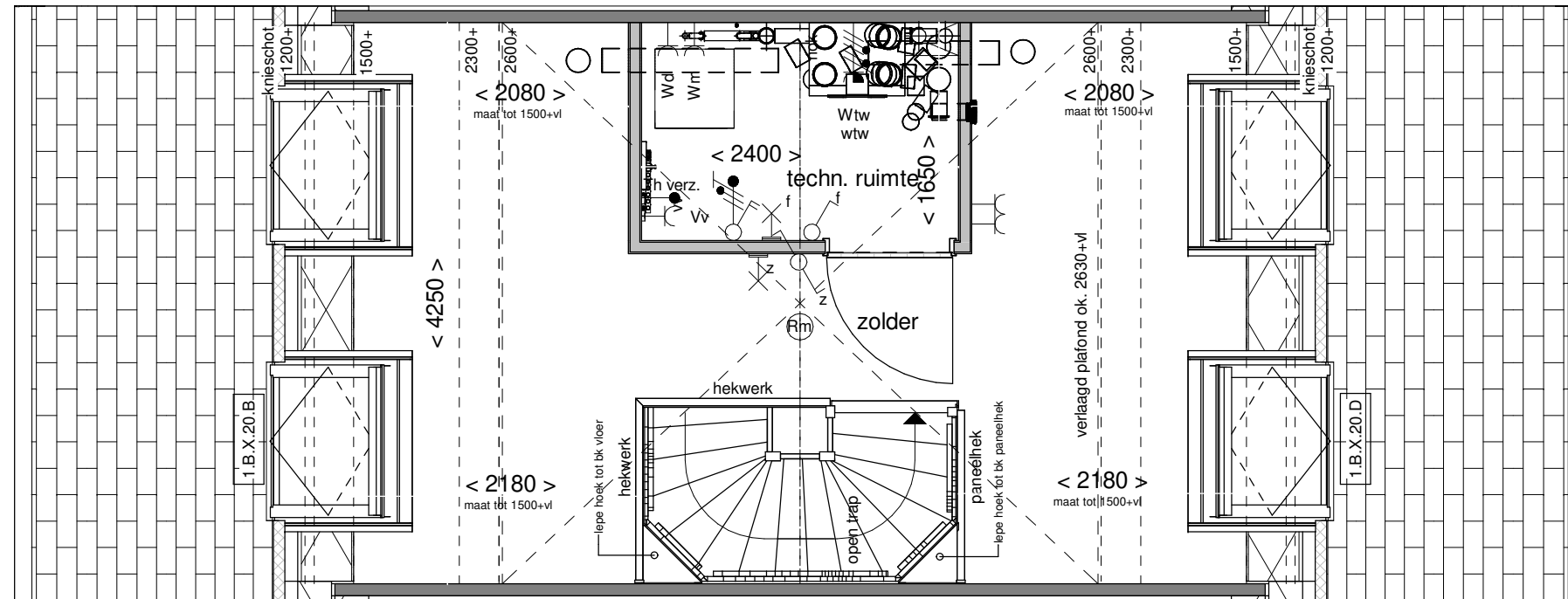

Voorgevel schaal 1:100

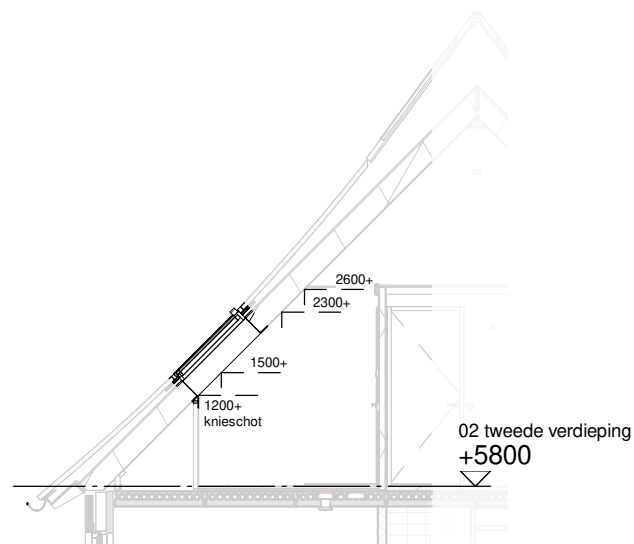

Doorsnede schaal 1:100

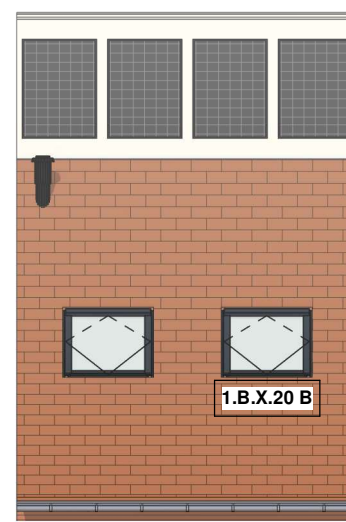

Achtergevel schaal 1:100

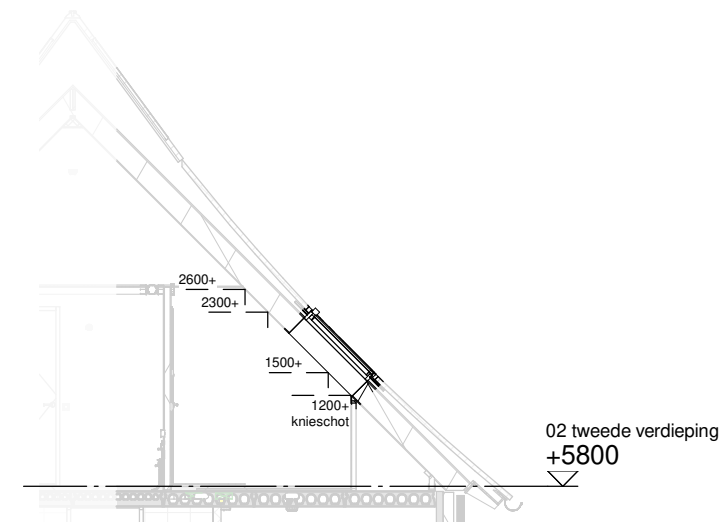

Doorsnede schaal 1:100

**ALLEMAAL  
YIELEYAAL**

Optie: Dakramen voor- en achtergevel

Woningtype: Z45

Bouwnummer: -

Optienummer: 1.B.X.20

Schaal: 1:50 / 1:100

Datum: 30-01-2024

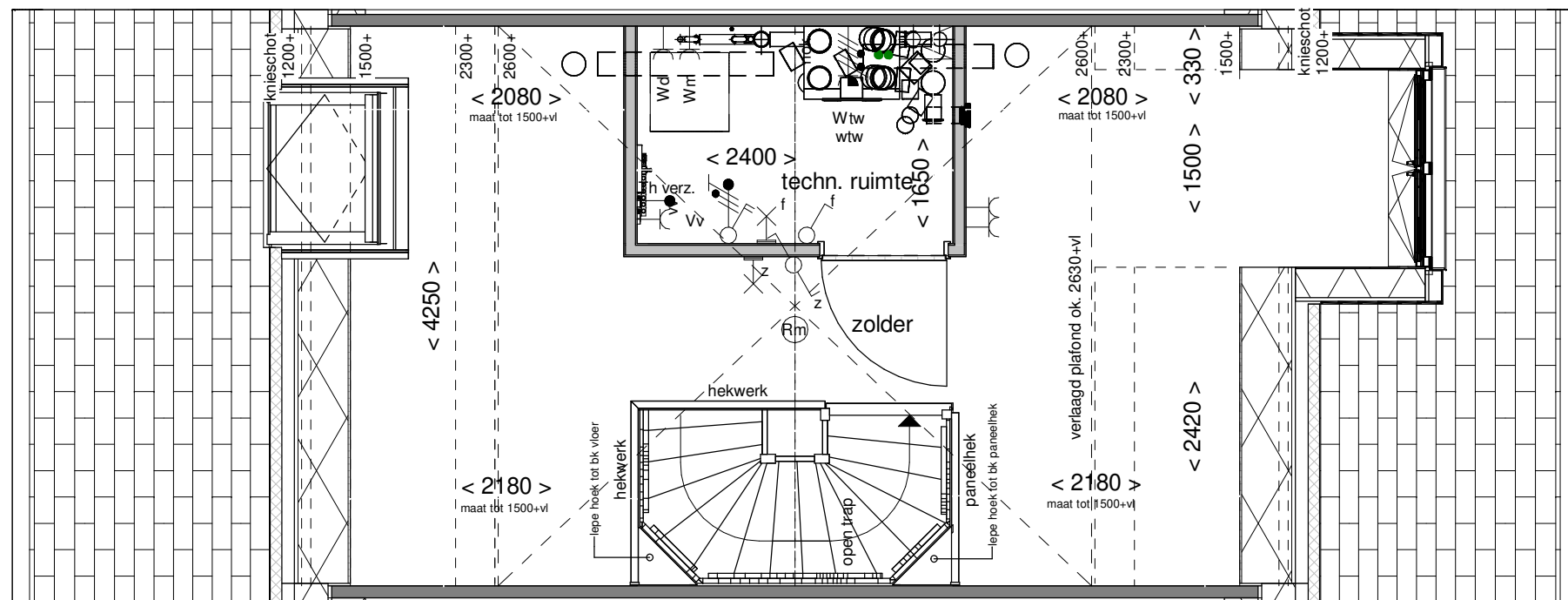

Voorgevel schaal 1:100

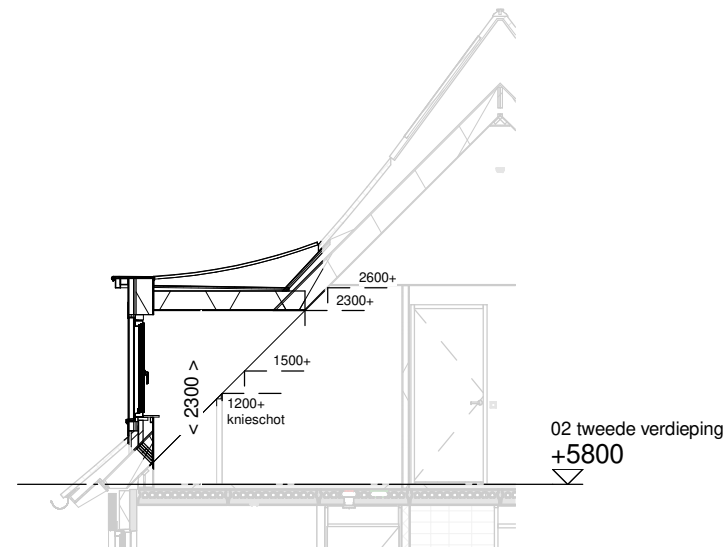

Doorsnede schaal 1:100

**ALLEMAAL  
VIELEYAAL**

Optie: Dakkapel  
voorgevel 1500mm

Woningtype: Z45

Bouwnummer: -

Optienummer: 1.B.X.33

Schaal: 1:50 / 1:100

Datum: 30-01-2024



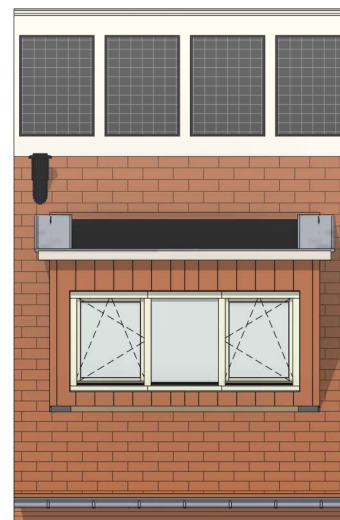
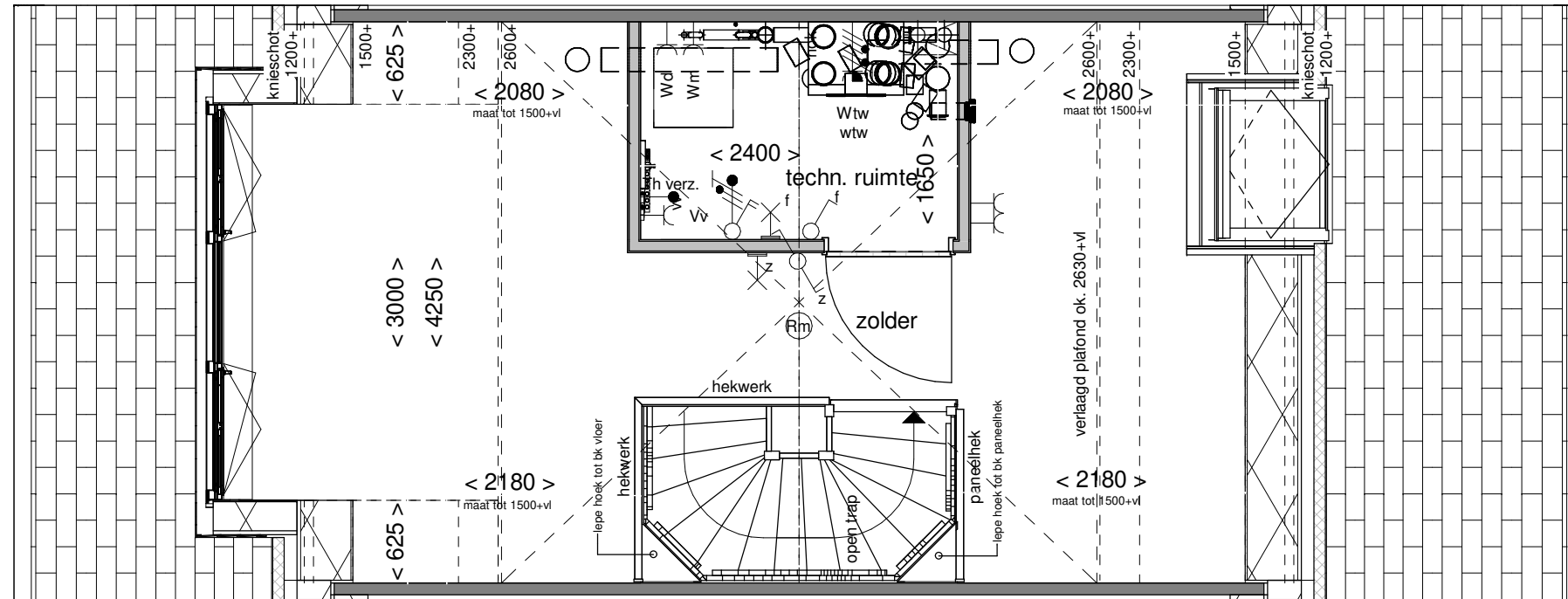

Achtergevel schaal 1:100

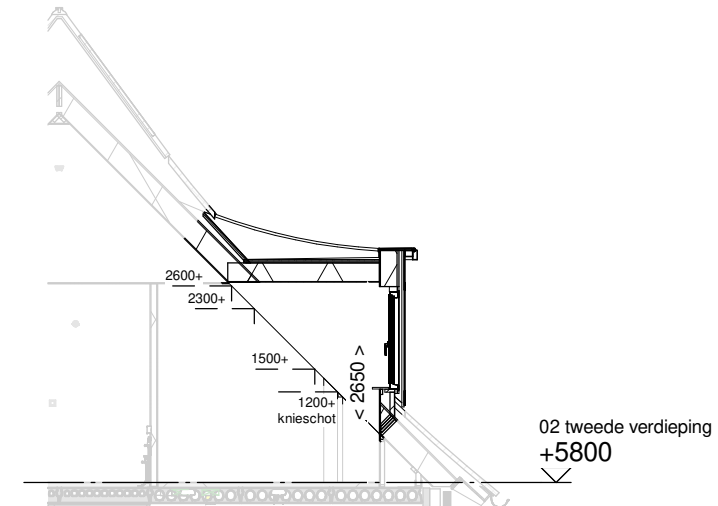

Achtergevel schaal 1:100

**ALLEMAAL  
VIELEYAAL**

Optie: Dakkapel  
achtergevel 3000mm

Woningtype: Z45

Bouwnummer: -

Optienummer: 1.B.X.34

Schaal: 1:50 / 1:100

Datum: 30-01-2024

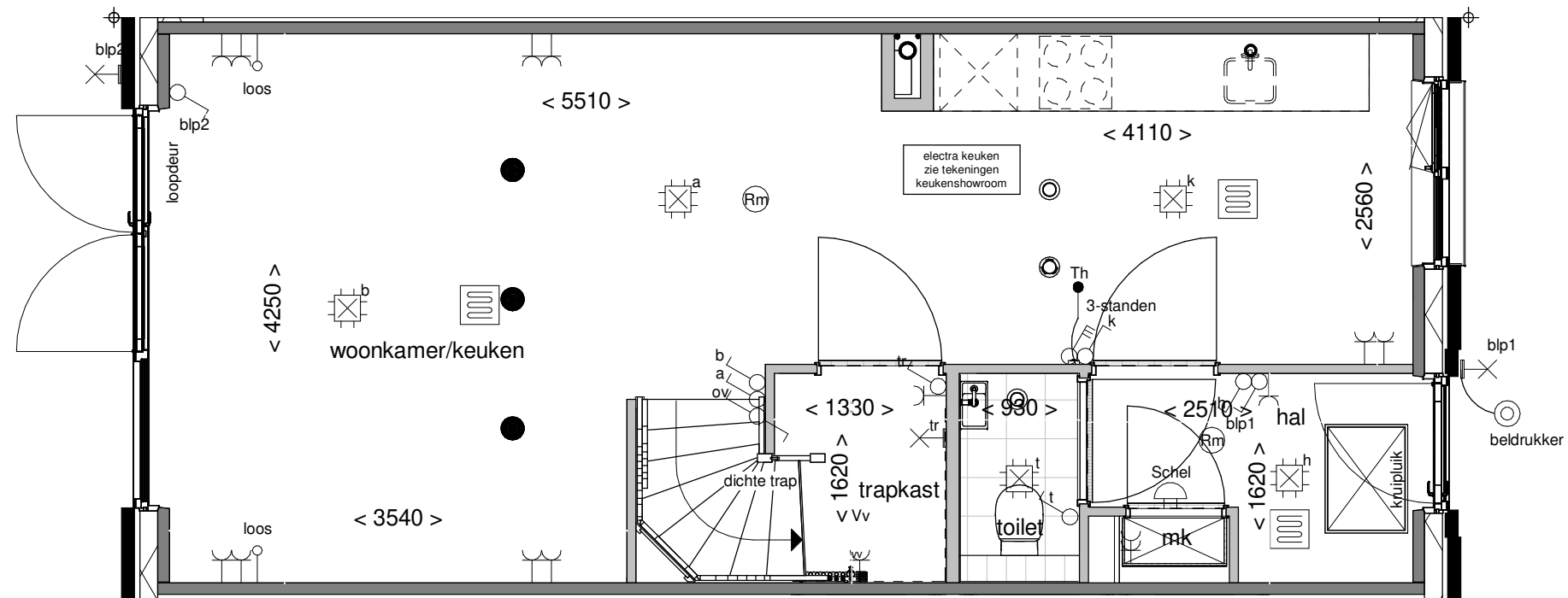

**ALLEMAAL  
YIELEYAAL**

Optie: Wand naast trap

Woningtype: Z45

Bouwnummer: -

Optienummer: 1.C.Z.10

Schaal: 1:50

Datum: 30-01-2024

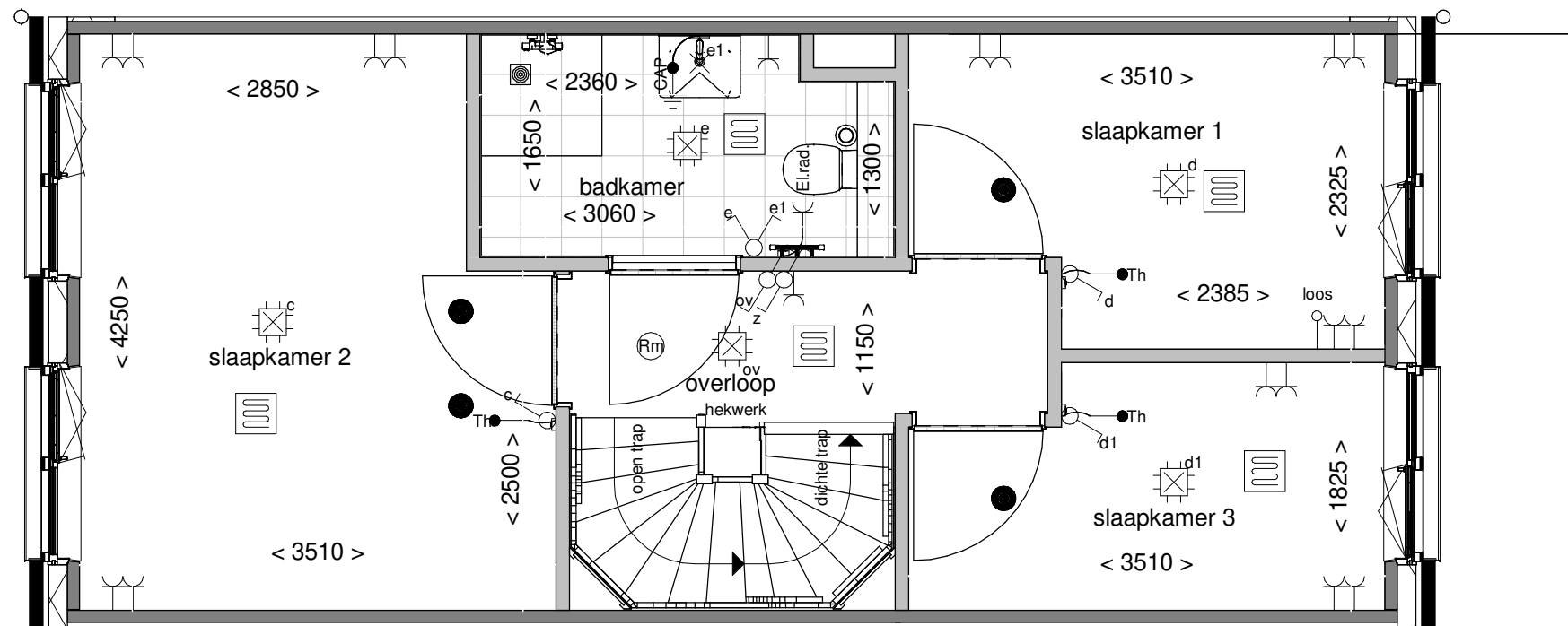

**ALLEMAAL  
VIELEYAAL**

Optie: Twee slaapkamers  
voorzijde

Woningtype: Z45

Bouwnummer: -

Optienummer: 1.C.Z.36

Schaal: 1:50

Datum: 30-01-2024

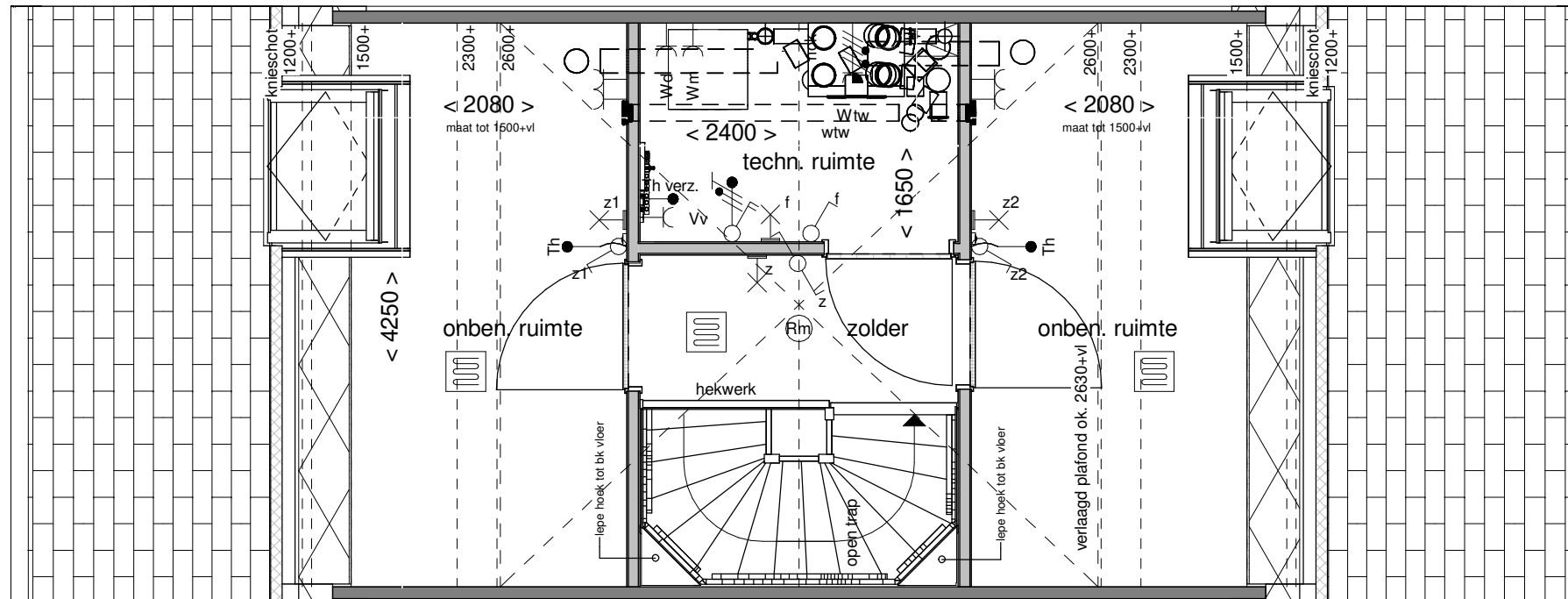

**ALLEMAAL  
VIELEYAAL**

Optie: Indeling techn.- en  
2 onb. ruimtes

Woningtype: Z45

Bouwnummer: -

Optienummer: 1.C.Z.76

Schaal: 1:50

Datum: 30-01-2024