

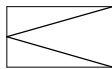

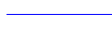







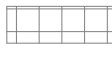

**ALLEMAAL
YIELEYAAL**

Tekening: Situatie Fase 5-6
 Woningtype: _____
 Bouwnummer: _____
 Bladnummer: VT-S-01
 Schaal: 1:1000
 Datum: 17-06-2024

Renvooi

-  - entree woning
-  - parkeervak eigen terrein
-  - erfgrans
-  - struik type n.t.b. koper
-  - opstelplaats kliko
-  - tuinhekje
-  - klinkerbestrating
-  - betontegels 300x300mm
-  - groen strook
-  - haag h=900mm
-  - haag h=1800mm
-  - bamboehek h=1800mm
-  - gaashek met klimplanten en poort h=1600mm
-  - klimplant
-  - Slagboom met kast type ntb
-  - Straatverlichting

parkeerplekken en posities bomen, struiken en straatverlichting zijn indicatief











Slagboom met kast type ntb; aangesloten op elektra/data in mantelbuis hoekwoning



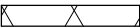

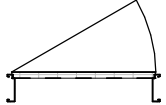
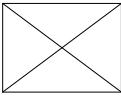
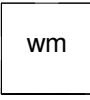

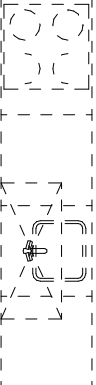





















**ALLEMAAL
YIELEYAAL**

Tekening: Situatie Blok J2
 Woningtype: Z45
 Bouwnummer: 219-226
 Bladnummer: VT-S-13
 Schaal: 1:200
 Datum: 17-06-2024

Renvooi bouwkundig

	metselwerk kleur A
	dakpannen kleur oranje
	entree woning
	metselwerk
	isolatie
	dragende wand
	niet dragende binnenwand
	binnendeurkozijn (met bovenlicht)
	kruipluik
	opstelplaats wasmachine
	opstelplaats wasdroger
	
	principe opstelling keukenblok

Renvooi installaties

	aansluitpunt licht
	aansluitpunt licht, wand
	centraaldoos met lichtpunt
	armatuur aan de wand
	rookmelder
	aansluitpunt niet bedraad
	verdeelinrichting / meterkast / groepenkast
	beldrukker
	schel
	schakelaar, 1-polig
	werkschakelaar tbv PV-panelen
	schakelaar, 3-polig
	schakelaar, wissel
	schakelaar, kruis
	schakelaar, serie
	wandcontactdoos 1-voudig met beschermingscontact
	wandcontactdoos 2-voudig met beschermingscontact, verticaal
	wandcontactdoos 2-voudig met beschermingscontact
	thermostaatleiding, bedraad
	mechanische ventilatie-unit incl. warmteterugwinunit
	warmtepomp
	inblaasventiel mechanische ventilatie
	uitblaasventiel mechanische ventilatie
	verdeler vloerverwarming
	Afleverzet stadswarmte
	ruimte voorzien van vloerverwarming
	elektrische radiator
	kanalen in het zicht

Disclaimer

De op deze tekeningen aangegeven maten zijn circa maten in millimeters en tussen de wanden / vloeren gemeten, waarbij geen rekening is gehouden met enige wandafwerking, plinten, aftimmering, ect. In verband met de nauwkeurige uitwerking van details, constructie, maatvoering, materialen e.d. kunnen er kleine afwijkingen ontstaan ten opzichte van de nu vermelde gegevens. Deze geringe afwijkingen geven geen aanleiding tot verrekening. Aan de op deze tekening aangegeven maten kunnen derhalve geen rechten worden ontleend. De op deze tekeningen aangegeven maatvoering is niet geschikt voor opdrachten aan derden door koper(s). De posities van aansluitingen en installatie onderdelen zijn indicatief op tekening aangegeven. De exacte aantallen en posities zullen na berekening in het werk door de installateurs worden bepaald en kunnen afwijken van deze tekening.

**ALLEMAAL
YIELEYAAL**

Tekening: Renvooi

Woningtype: -

Bouwnummer: -

Bladnummer: VT-0-00c

Schaal: -

Datum: 19-10-2023



Type: Z45
bwnr: 226

Type: Z45
bwnr: 225

Type: Z45
bwnr: 224

Type: Z45
bwnr: 223

Type: Z45
bwnr: 222

Type: Z45
bwnr: 221

Type: Z45
bwnr: 220

Type: Z45
bwnr: 219

Vorgevel

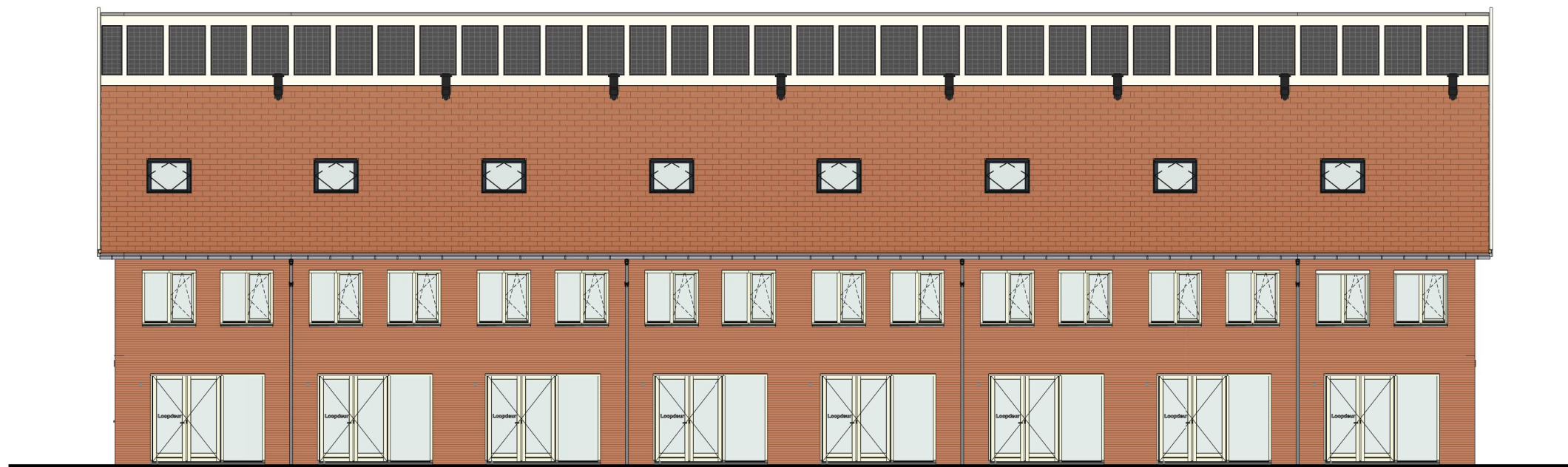

Type: Z45
bwnr: 219

Type: Z45
bwnr: 220

Type: Z45
bwnr: 221

Type: Z45
bwnr: 222

Type: Z45
bwnr: 223

Type: Z45
bwnr: 224

Type: Z45
bwnr: 225

Type: Z45
bwnr: 226

Achtergevel

ALLEMAAL
YIELEYAAL

Tekening: Gevels blok J2

Woningtype: Z45

Bouwnummer: 219 t/m 226

Bladnummer: VT-J2-00a

Schaal: 1:150

Datum: 30-01-2024

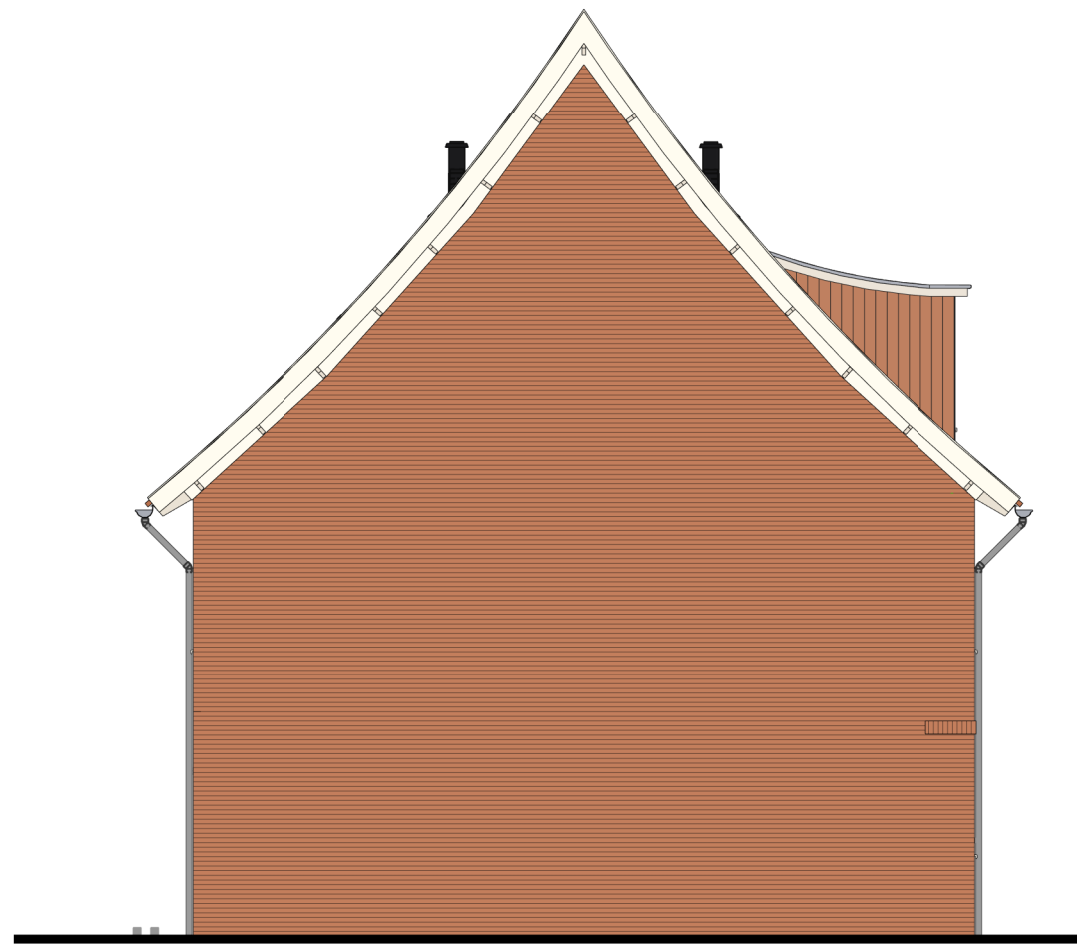

Type: Z45
Bouwnummer: 226

Linker zijgevel



Type: Z45
Bouwnummer: 219

Rechter zijgevel

ALLEMAAL
YIELEYAAL

Tekening: Zijgevels blok J2

Woningtype: Z45

Bouwnummer: 219 t/m 226

Bladnummer: VT-J2-00b

Schaal: 1:100

Datum: 30-01-2024

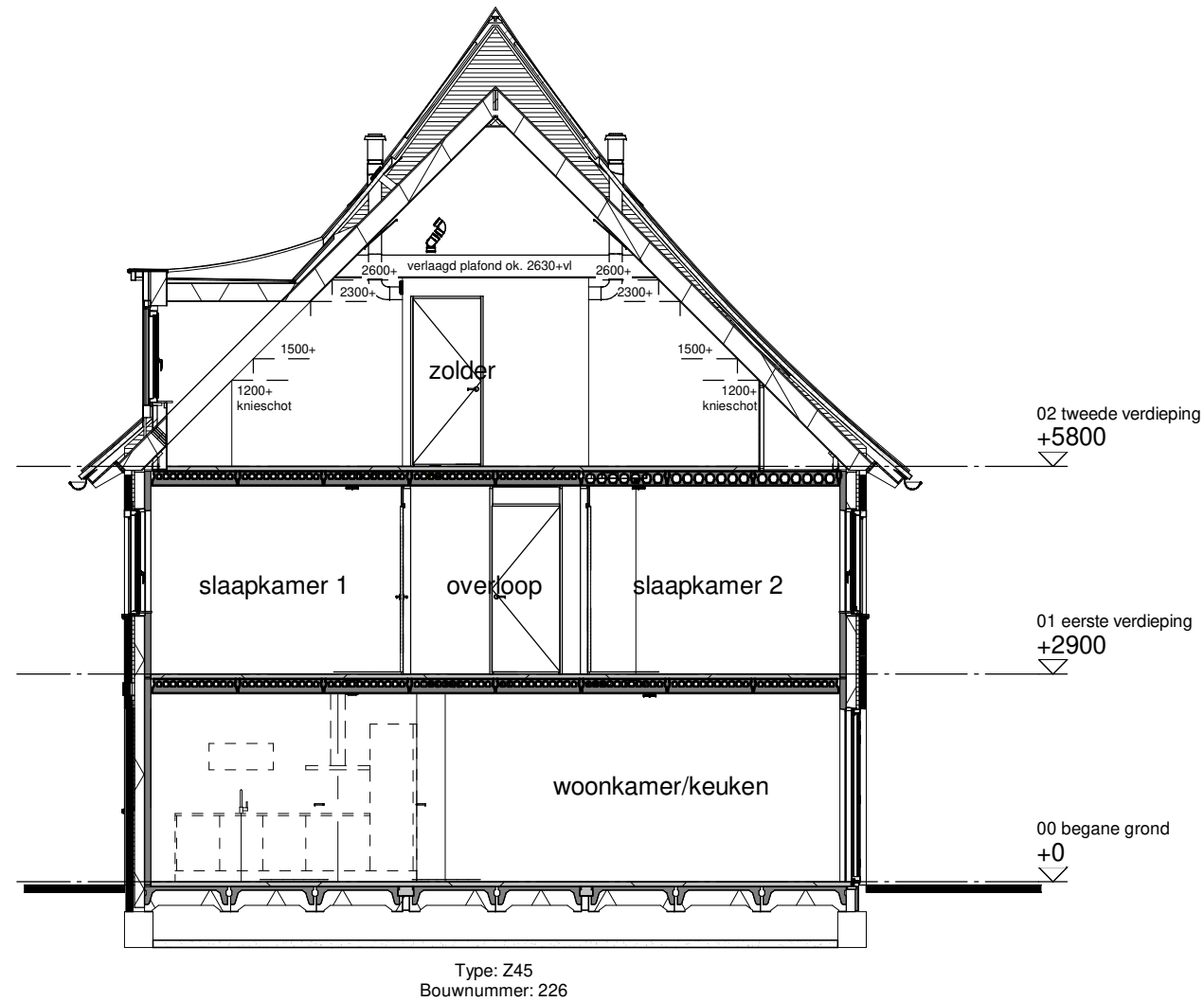

Doorsnede A

ALLEMAAL
YIELEYAAL

Tekening: Doorsnede blok J2

Woningtype: Z45

Bouwnummer: 219 t/m 226

Bladnummer: VT-J2-00c

Schaal: 1:100

Datum: 30-01-2024

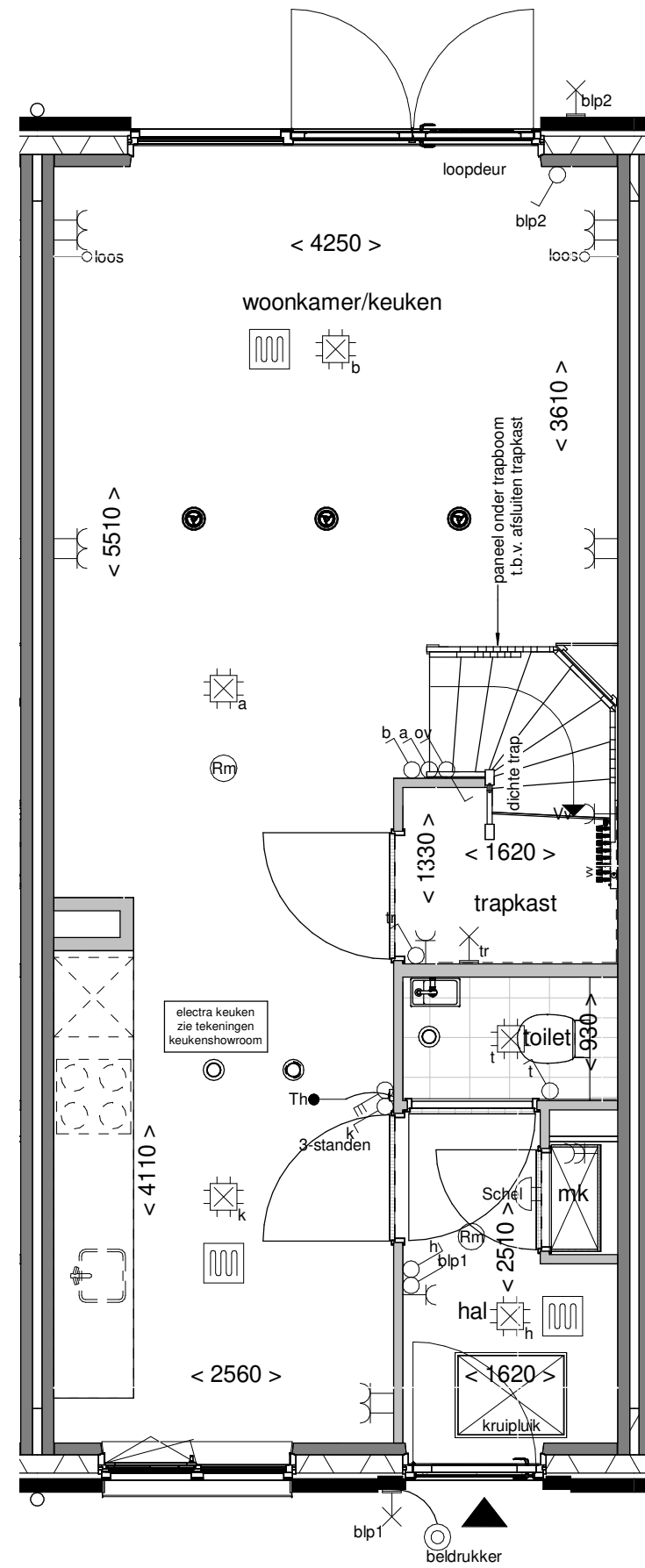

**ALLEMAAL
YIELEYAAL**

Tekening: Begane grond

Woningtype: Z45

Bouwnummer: 223

Bladnummer: VT-J2-223a

Schaal: 1:50

Datum: 30-01-2024

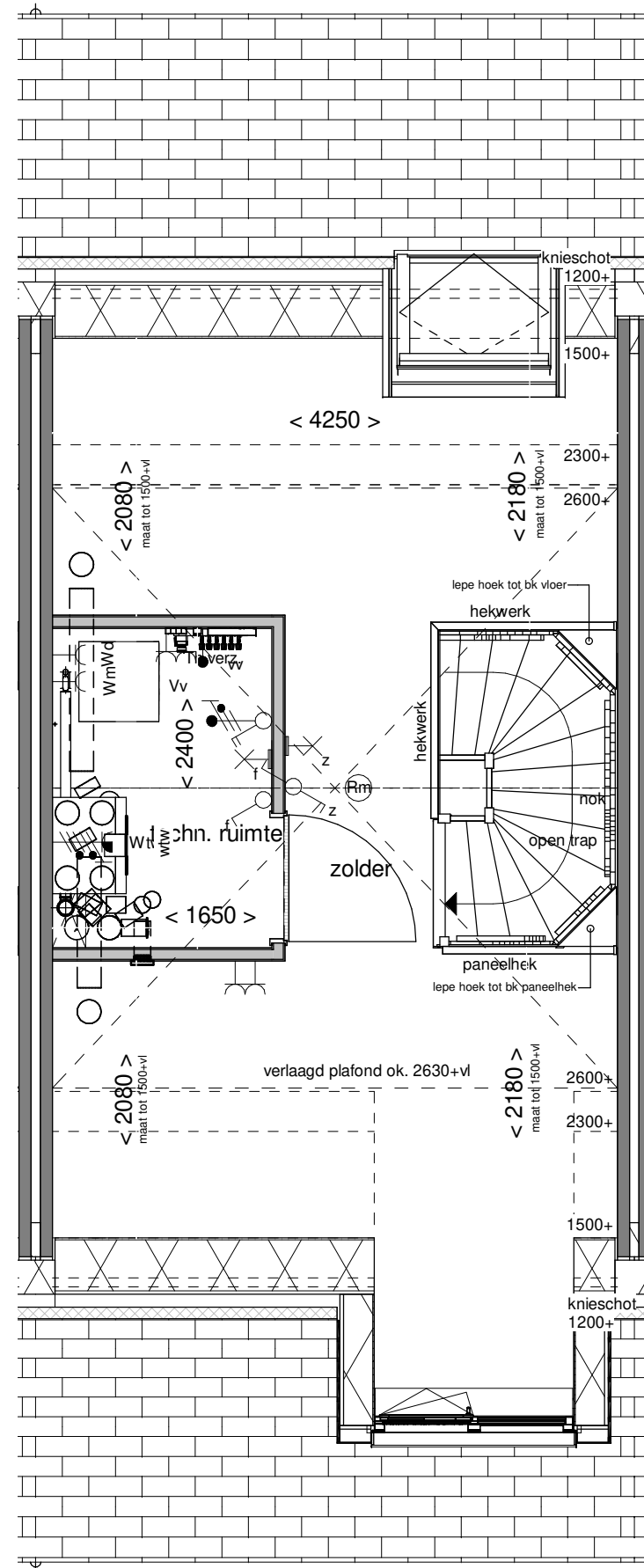

**ALLEMAAL
VIELEJAAL**

Tekening: Tweede verdieping

Woningtype: Z45

Bouwnummer: 223

Bladnummer: VT-J2-223c

Schaal: 1:50

Datum: 30-01-2024

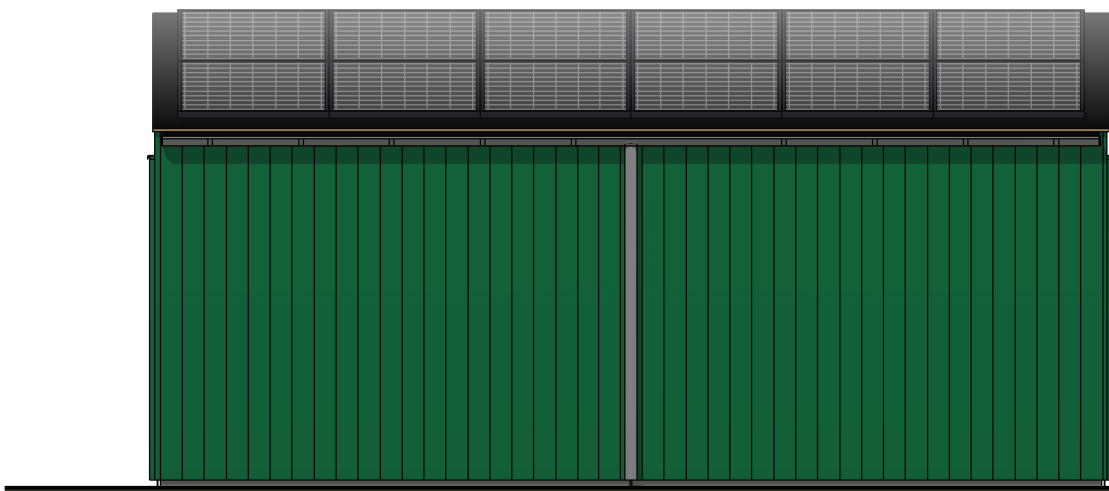

Voorgevel

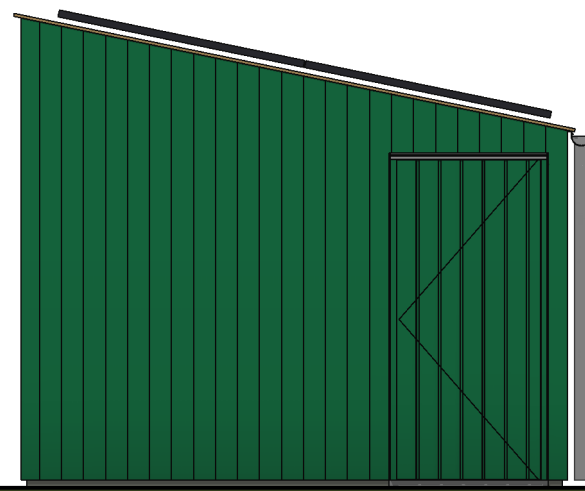

Linker zijgevel

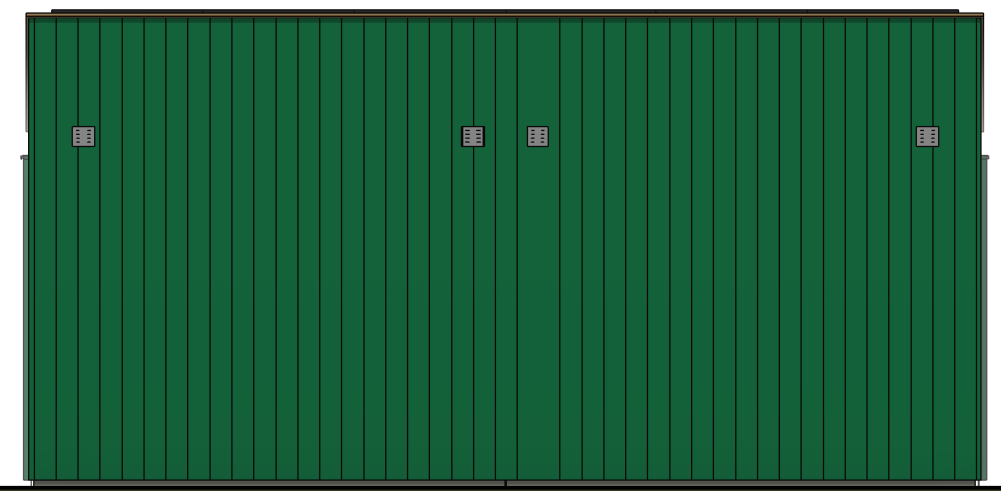

Achtergevel

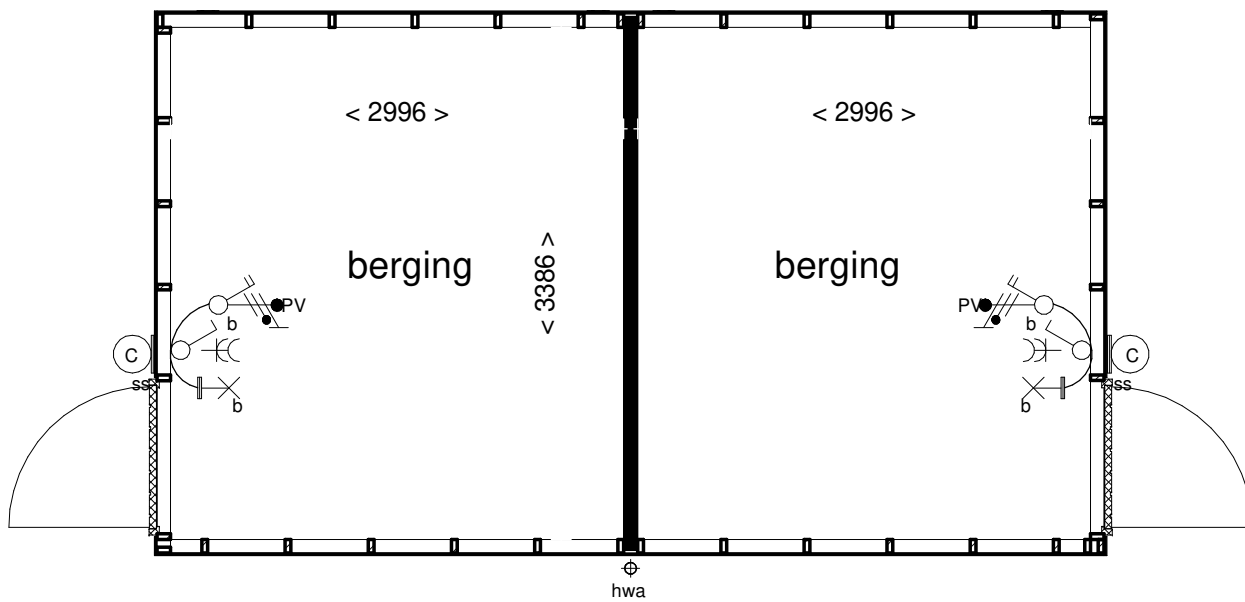

Begane grond

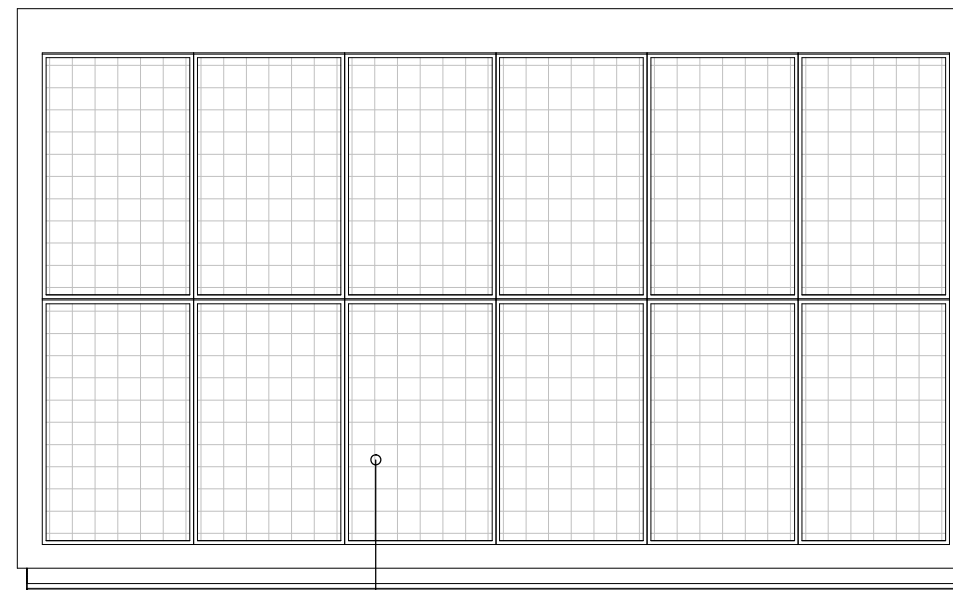

Dakaanzicht

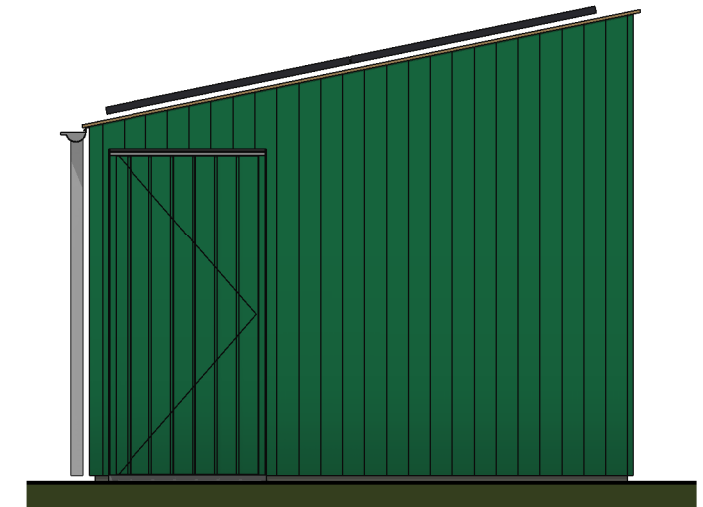

Rechter zijgevel

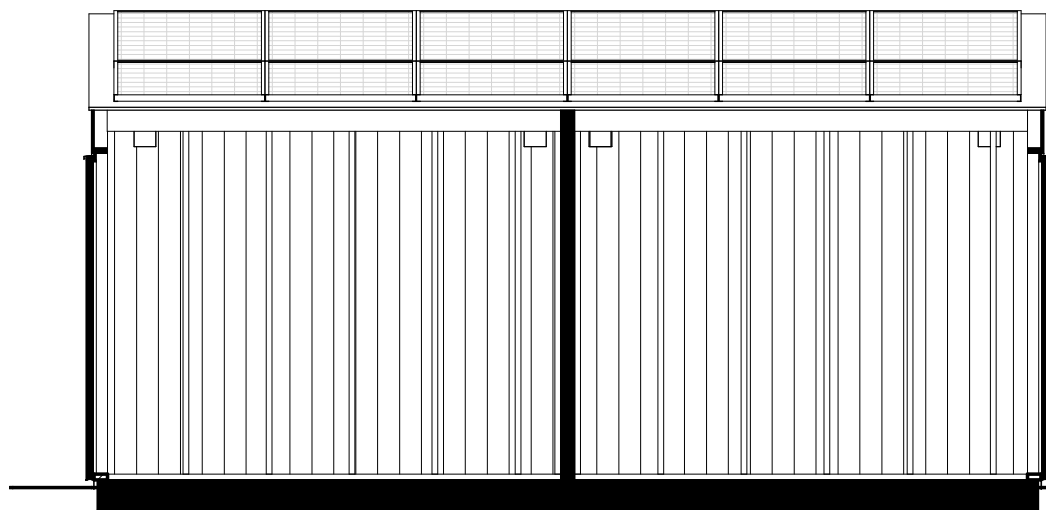

Doorsnede A-A

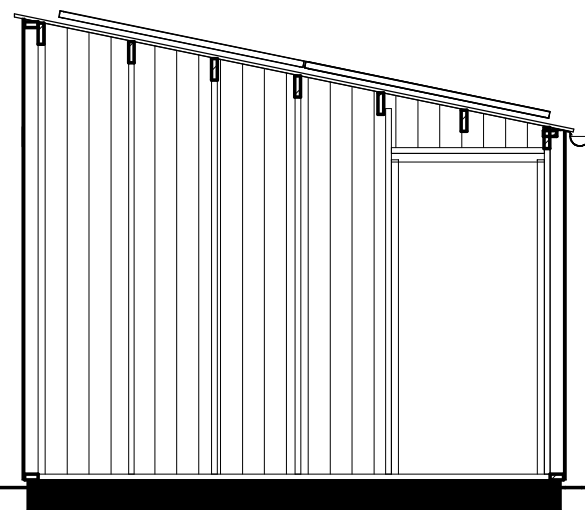

Doorsnede B-B



3D aanzicht

**ALLEMAAL
YIELEYAAL**

Tekening: **Berging B2**

Woningtype: -

Bouwnummer: 209-210,211-212,213-214,215-216,217-218
219-220,221-22,223-224,225-226,227-228
229-230

Bladnummer: **VT-BE03**

Schaal: **1:50**

Datum: **30-01-2024**

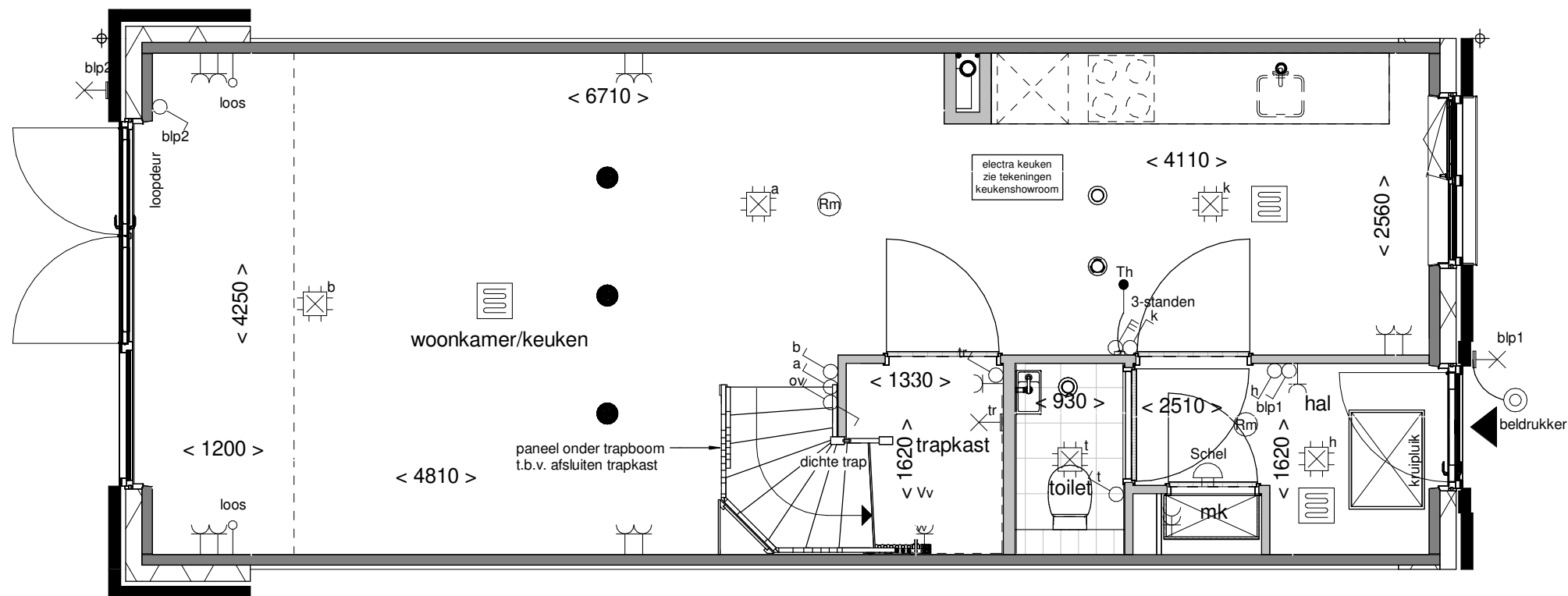

Achtergevel schaal 1:100

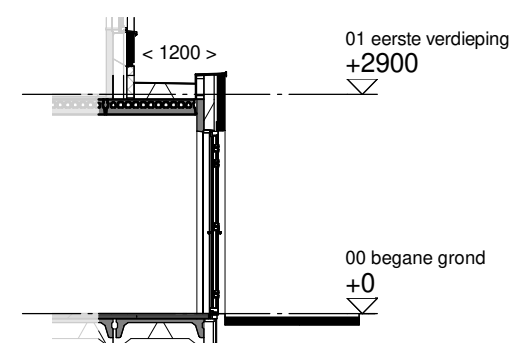

Doorsnede schaal 1:100

**ALLEMAAL
YIELEYAAL**

Optie: **Uitbouw achtergevel
1200mm**

Woningtype: **Z45**

Bouwnummer: -

Optienummer: **0.A.Z.14**

Schaal: **1:50 / 1:100**

Datum: **30-01-2024**

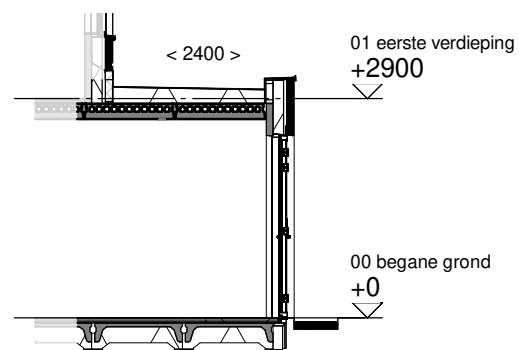
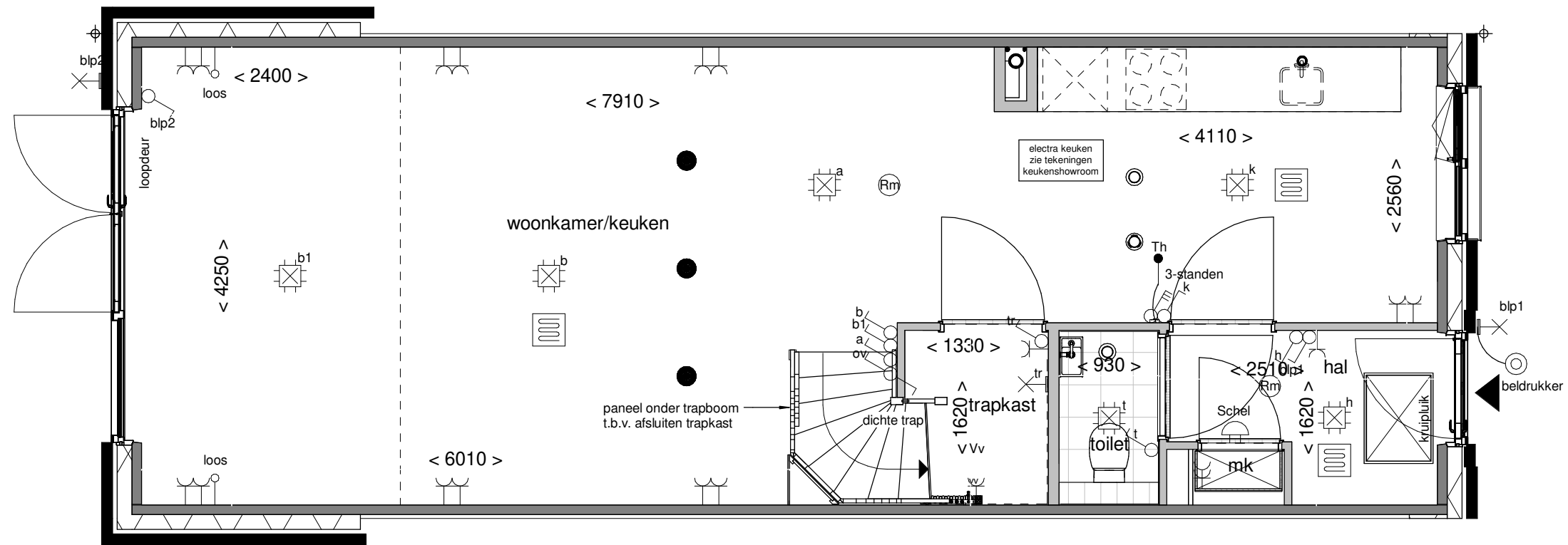

Doorsnede schaal 1:100



Achtergevel schaal 1:100

**ALLEMAAL
VIELEYAAL**

Optie: **Uitbouw achtergevel
2400mm**

Woningtype: **Z45**

Bouwnummer: -

Optienummer: **0.A.Z.34**

Schaal: **1:50 / 1:100**

Datum: **30-01-2024**

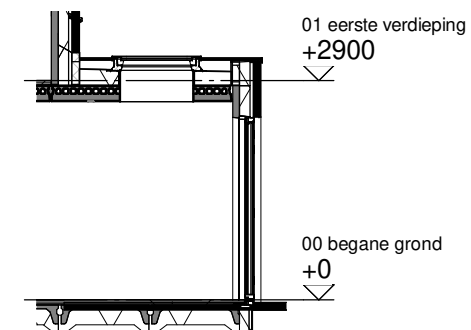
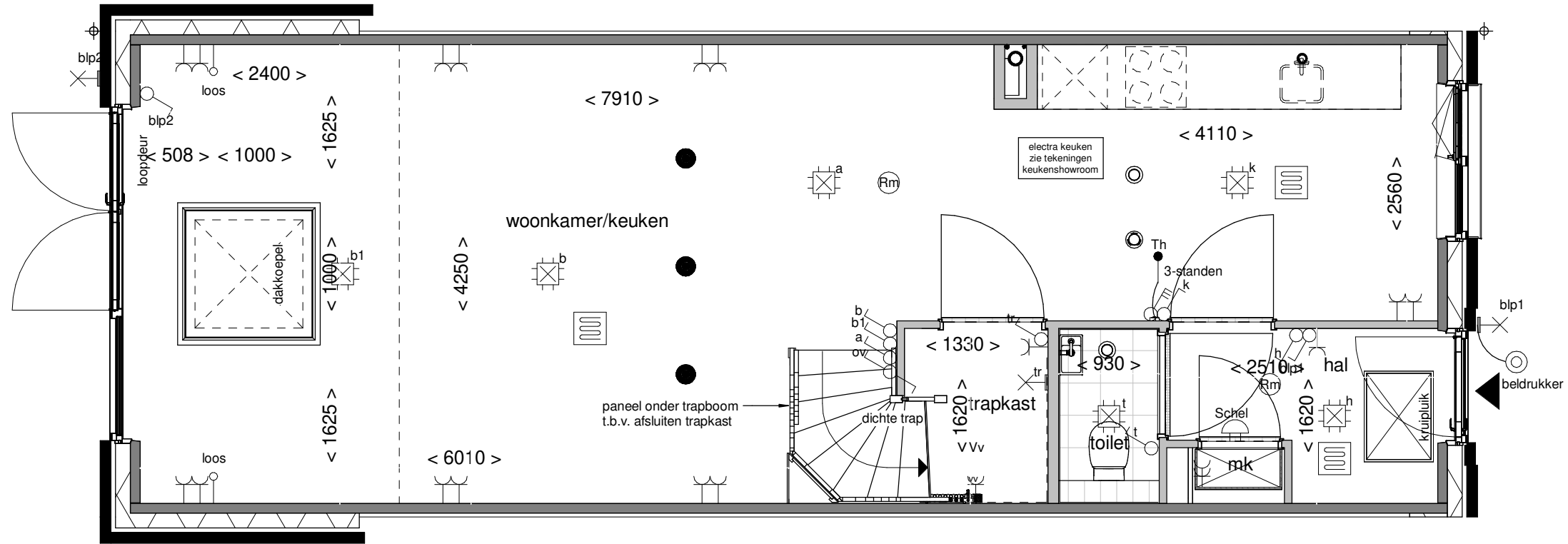

Doorsnede schaal 1:100

**ALLEMAAL
VIELEYAAL**

Optie: Lichtkoepel in
uitbouw 2400mm

Woningtype: Z45

Bouwnummer: -

Optienummer: 1.B.X.10

Schaal: 1:50 / 1:100

Datum: 30-01-2024

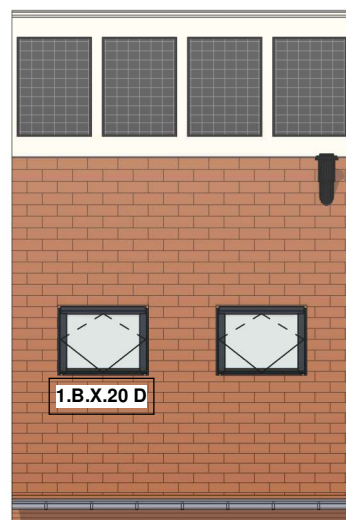
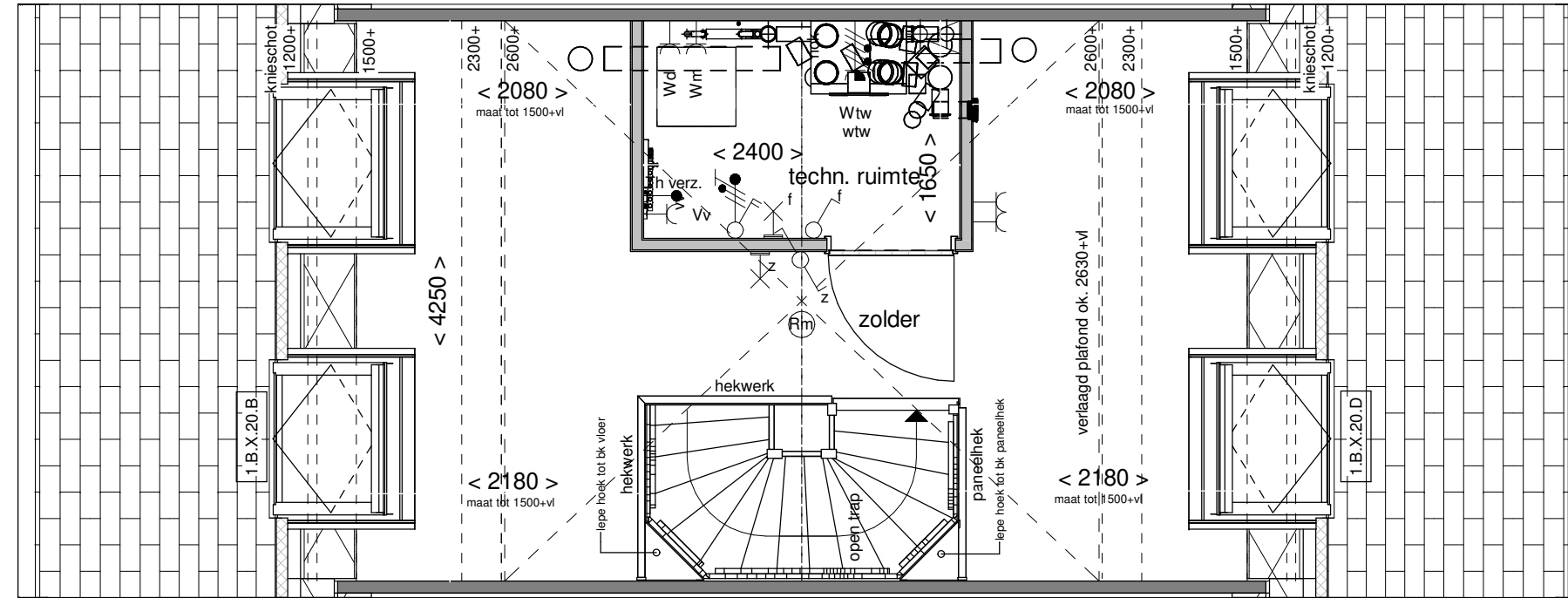

Voorgevel schaal 1:100

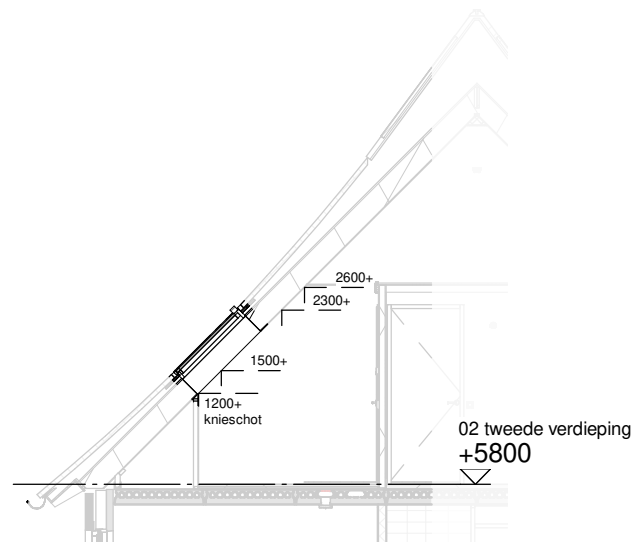

Doorsnede schaal 1:100

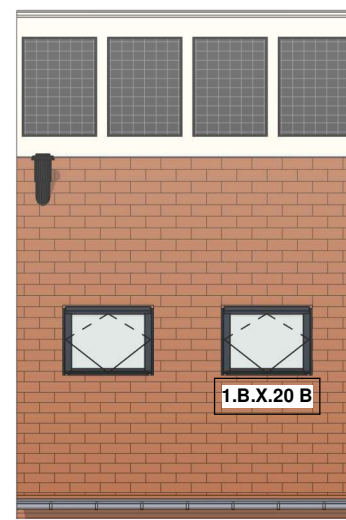

Achtergevel schaal 1:100

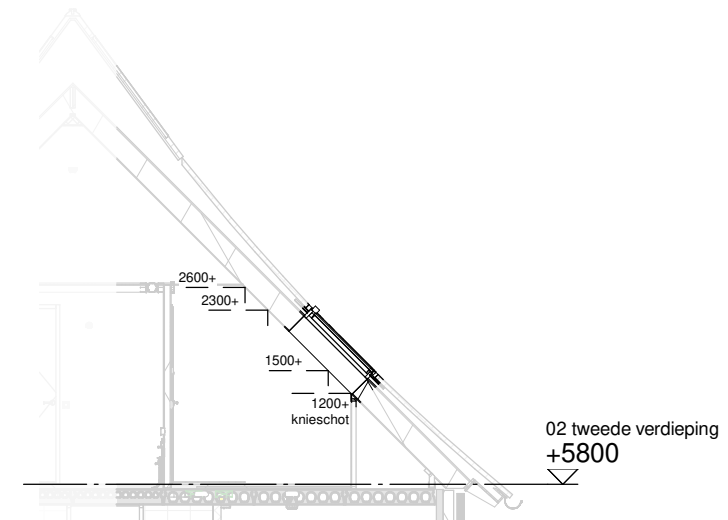

Doorsnede schaal 1:100

**ALLEMAAL
VIELEYAAL**

Optie: Dakramen voor- en achtergevel

Woningtype: Z45

Bouwnummer: -

Optienummer: 1.B.X.20

Schaal: 1:50 / 1:100

Datum: 30-01-2024

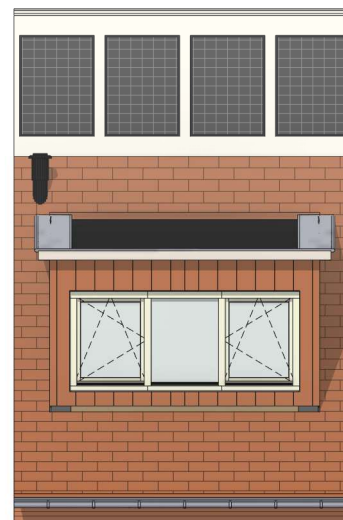
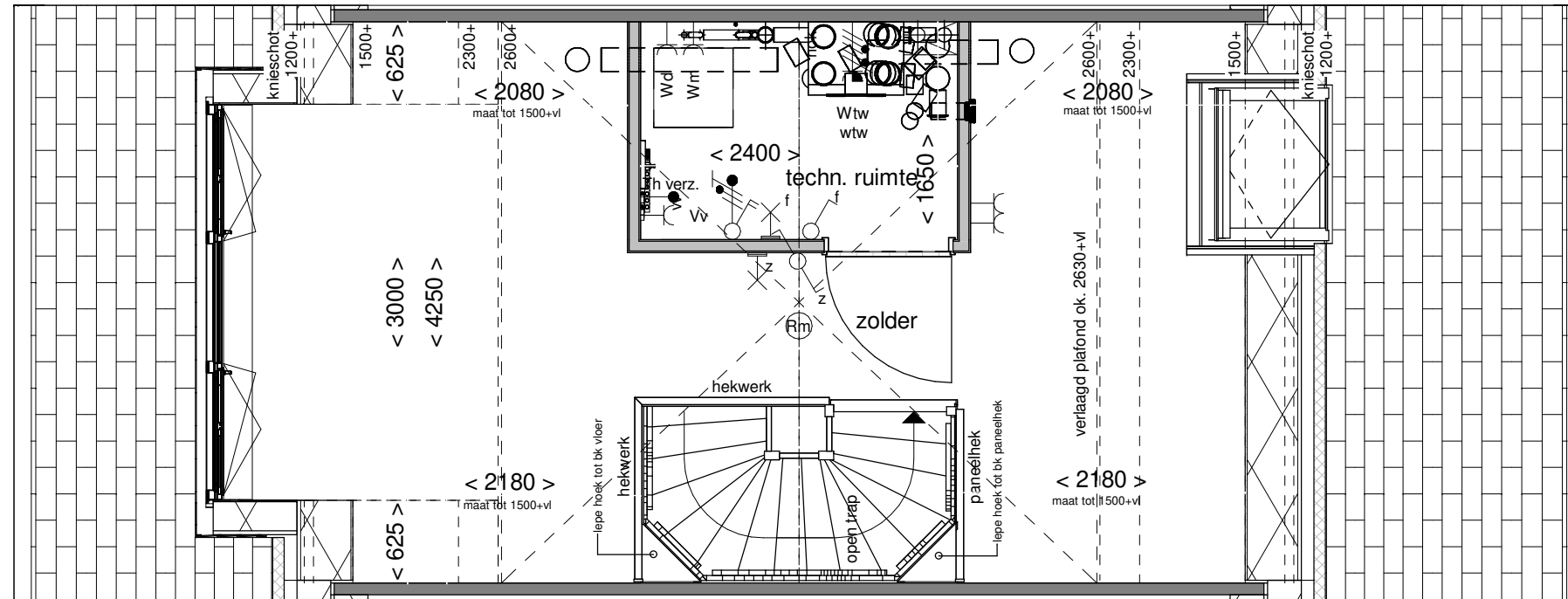

Achtergevel schaal 1:100

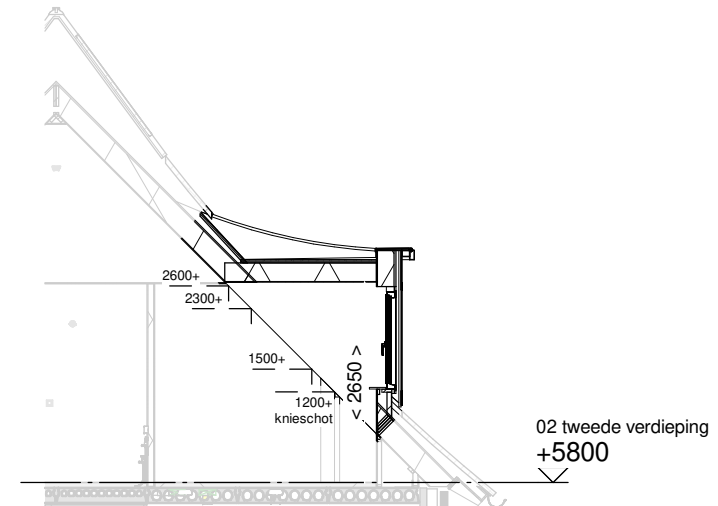

Achtergevel schaal 1:100

**ALLEMAAL
YIELEYAAL**

Optie: Dakkapel
achtergevel 3000mm

Woningtype: Z45

Bouwnummer: -

Optienummer: 1.B.X.34

Schaal: 1:50 / 1:100

Datum: 30-01-2024

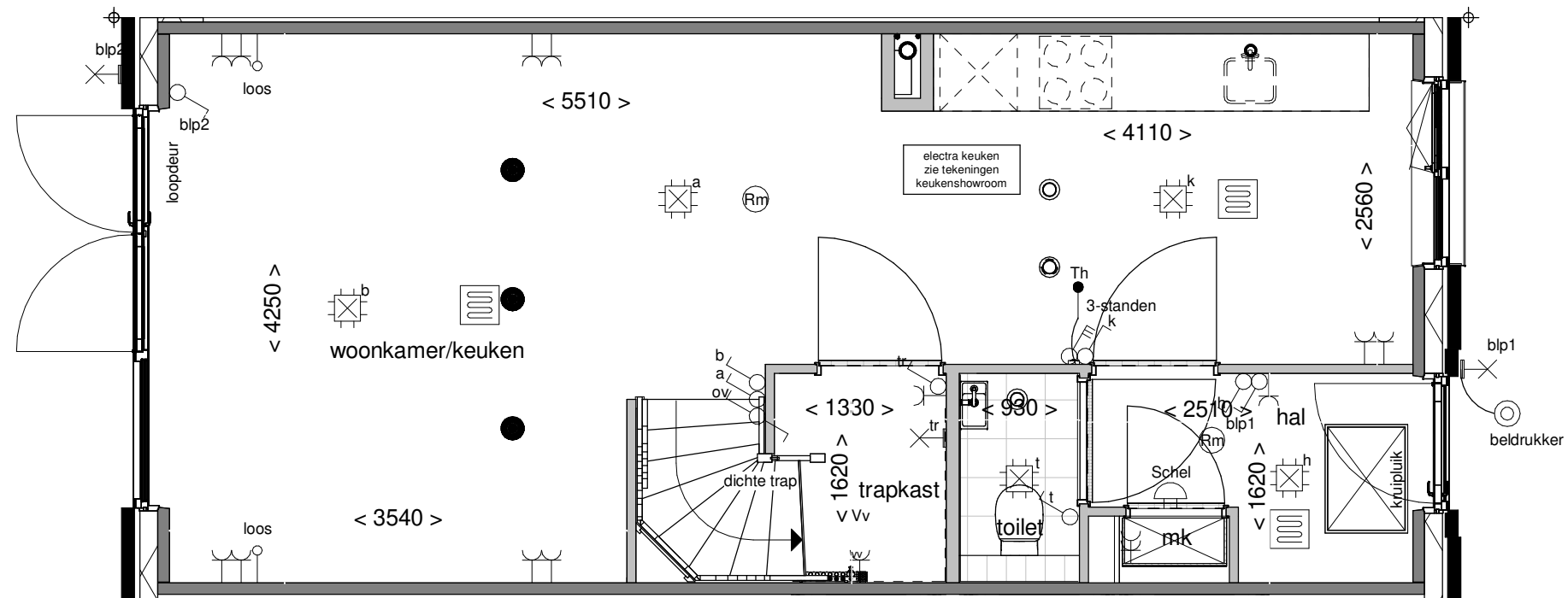

**ALLEMAAL
YIELEYAAL**

Optie: Wand naast trap

Woningtype: Z45

Bouwnummer: -

Optienummer: 1.C.Z.10

Schaal: 1:50

Datum: 30-01-2024

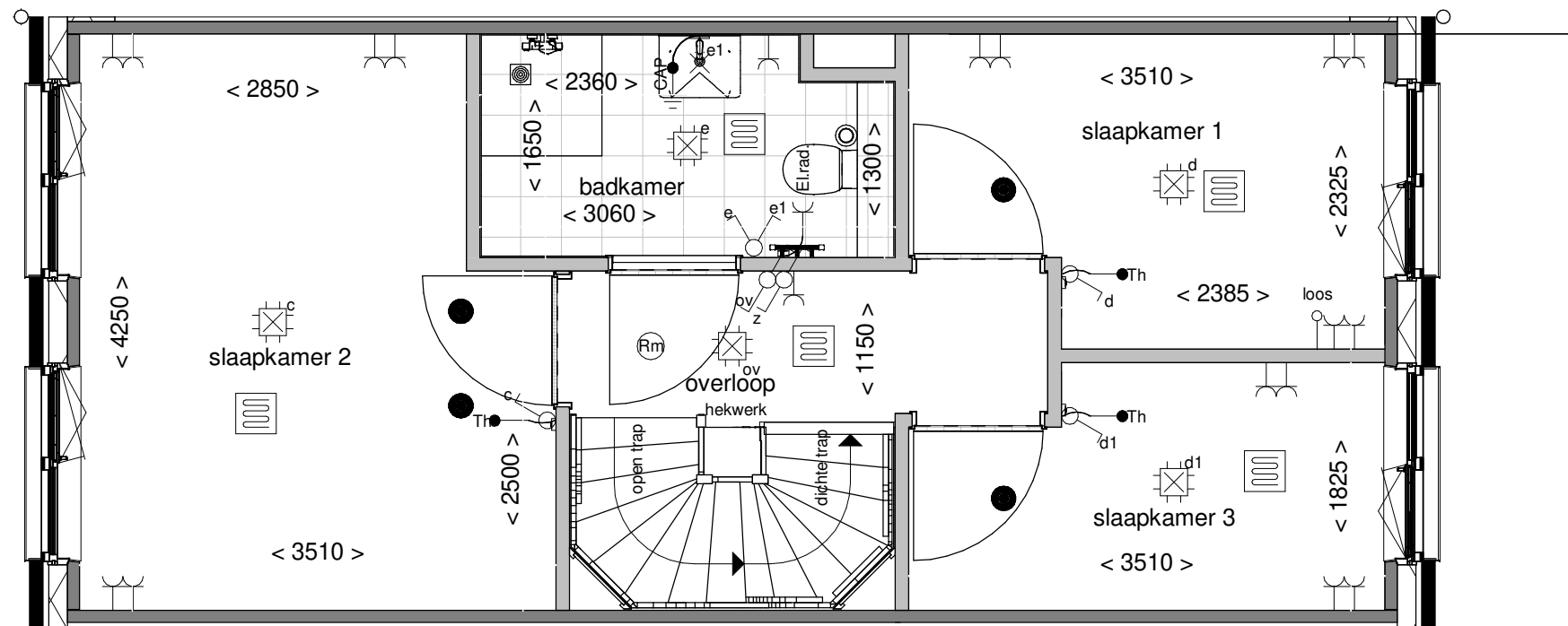

**ALLEMAAL
VIELEYAAL**

Optie: Twee slaapkamers
voorzijde

Woningtype: Z45

Bouwnummer: -

Optienummer: 1.C.Z.36

Schaal: 1:50

Datum: 30-01-2024

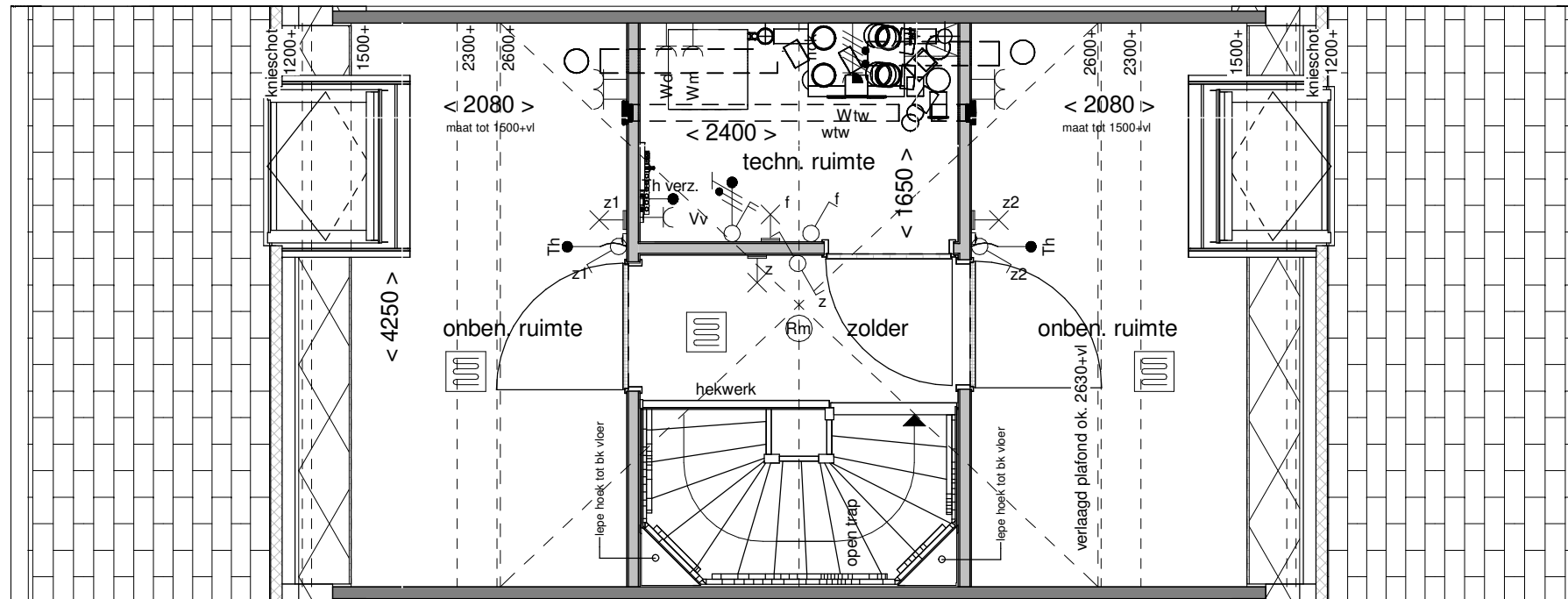

**ALLEMAAL
VIELEYAAL**

Optie: Indeling techn.- en
2 onb. ruimtes

Woningtype: Z45

Bouwnummer: -

Optienummer: 1.C.Z.76

Schaal: 1:50

Datum: 30-01-2024