

**ALLEMAAL  
YIELEYAAL**

Tekening: Situatie Fase 5-6  
 Woningtype: \_\_\_\_\_  
 Bouwnummer: \_\_\_\_\_  
 Bladnummer: VT-S-01  
 Schaal: 1:1000  
 Datum: 30-01-2024



**Renvooi**

- entree woning
- parkeervak eigen terrein
- erfgrens
- struik type n.t.b. koper
- opstelplaats kliko
- tuinhekje
- klinkerbestrating
- betontegels 300x300mm
- groen strook
- haag h=900mm
- haag h=1800mm
- bamboehek h=1800mm
- gaashek met klimplanten en poort h=1600mm
- klimplant

**parkeerplekken en posities bomen en struiken zijn indicatief**













Godschalkstraat

**ALLEMAAL  
YIELEYAAL**

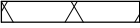

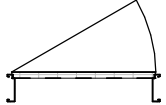
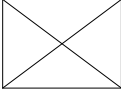



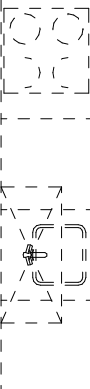





















Tekening:	Situatie Blok K5
Woningtype:	Z
Bouwnummer:	260-264
Bladnummer:	VT-S-08
Schaal:	1:200
Datum:	30-01-2024

bnr: 260 128 m<sup>2</sup>    bnr: 261 100 m<sup>2</sup>    bnr: 262 100 m<sup>2</sup>    bnr: 263 100 m<sup>2</sup>    bnr: 264 132 m<sup>2</sup>

## Renvooi bouwkundig

	metselwerk kleur A
	dakpannen kleur oranje
	entree woning
	metselwerk
	isolatie
	dragende wand
	niet dragende binnenwand
	binnendeurkozijn (met bovenlicht)
	kruipluik
	opstelplaats wasmachine
	opstelplaats wasdroger
	
	principe opstelling keukenblok

## Renvooi installaties

	aansluitpunt licht
	aansluitpunt licht, wand
	centraaldoos met lichtpunt
	armatuur aan de wand
	rookmelder
	aansluitpunt niet bedraad
	verdeelinrichting / meterkast / groepenkast
	beldrukker
	schel
	schakelaar, 1-polig
	werkschakelaar tbv PV-panelen
	schakelaar, 3-polig
	schakelaar, wissel
	schakelaar, kruis
	schakelaar, serie
	wandcontactdoos 1-voudig met beschermingscontact
	wandcontactdoos 2-voudig met beschermingscontact, verticaal
	wandcontactdoos 2-voudig met beschermingscontact
	thermostaatleiding, bedraad
	mechanische ventilatie-unit incl. warmteterugwinunit
	warmtepomp
	inblaasventiel mechanische ventilatie
	afzuigventiel mechanische ventilatie
	verdelers vloerverwarming
	Afleverzet stadswarmte
	ruimte voorzien van vloerverwarming
	elektrische radiator
	kanalen in het zicht

### Disclaimer

De op deze tekeningen aangegeven maten zijn circa maten in millimeters en tussen de wanden / vloeren gemeten, waarbij geen rekening is gehouden met enige wandafwerking, plinten, aftimmering, ect. In verband met de nauwkeurige uitwerking van details, constructie, maatvoering, materialen e.d. kunnen er kleine afwijkingen ontstaan ten opzichte van de nu vermelde gegevens. Deze geringe afwijkingen geven geen aanleiding tot verrekening. Aan de op deze tekening aangegeven maten kunnen derhalve geen rechten worden ontleend. De op deze tekeningen aangegeven maatvoering is niet geschikt voor opdrachten aan derden door koper(s). De posities van aansluitingen en installatie onderdelen zijn indicatief op tekening aangegeven. De exacte aantallen en posities zullen na berekening in het werk door de installateurs worden bepaald en kunnen afwijken van deze tekening.

**ALLEMAAL  
YIELEYAAL**

Tekening: Renvooi

Woningtype: -

Bouwnummer: -

Bladnummer: VT-0-00c

Schaal: -

Datum: 30-01-2024



Type: Z  
bwnr: 260

Type: Z  
bwnr: 261

Type: Z  
bwnr: 262

Type: Z  
bwnr: 263

Type: Z  
bwnr: 264

Voorgevel



Type: Z  
bwnr: 264

Type: Z  
bwnr: 263

Type: Z  
bwnr: 262

Type: Z  
bwnr: 261

Type: Z  
bwnr: 260

Achtergevel

ALLEMAAL  
YYIELEYAAL

Tekening: Gevels blok K5

Woningtype: Z

Bouwnummer: 260 t/m 264

Bladnummer: VT-K5-00a

Schaal: 1:150

Datum: 30-01-2024

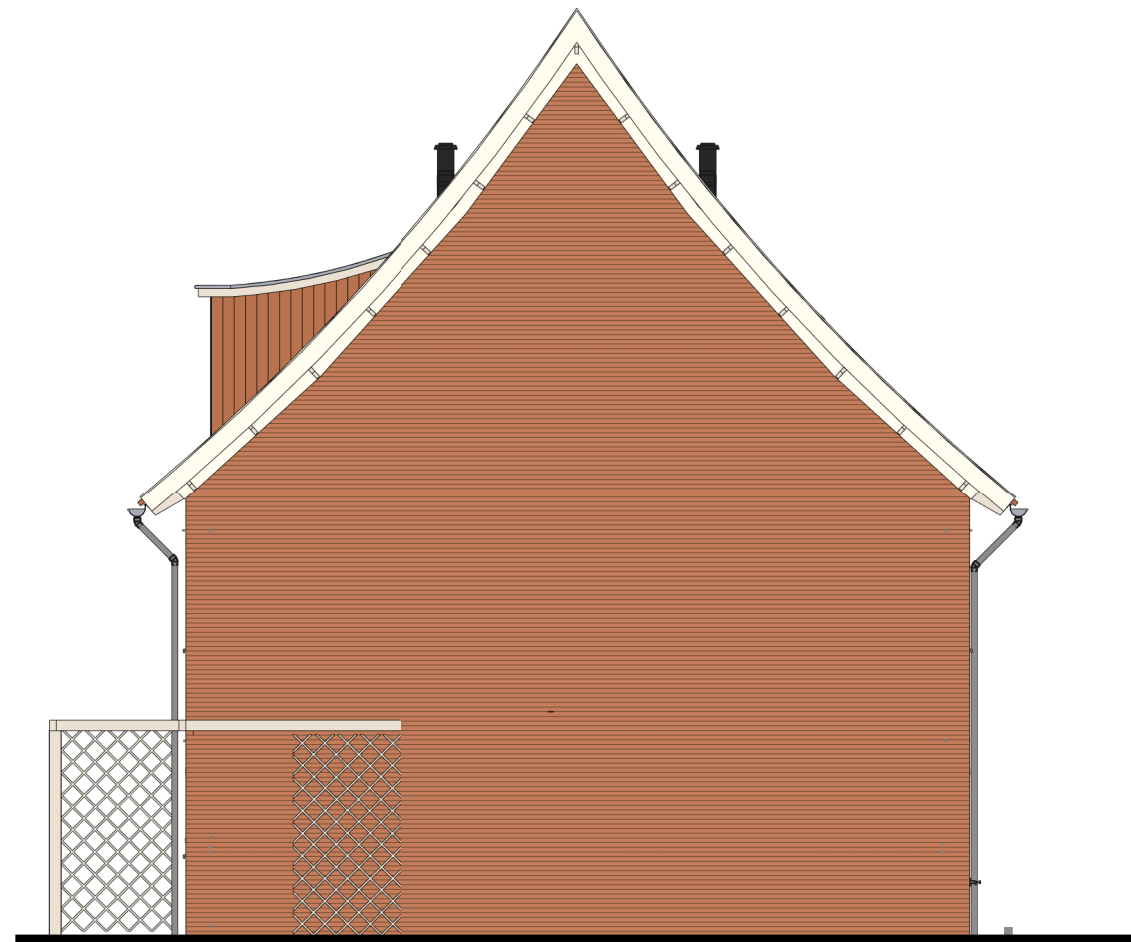

Rechter zijgevel

Type: Z  
bwnr: 264

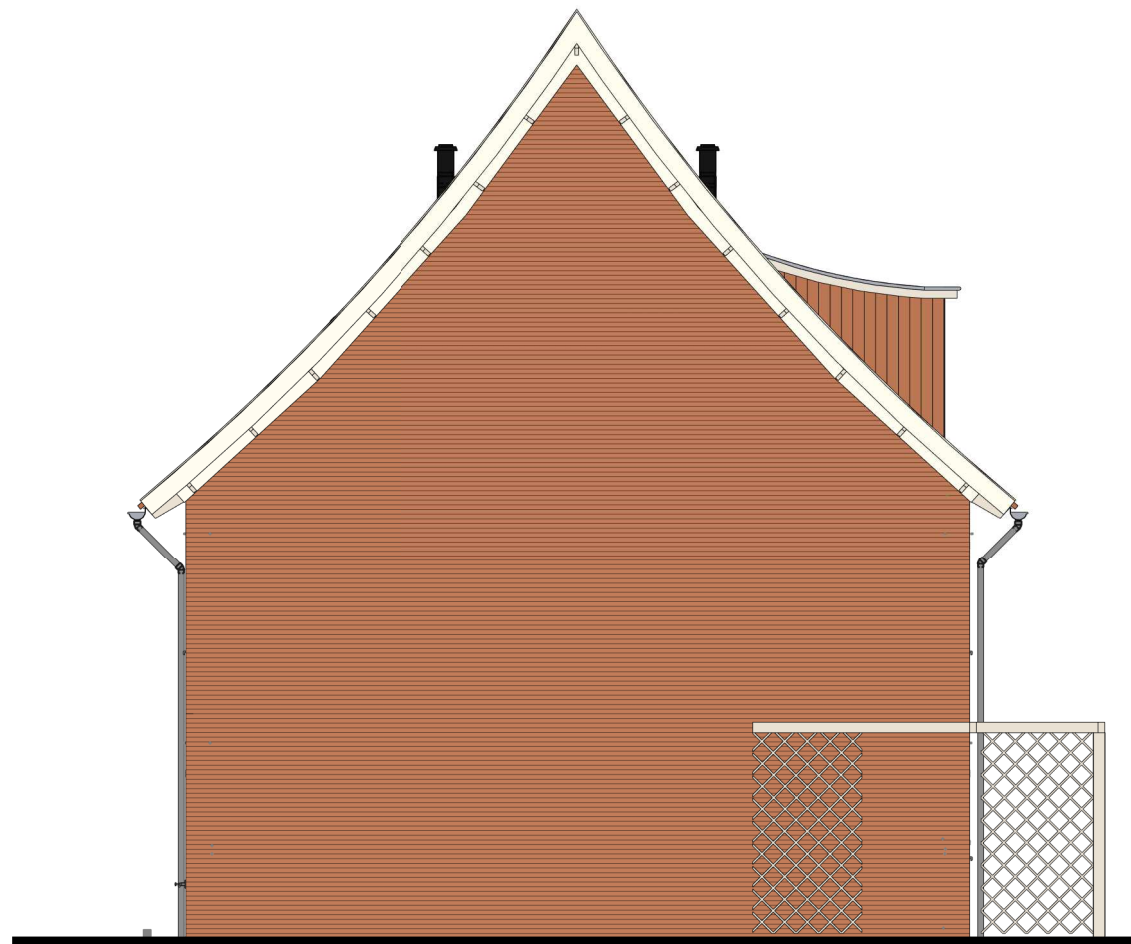

Linker zijgevel

Type: Z  
bwnr: 260

ALLEMAAL  
YIELEYAAL

Tekening: Zijgevels blok K5

Woningtype: Z

Bouwnummer: 260 t/m 264

Bladnummer: VT-K5-00b

Schaal: 1:100

Datum: 30-01-2024

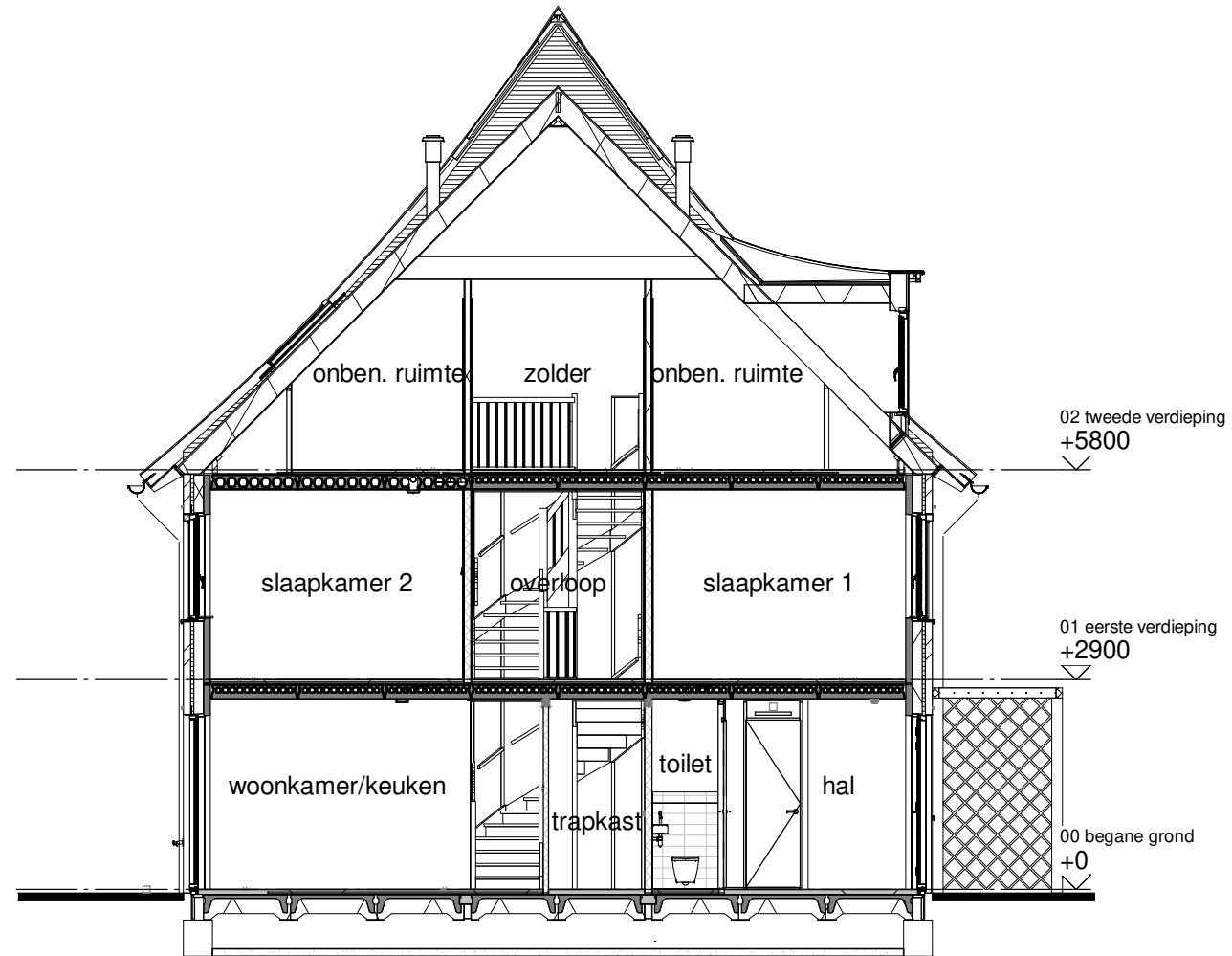

Type: Z  
bwnr: 260

Doorsnede A

ALLEMAAL  
VIELEVAAL

Tekening: Doorsnede Blok K5

Woningtype: Z

Bouwnummer: 260

Bladnummer: VT-K5-00c

Schaal: 1:100

Datum: 30-01-2024

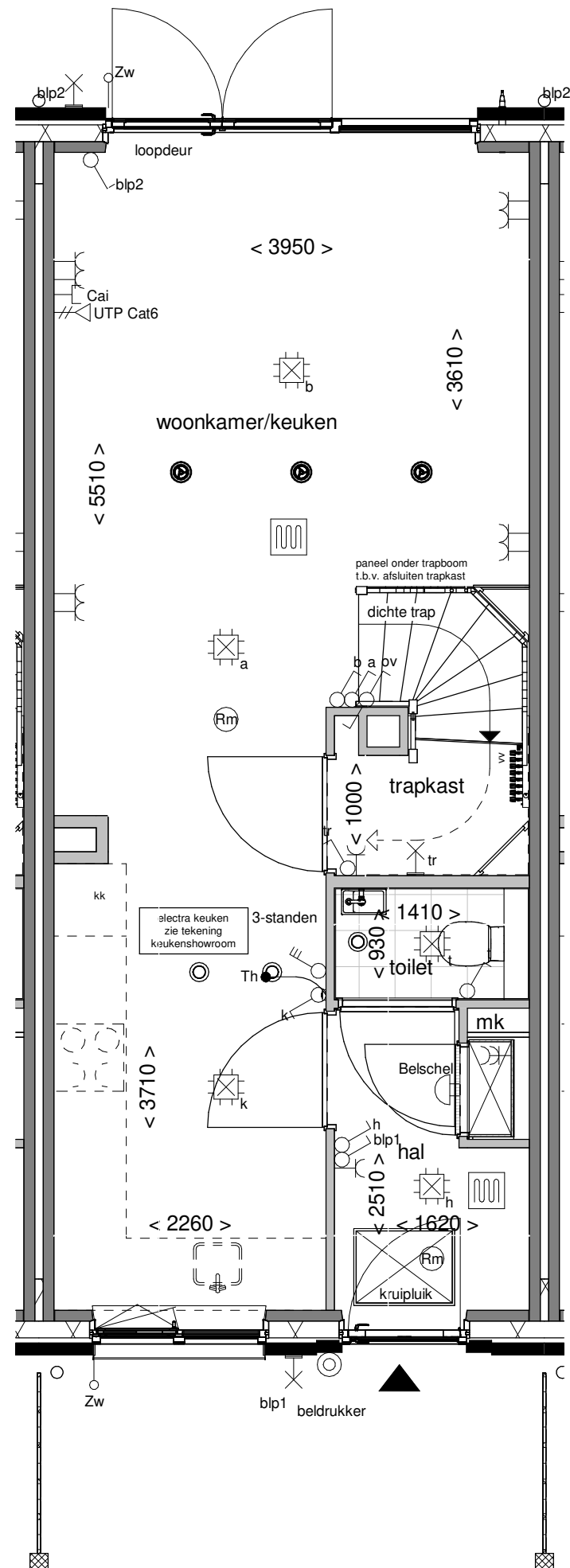

**ALLEMAAL  
VIELEVAAL**

Tekening: Begane grond  
 Woningtype: Z  
 Bouwnummer: 262  
 Bladnummer: VT-K5-262a  
 Schaal: 1:50  
 Datum: 30-01-2024

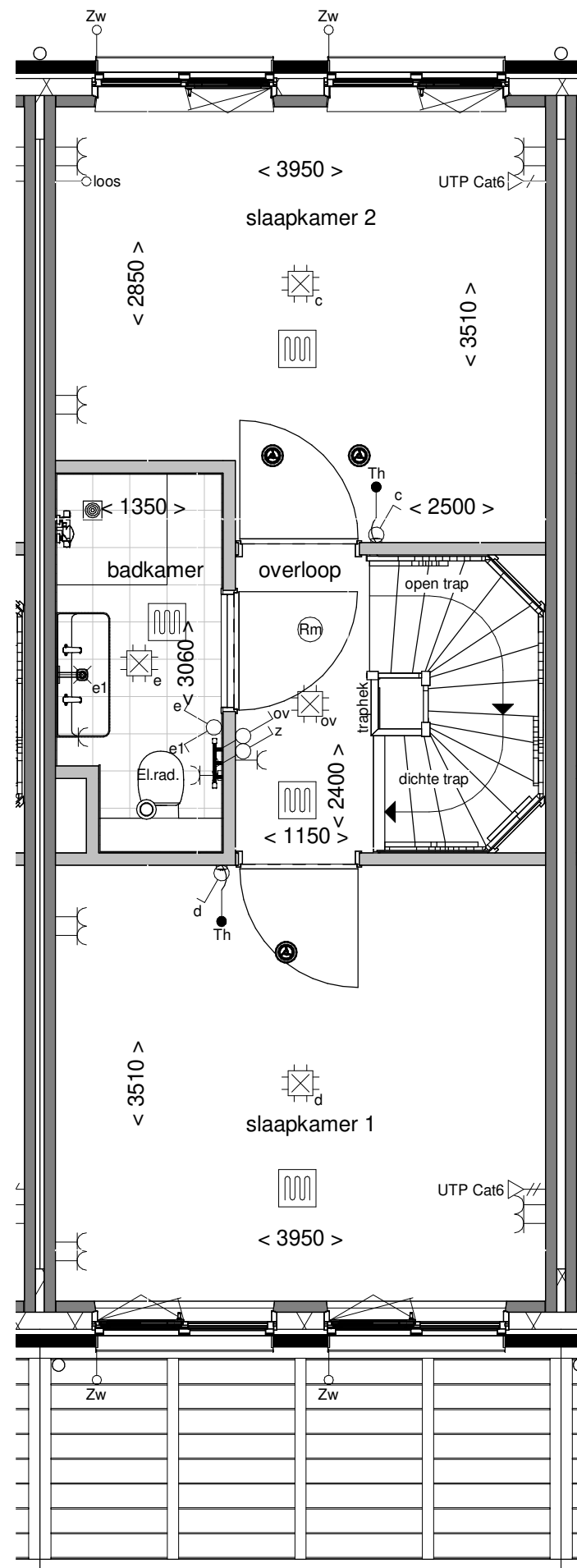

**ALLEMAAL  
VIELEJAAL**

Tekening:	Eerste verdieping
Woningtype:	Z
Bouwnummer:	262
Bladnummer:	VT-K5-262b
Schaal:	1:50
Datum:	30-01-2024



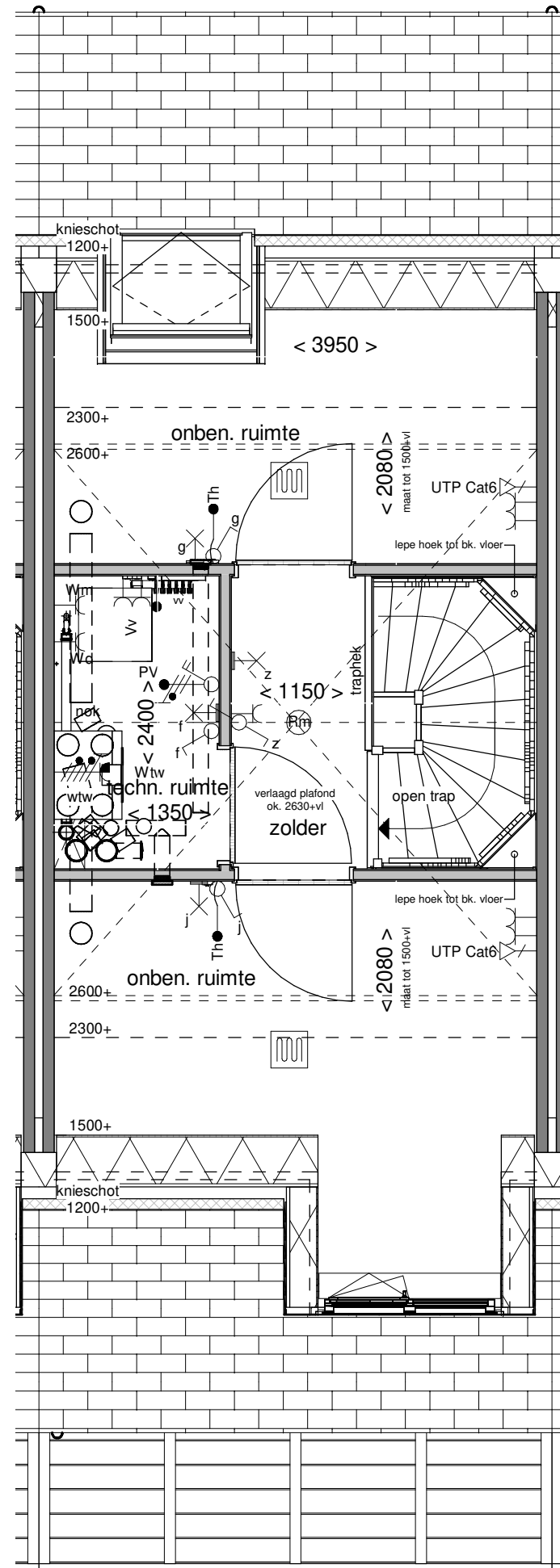

**ALLEMAAL  
VIELEJAAL**

Tekening: Tweede verdieping

Woningtype: Z

Bouwnummer: 262

Bladnummer: VT-K5-262c

Schaal: 1:50

Datum: 30-01-2024



Voorgevel

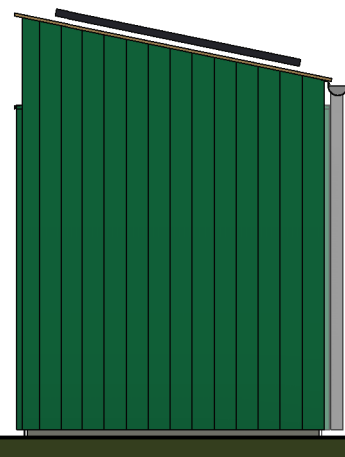

Linker zijgevel

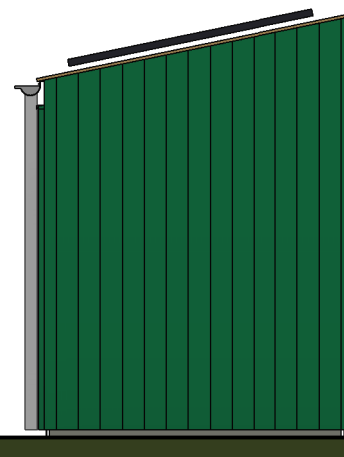

Rechter zijgevel

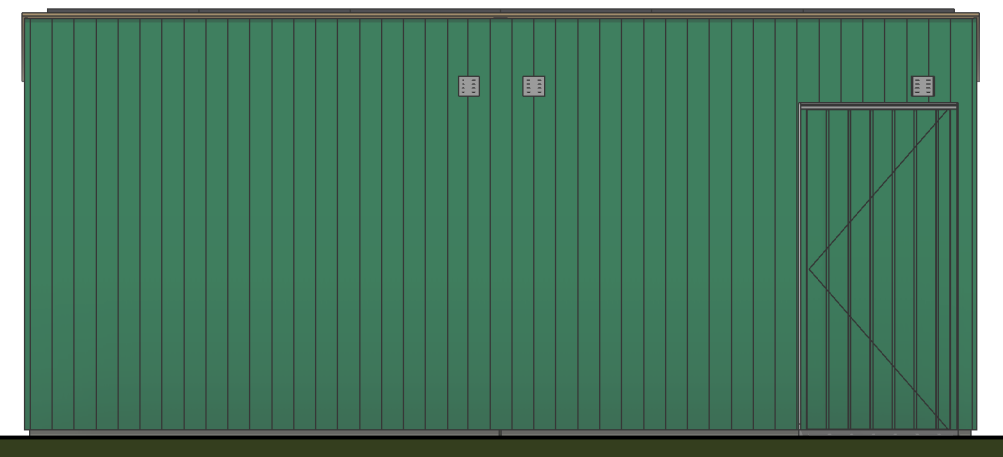

Achtergevel

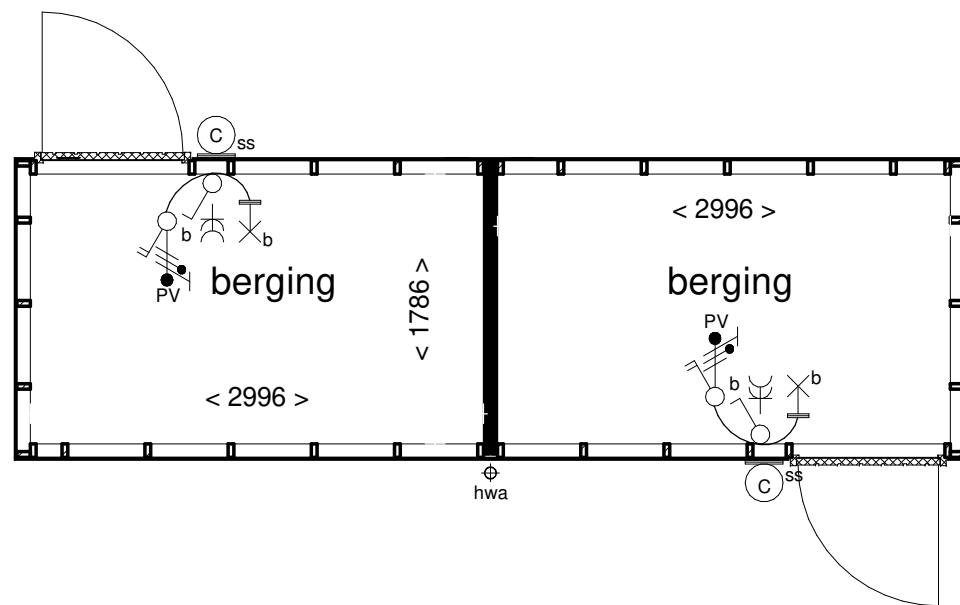

Begane grond

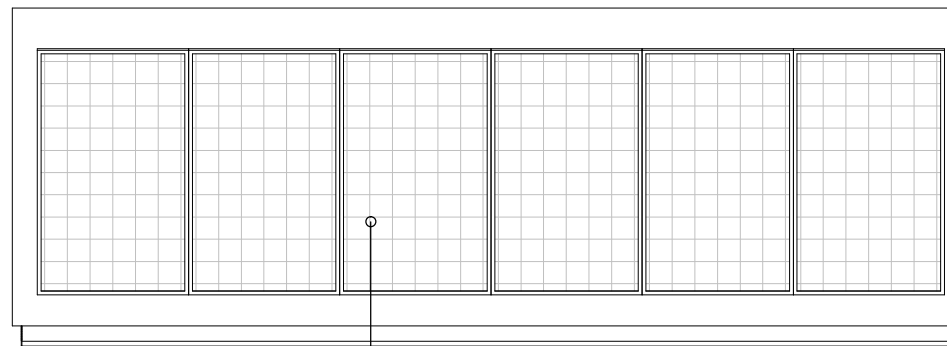

Dakaanzicht

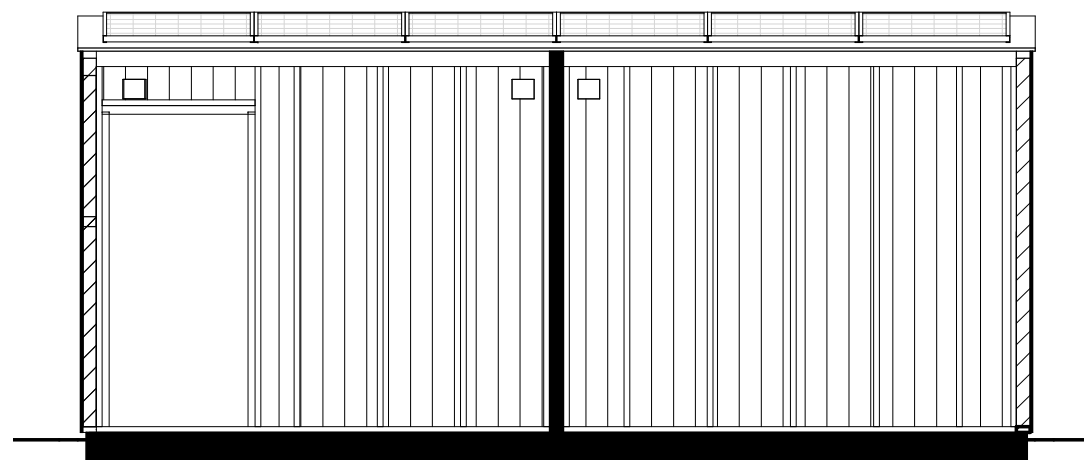

Doorsnede A-A

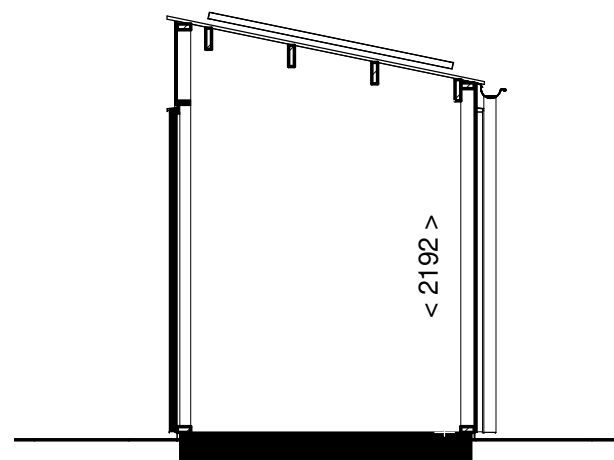

Doorsnede B-B

**Als getekend:**

- bnr. 236 - 237
- bnr. 238 - 239
- bnr. 240 - 241
- bnr. 242 - 243
- bnr. 272 - 273
- bnr. 274 - 275
- bnr. 276 - 277
- bnr. 278 - 279
- bnr. 280 - 281
- bnr. 282 - 283
- bnr. 284 - 285
- bnr. 286 - 287
- bnr. 288 - 289
- bnr. 290 - 291
- bnr. 292 - 293

**Gespiegeld:**

- bnr. 261 - 262
- bnr. 263 - 264
- bnr. 296 - 297
- bnr. 298 - 299

**ALLEMAAL  
YIELEYAAL**

Tekening: **Berging A**

Woningtype: -

Bouwnummer:

Bladnummer: **VT-BE01**

Schaal: **1:50**

Datum: **30-01-2024**

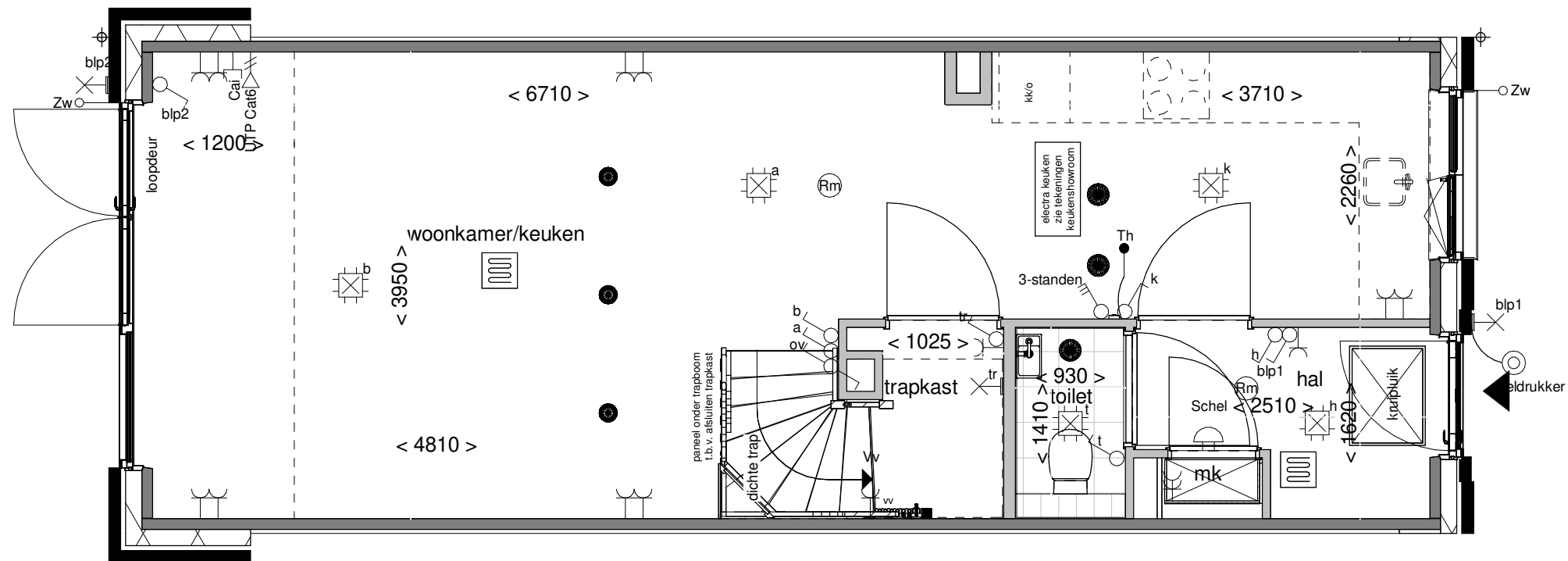

Achtergevel schaal 1:100

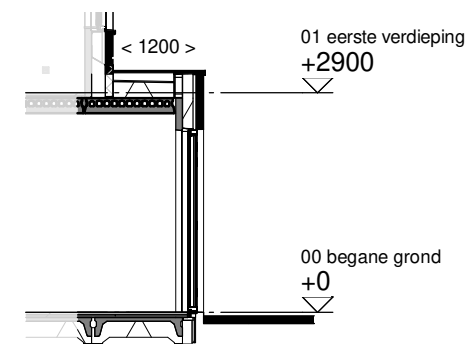

Doorsnede schaal 1:100

**ALLEMAAL  
VIELEYAAL**

Optie: **Uitbouw achtergevel  
1200mm**

Woningtype: **Z42**

Bouwnummer: -

Optienummer: **0.A.Z.16**

Schaal: **1:50 / 1:100**

Datum: **30-01-2024**

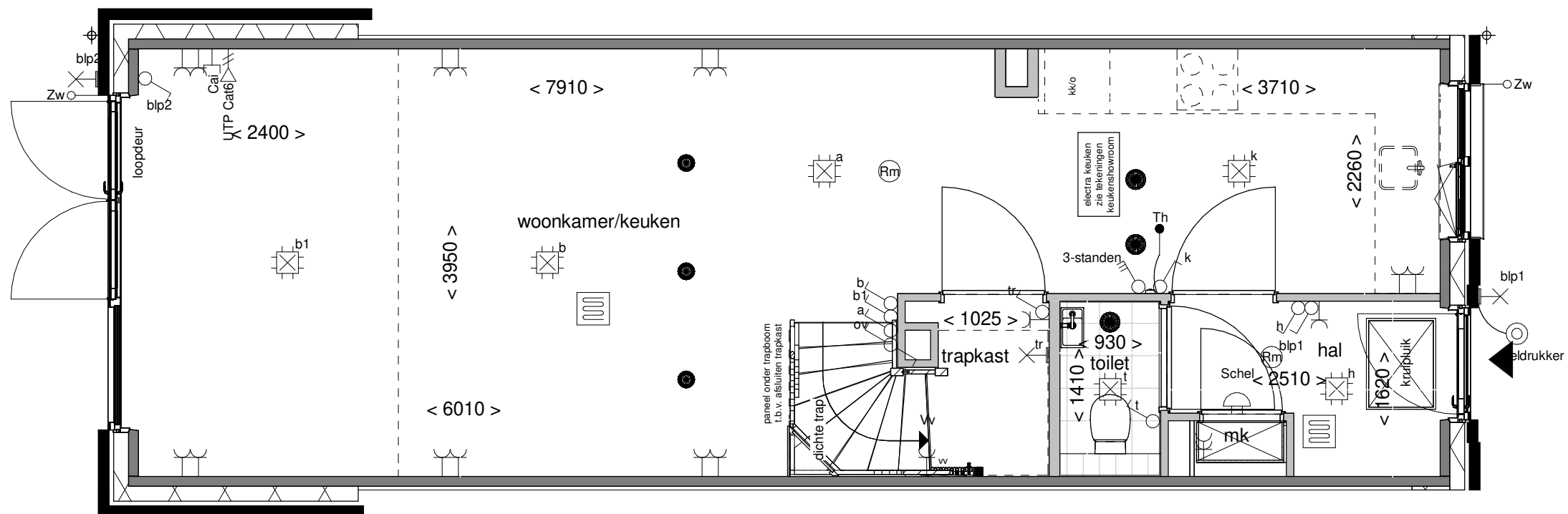

Achtergevel schaal 1:100

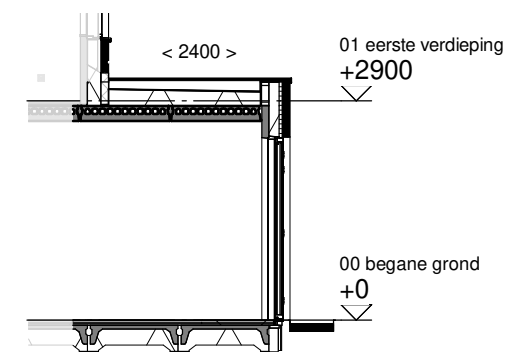

Doorsnede schaal 1:100

**ALLEMAAL  
YIELEYAAL**

Optie: **Uitbouw achtergevel  
2400mm**

Woningtype: **Z42**

Bouwnummer: -

Optienummer: **0.A.Z.36**

Schaal: **1:50 / 1:100**

Datum: **30-01-2024**

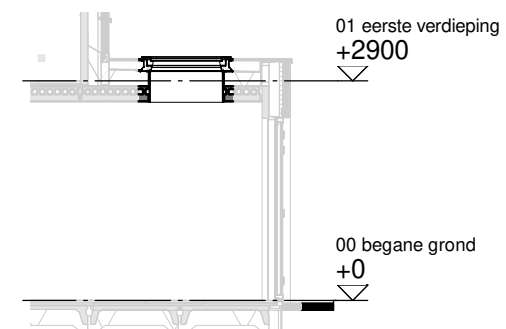
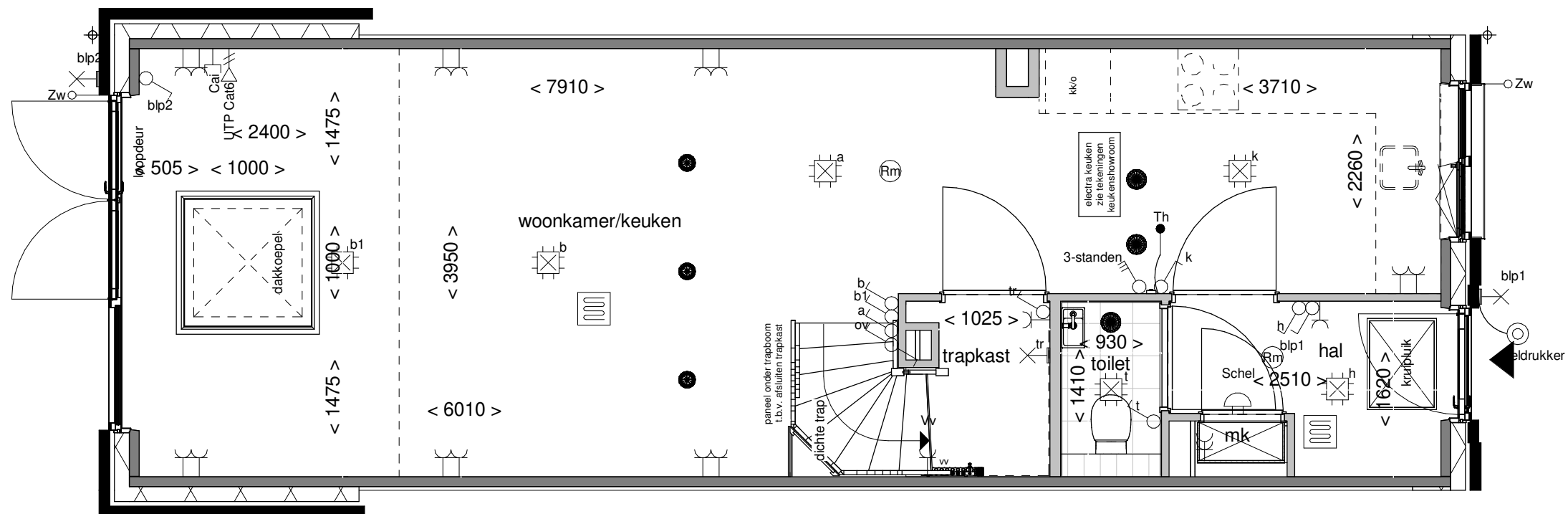

Doorsnede schaal 1:100

**ALLEMAAL  
VIELEYAAL**

Optie: Lichtkoepel in  
uitbouw 2400mm

Woningtype: Z42

Bouwnummer: -

Optienummer: 1.B.X.10

Schaal: 1:50 / 1:100

Datum: 30-01-2024

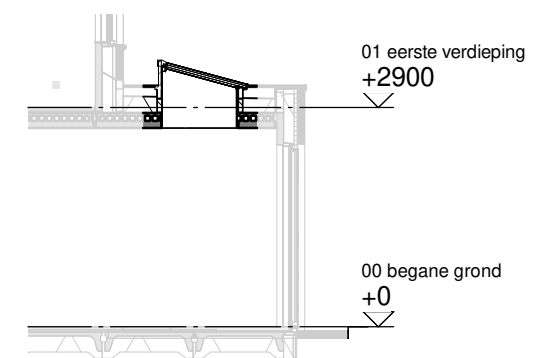
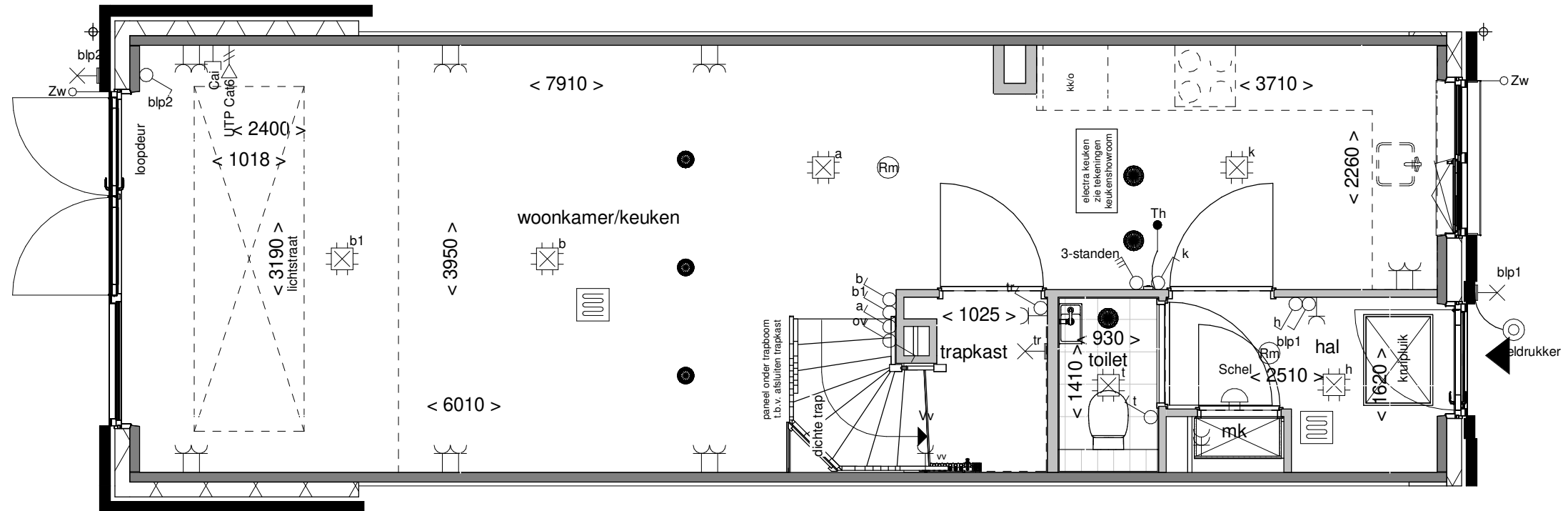

Doorsnede schaal 1:100

**ALLEMAAL  
VIELEYAAL**

Optie: Lichtstraat in uitbouw  
2400mm

Woningtype: Z42

Bouwnummer: -

Optienummer: 1.B.X.14

Schaal: 1:50 / 1:100

Datum: 30-01-2024

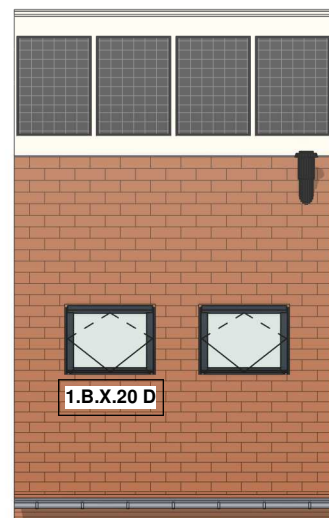
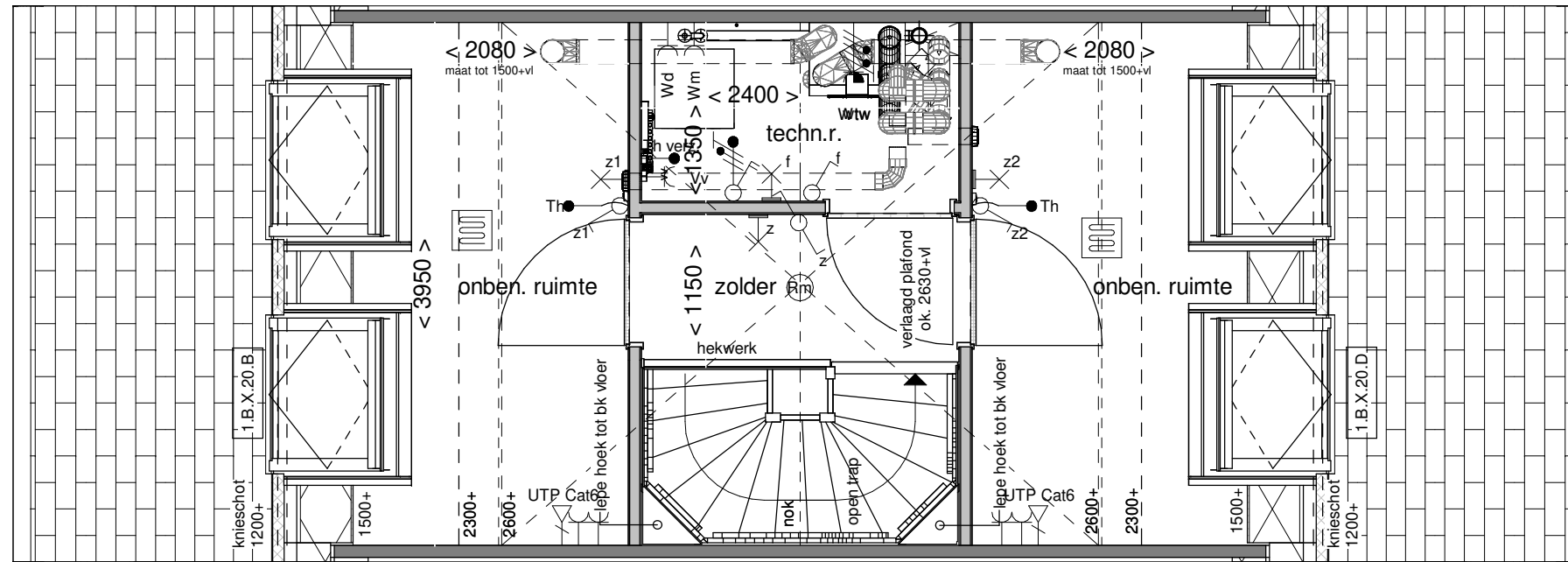

Voorgevel schaal 1:100

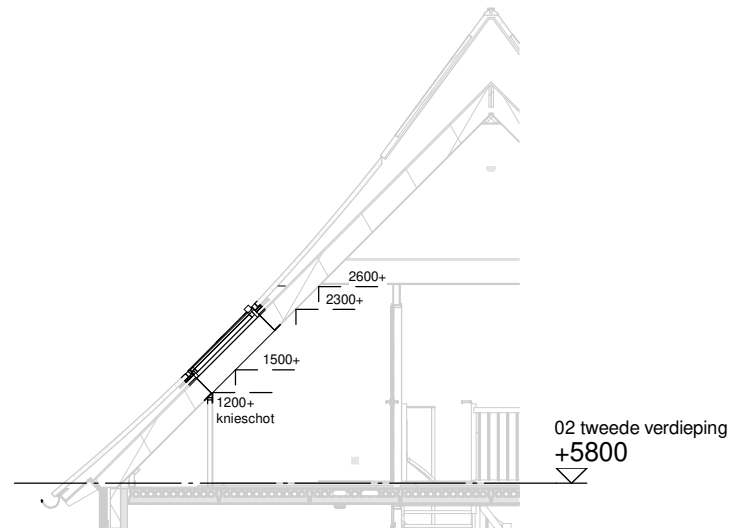

Doorsnede schaal 1:100

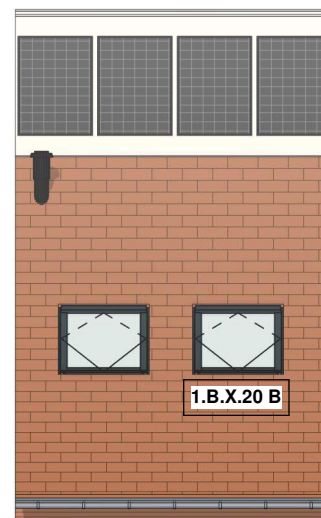

Achtergevel schaal 1:100

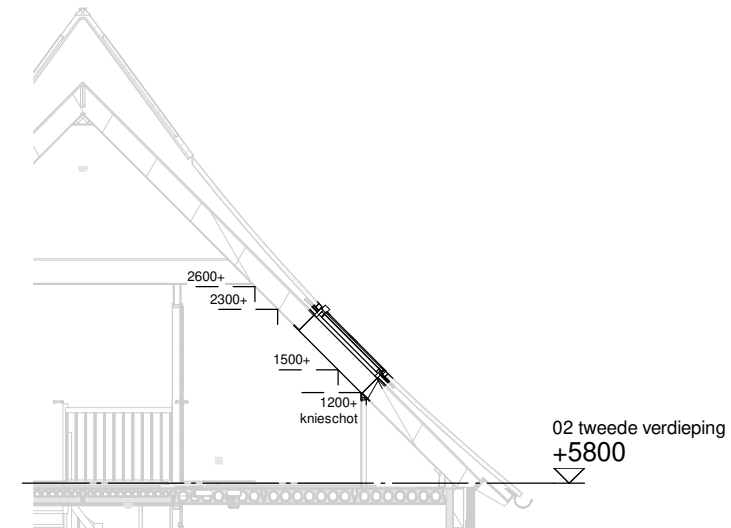

Doorsnede schaal 1:100

ALLEMAAL  
YIELEYAAL

Optie: Dakramen voor- en achtergevel

Woningtype: Z42

Bouwnummer: -

Optienummer: 1.B.X.20

Schaal: 1:50 / 1:100

Datum: 30-01-2024

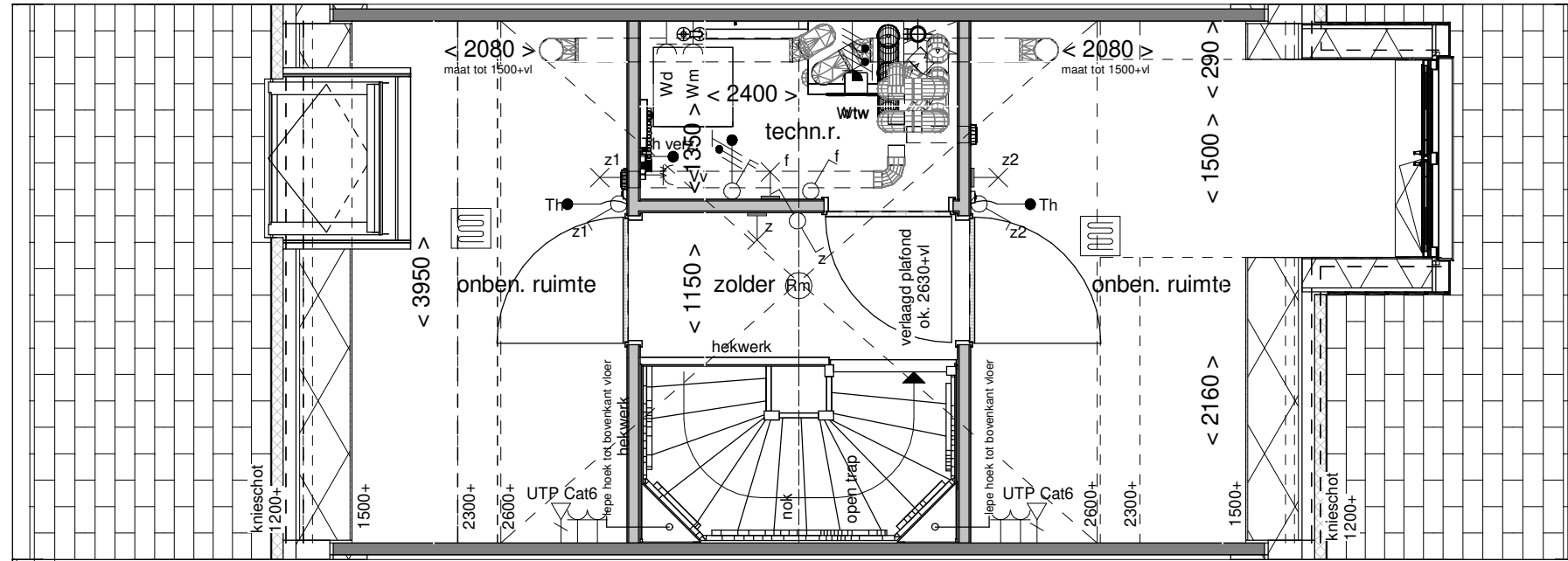

Voorgevel schaal 1:100

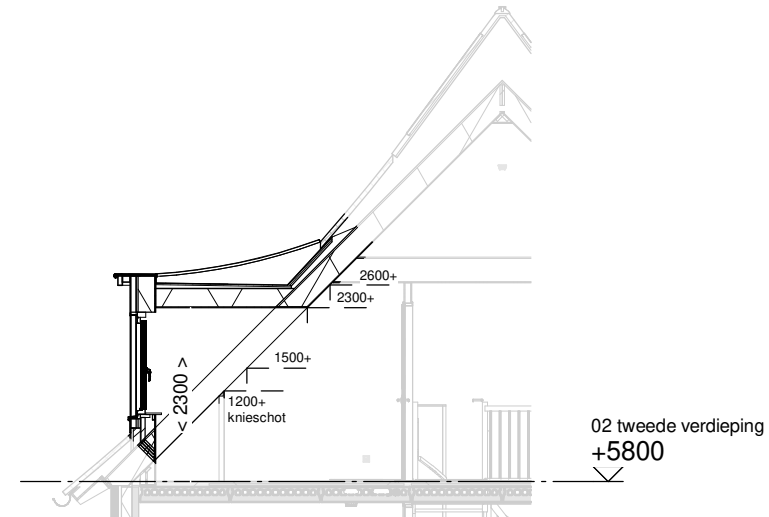

Doorsnede schaal 1:100

**ALLEMAAL  
YIELEYAAL**

Optie: Dakkapel  
voorgevel 1500mm

Woningtype: Z42

Bouwnummer: -

Optienummer: 1.B.X.33

Schaal: 1:50 / 1:100

Datum: 30-01-2024



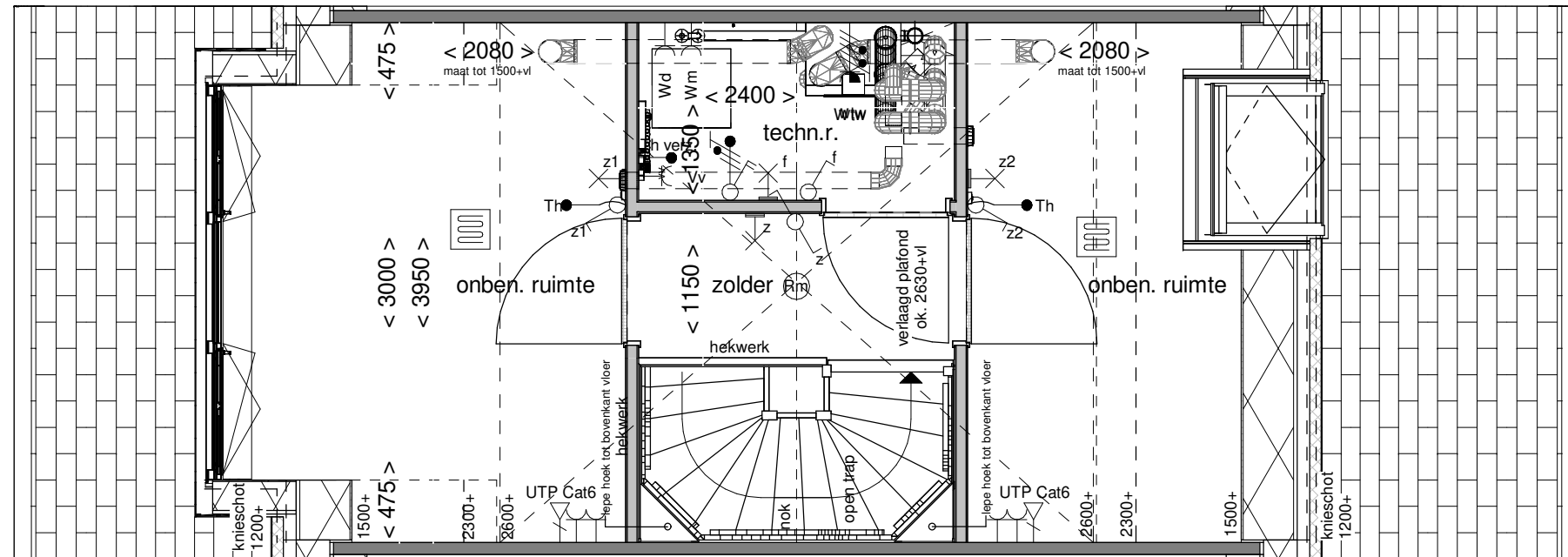

Achtergevel schaal 1:100

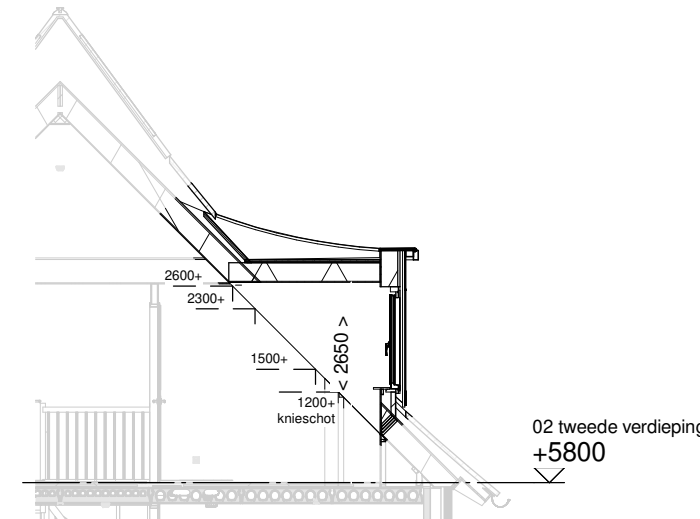

Doorsnede schaal 1:100

**ALLEMAAL  
YIELEYAAL**

Optie: Dakkapel  
achtergevel 3000mm

Woningtype: Z42

Bouwnummer: -

Optienummer: 1.B.X.34

Schaal: 1:50 / 1:100

Datum: 30-01-2024

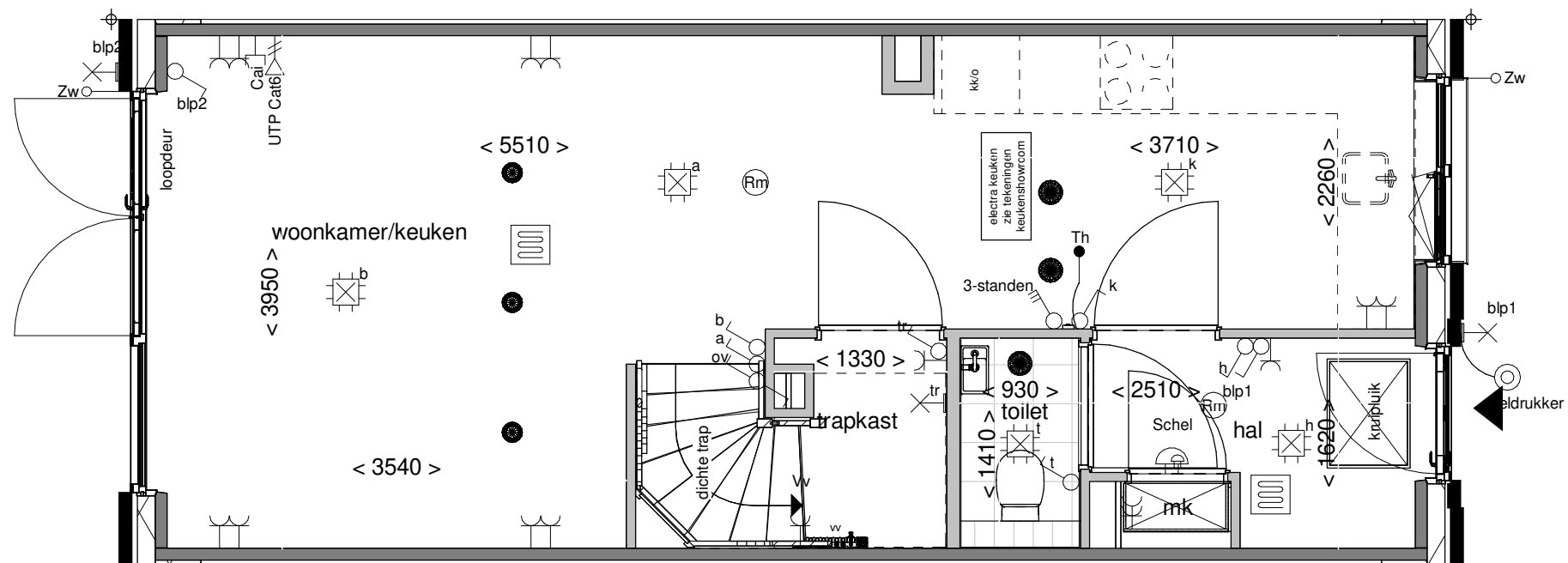

**ALLEMAAL  
VIELEYAAL**

Optie: Wand naast trap

Woningtype: Z42

Bouwnummer: -

Optienummer: 1.C.Z.10

Schaal: 1:50

Datum: 30-01-2024