

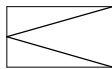

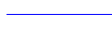







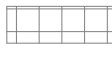

**ALLEMAAL  
YIELEYAAL**

Tekening: Situatie Fase 5-6  
 Woningtype: \_\_\_\_\_  
 Bouwnummer: \_\_\_\_\_  
 Bladnummer: VT-S-01  
 Schaal: 1:1000  
 Datum: 17-06-2024

# Renvooi

-  - entree woning
-  - parkeervak eigen terrein
-  - erfgrans
-  - struik type n.t.b. koper
-  - opstelplaats kliko
-  - tuinhekje
-  - klinkerbestrating
-  - betontegels 300x300mm
-  - groen strook
-  - haag h=900mm
-  - haag h=1800mm
-  - bamboehek h=1800mm
-  - gaashek met klimplanten en poort h=1600mm
-  - klimplant
-  - Slagboom met kast type ntb
-  - Straatverlichting

parkeerplekken en posities bomen, struiken en straatverlichting zijn indicatief



Slagboom met kast type ntb; aangesloten op elektra/data in mantelbuis hoekwoning

**ALLEMAAL  
YIELEYAAL**

Tekening: Situatie Blok J2

---

Woningtype: Z45

---

Bouwnummer: 219-226

---

Bladnummer: VT-S-13









---

Schaal: 1:200



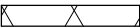

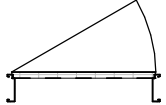
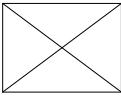
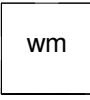

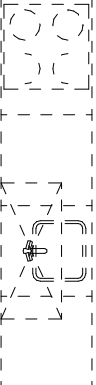





















---

Datum: 17-06-2024

## Renvooi bouwkundig

	metselwerk kleur A
	dakpannen kleur oranje
	entree woning
	metselwerk
	isolatie
	dragende wand
	niet dragende binnenwand
	binnendeurkozijn (met bovenlicht)
	kruipluik
	opstelplaats wasmachine
	opstelplaats wasdroger
	
	principe opstelling keukenblok

## Renvooi installaties

	aansluitpunt licht
	aansluitpunt licht, wand
	centraaldoos met lichtpunt
	armatuur aan de wand
	rookmelder
	aansluitpunt niet bedraad
	verdeelinrichting / meterkast / groepenkast
	beldrukker
	schel
	schakelaar, 1-polig
	werkschakelaar tbv PV-panelen
	schakelaar, 3-polig
	schakelaar, wissel
	schakelaar, kruis
	schakelaar, serie
	wandcontactdoos 1-voudig met beschermingscontact
	wandcontactdoos 2-voudig met beschermingscontact, verticaal
	wandcontactdoos 2-voudig met beschermingscontact
	thermostaatleiding, bedraad
	mechanische ventilatie-unit incl. warmteterugwinunit
	warmtepomp
	inblaasventiel mechanische ventilatie
	uitblaasventiel mechanische ventilatie
	verdeler vloerverwarming
	Afleverzet stadswarmte
	ruimte voorzien van vloerverwarming
	elektrische radiator
	kanalen in het zicht

### Disclaimer

De op deze tekeningen aangegeven maten zijn circa maten in millimeters en tussen de wanden / vloeren gemeten, waarbij geen rekening is gehouden met enige wandafwerking, plinten, aftimmering, ect. In verband met de nauwkeurige uitwerking van details, constructie, maatvoering, materialen e.d. kunnen er kleine afwijkingen ontstaan ten opzichte van de nu vermelde gegevens. Deze geringe afwijkingen geven geen aanleiding tot verrekening. Aan de op deze tekening aangegeven maten kunnen derhalve geen rechten worden ontleend. De op deze tekeningen aangegeven maatvoering is niet geschikt voor opdrachten aan derden door koper(s). De posities van aansluitingen en installatie onderdelen zijn indicatief op tekening aangegeven. De exacte aantallen en posities zullen na berekening in het werk door de installateurs worden bepaald en kunnen afwijken van deze tekening.

**ALLEMAAL  
YIELEYAAL**

Tekening: Renvooi

Woningtype: -

Bouwnummer: -

Bladnummer: VT-0-00c

Schaal: -

Datum: 19-10-2023



Type: Z45  
bwnr: 226

Type: Z45  
bwnr: 225

Type: Z45  
bwnr: 224

Type: Z45  
bwnr: 223

Type: Z45  
bwnr: 222

Type: Z45  
bwnr: 221

Type: Z45  
bwnr: 220

Type: Z45  
bwnr: 219

Vorgevel

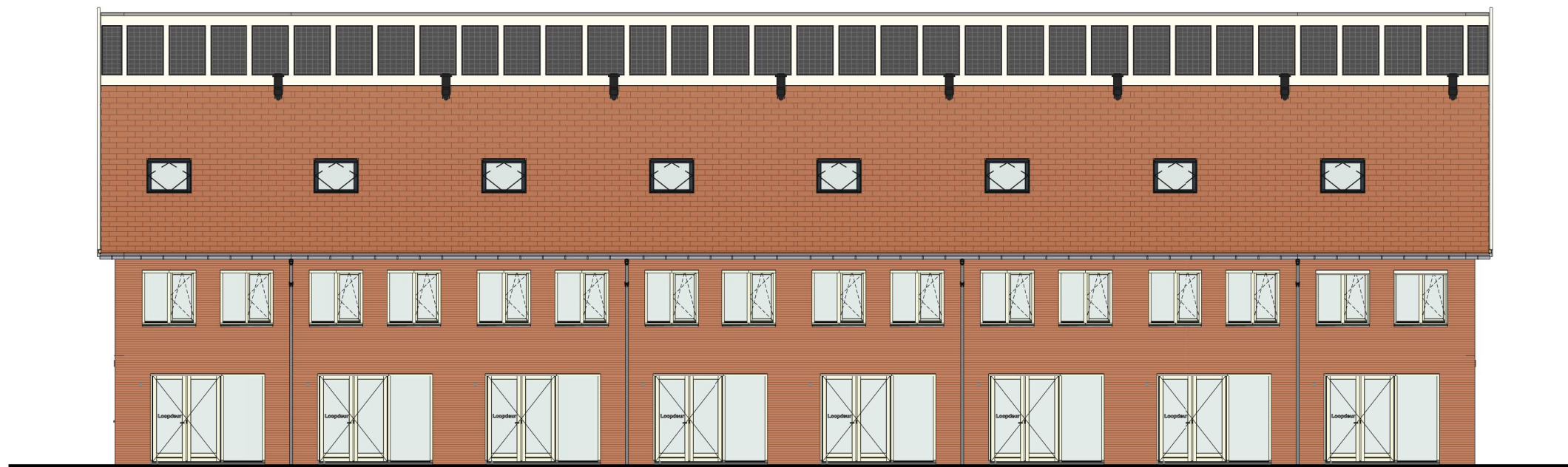

Type: Z45  
bwnr: 219

Type: Z45  
bwnr: 220

Type: Z45  
bwnr: 221

Type: Z45  
bwnr: 222

Type: Z45  
bwnr: 223

Type: Z45  
bwnr: 224

Type: Z45  
bwnr: 225

Type: Z45  
bwnr: 226

Achtergevel

ALLEMAAL  
YIELEYAAL

Tekening: Gevels blok J2

Woningtype: Z45

Bouwnummer: 219 t/m 226

Bladnummer: VT-J2-00a

Schaal: 1:150

Datum: 30-01-2024

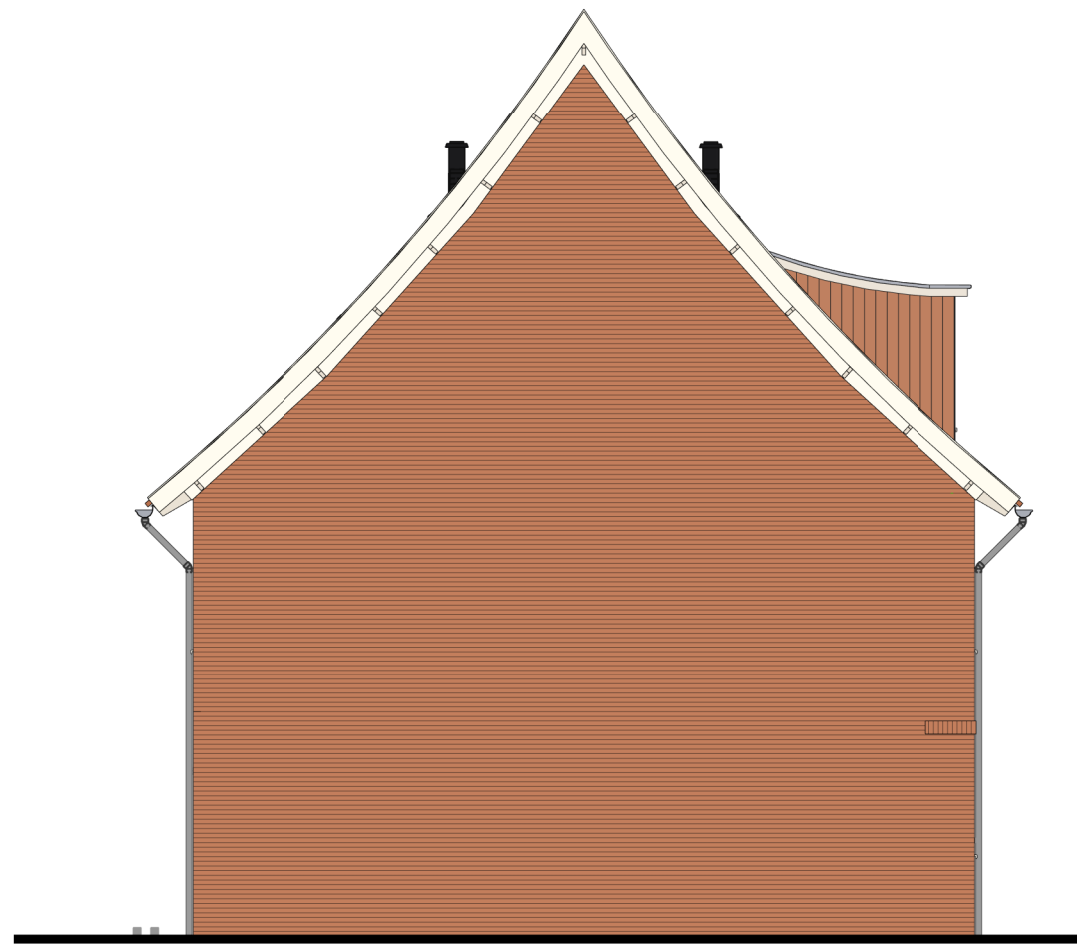

Type: Z45  
Bouwnummer: 226

Linker zijgevel



Type: Z45  
Bouwnummer: 219

Rechter zijgevel

ALLEMAAL  
YIELEYAAL

Tekening: Zijgevels blok J2

Woningtype: Z45

Bouwnummer: 219 t/m 226

Bladnummer: VT-J2-00b

Schaal: 1:100

Datum: 30-01-2024

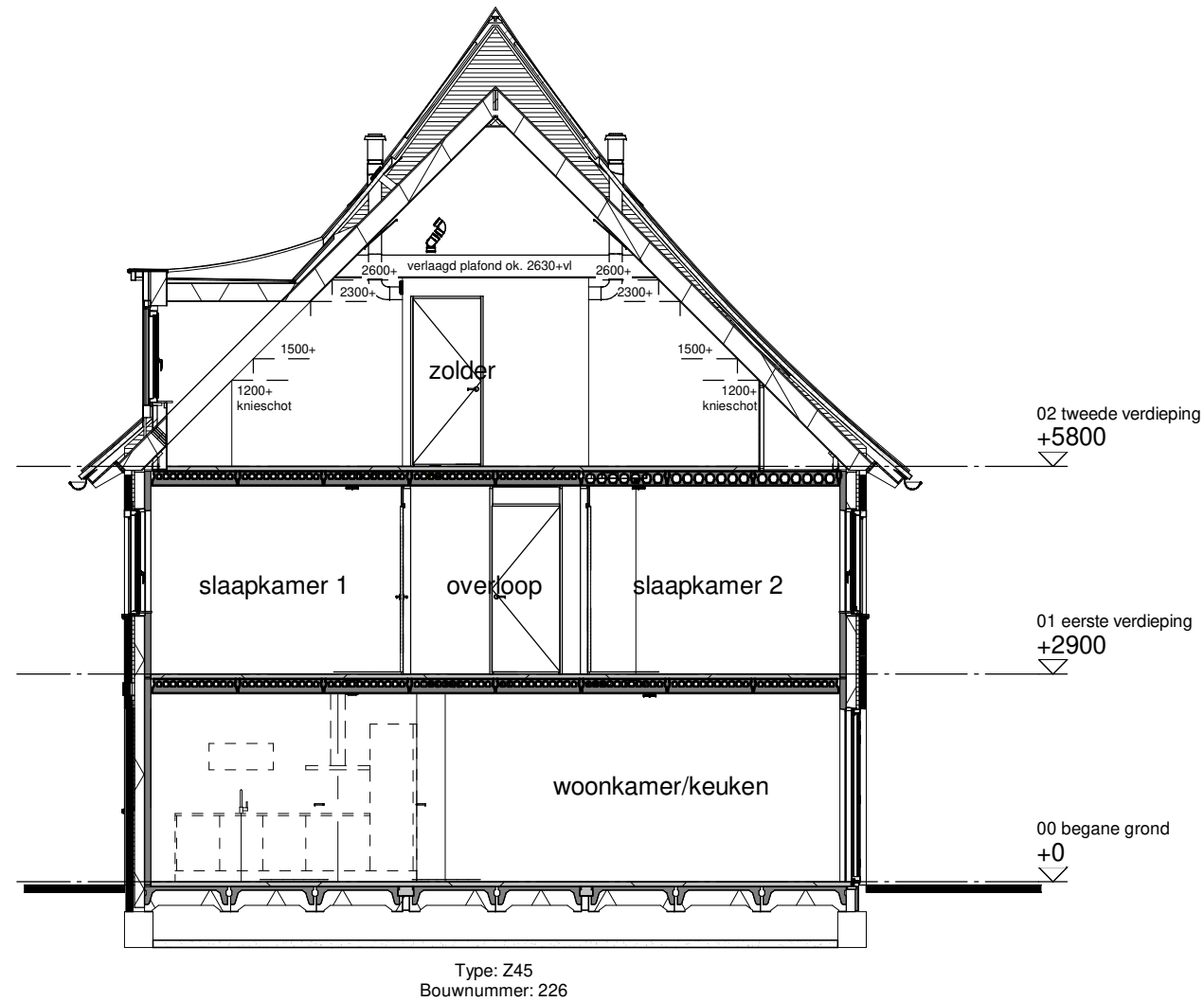

Doorsnede A

ALLEMAAL  
YIELEYAAL

Tekening: Doorsnede blok J2

Woningtype: Z45

Bouwnummer: 219 t/m 226

Bladnummer: VT-J2-00c

Schaal: 1:100

Datum: 30-01-2024

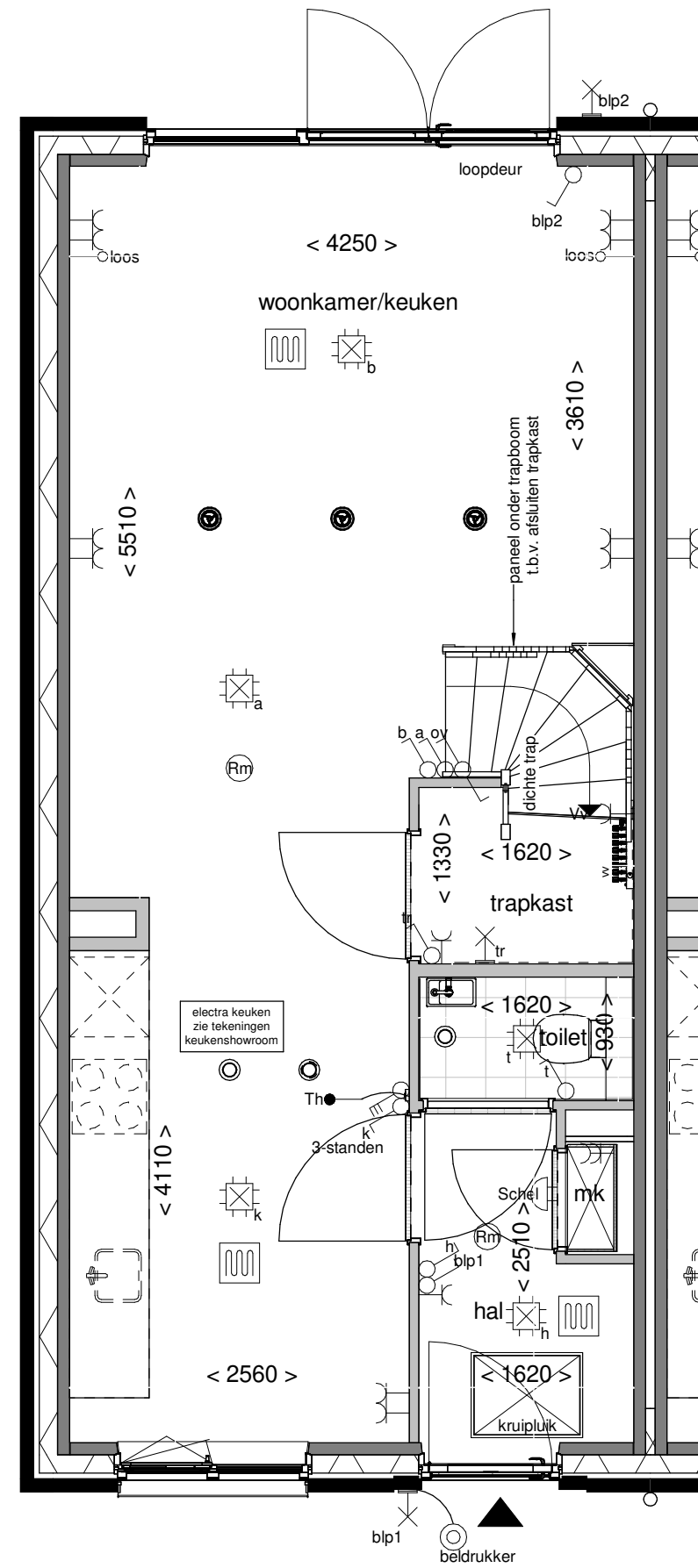

**ALLEMAAL  
YIELEYAAL**

Tekening: Begane grond

Woningtype: Z45

Bouwnummer: 226

Bladnummer: VT-J2-226a

Schaal: 1:50

Datum: 30-01-2024

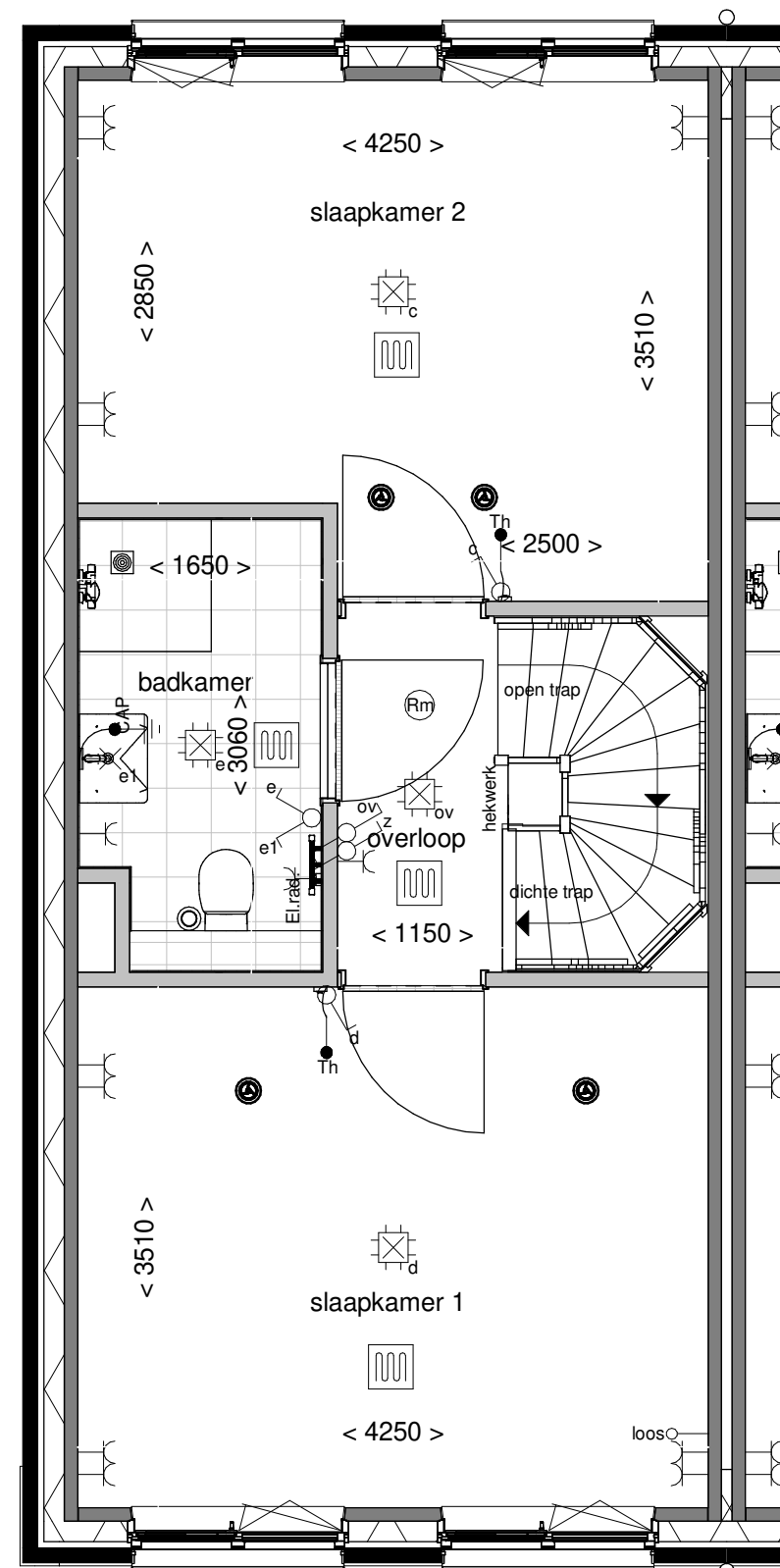

**ALLEMAAL  
VIELEJAAL**

Tekening: Eerste verdieping

---

Woningtype: Z45

---

Bouwnummer: 226

---

Bladnummer: VT-J2-226b

---

Schaal: 1:50

---

Datum: 30-01-2024



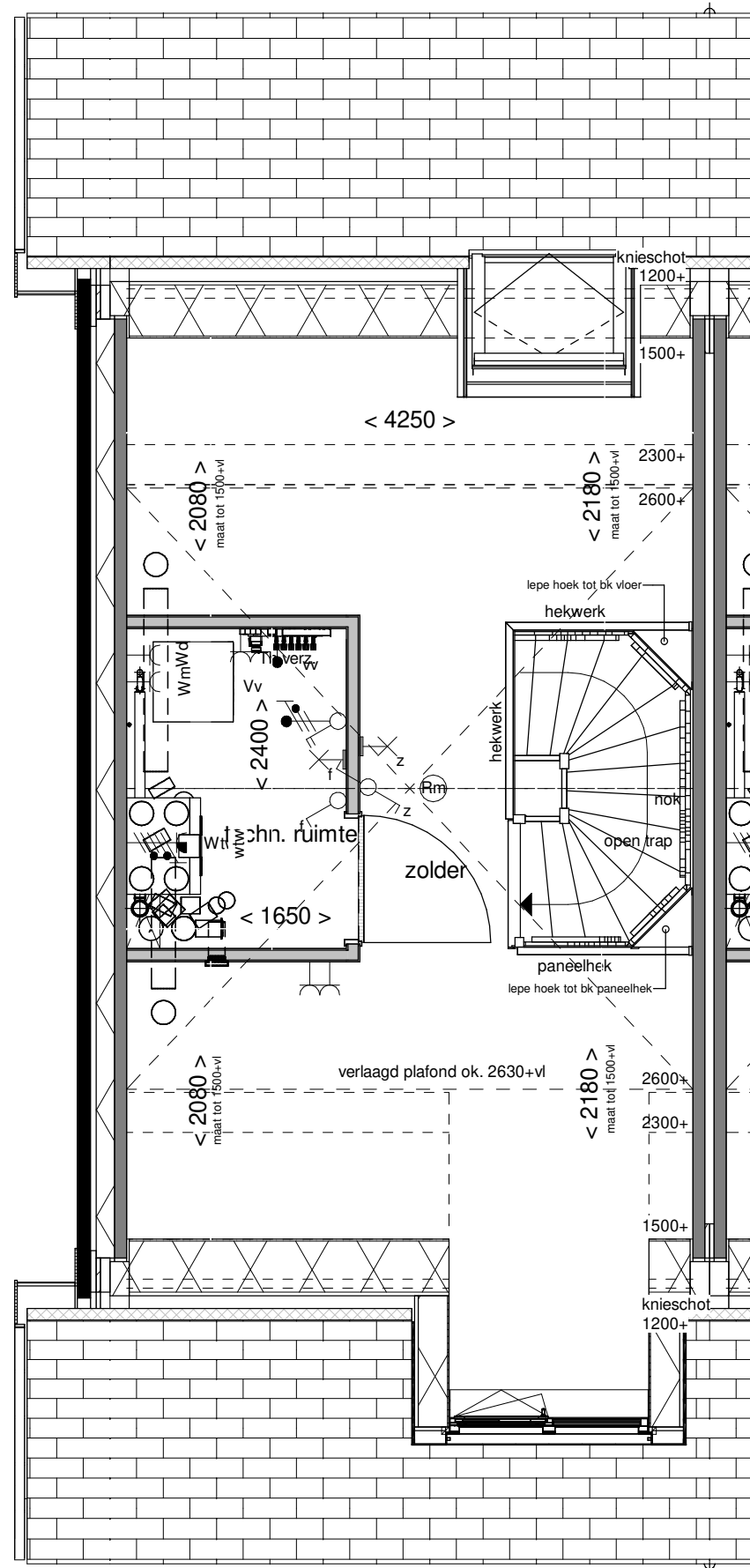

**ALLEMAAL  
YIELEYAAL**

Tekening: Tweede verdieping

Woningtype: Z45

Bouwnummer: 226

Bladnummer: VT-J2-226c

Schaal: 1:50

Datum: 30-01-2024

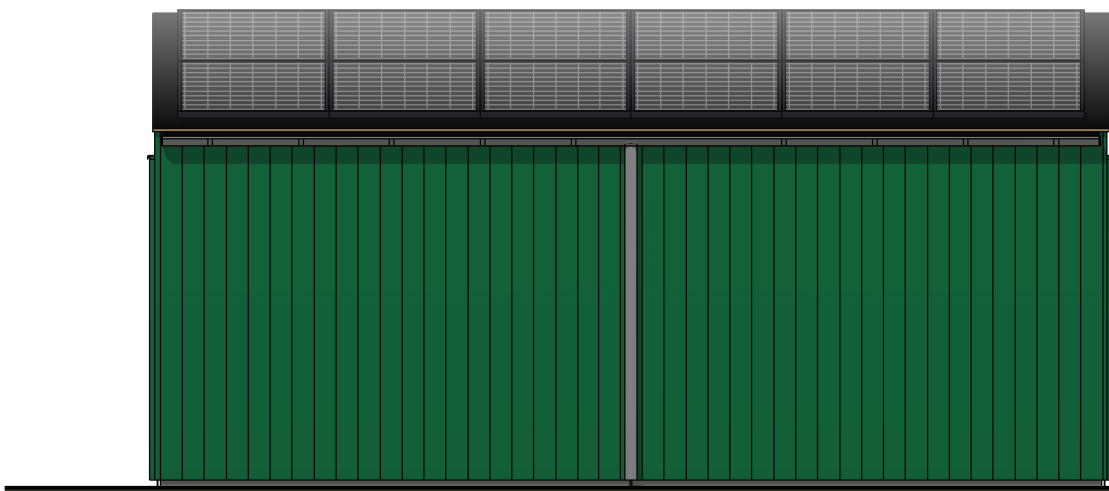

Voorgevel

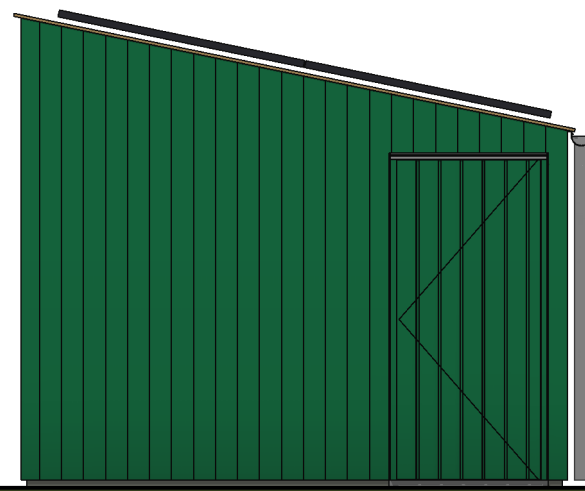

Linker zijgevel

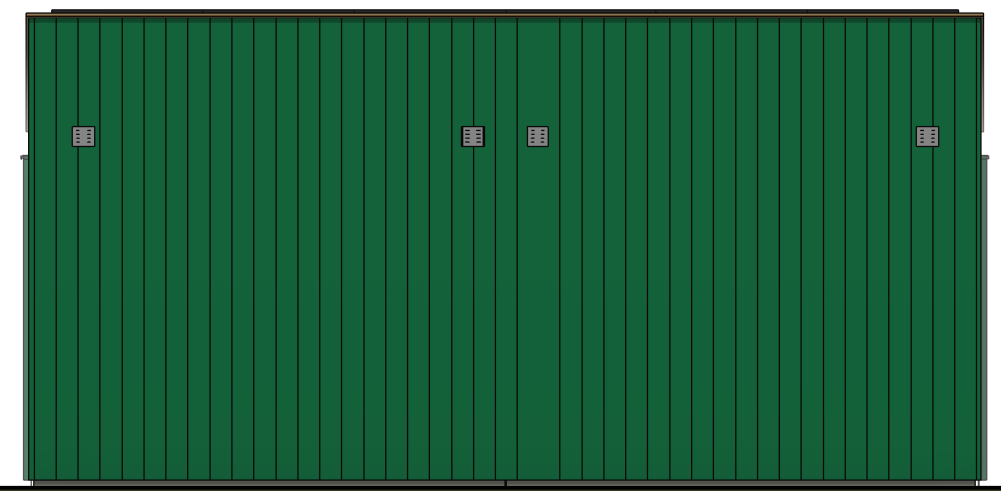

Achtergevel

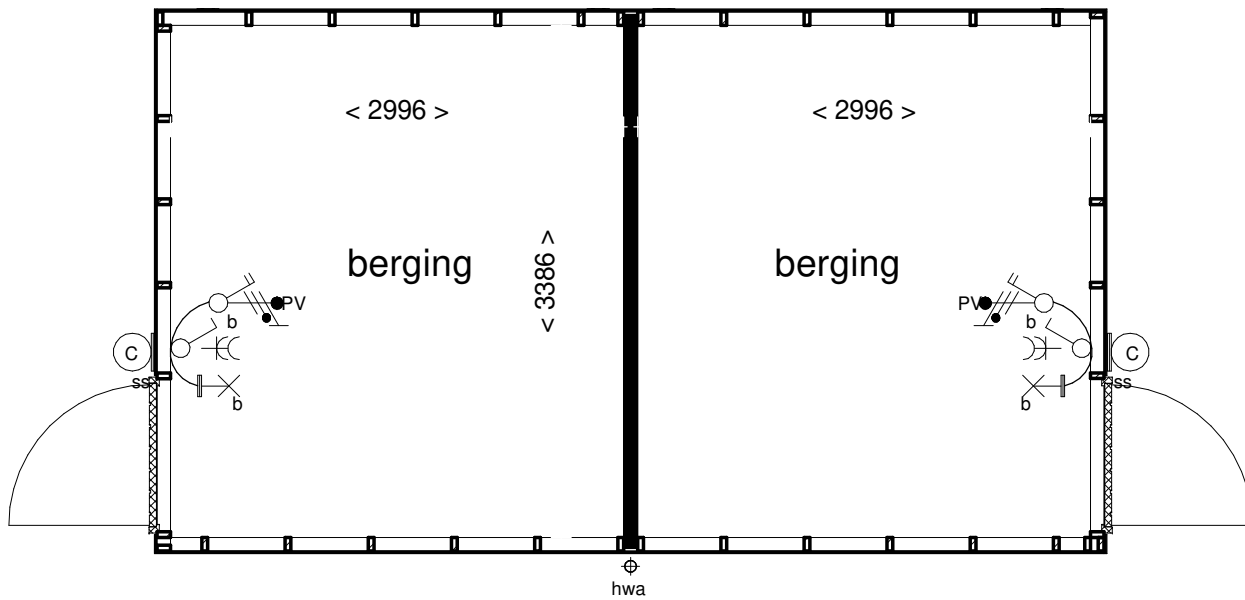

Begane grond

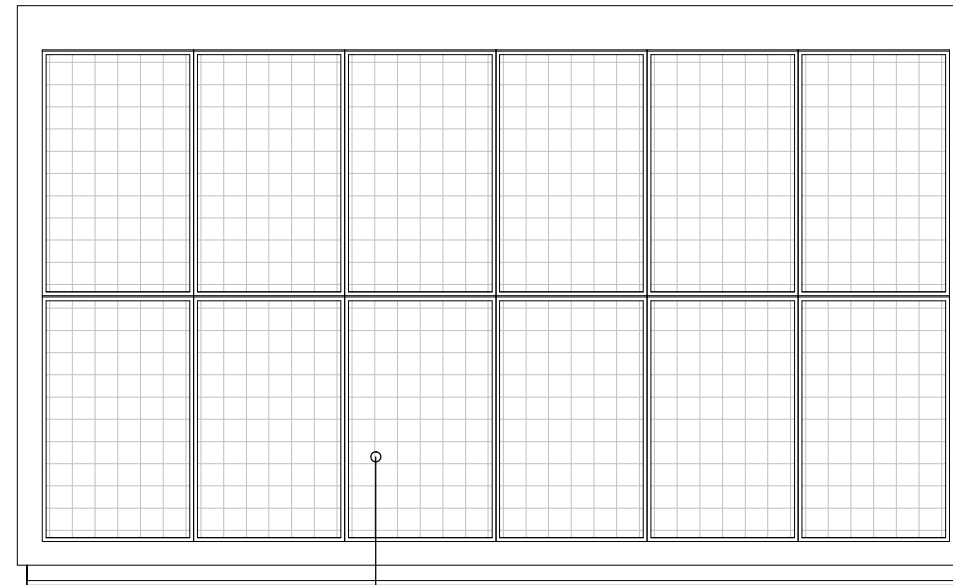

Dakaanzicht

maximaal aantal pv-panelen weergegeven  
aantal kan verschillen per woning/berging

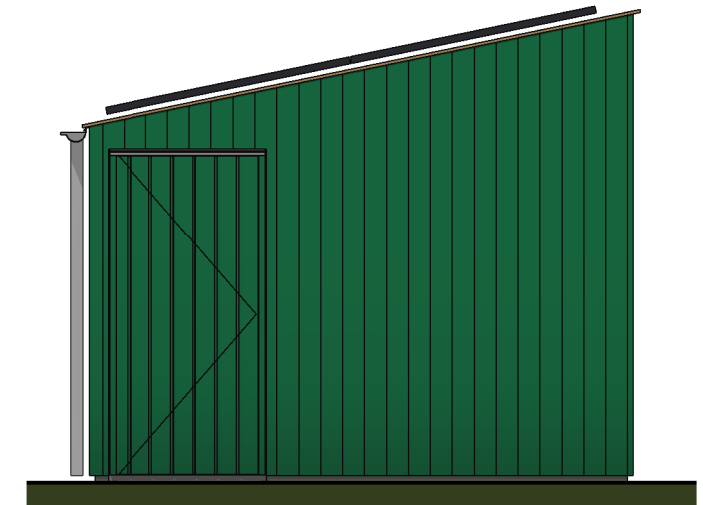

Rechter zijgevel

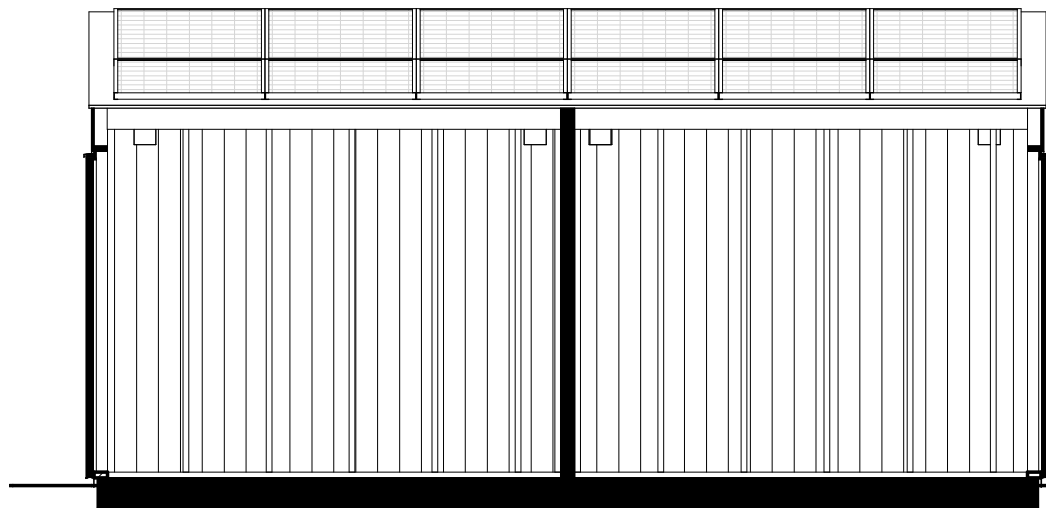

Doorsnede A-A

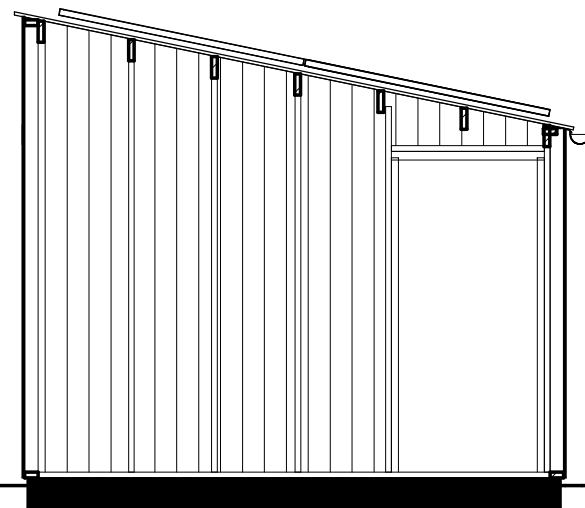

Doorsnede B-B



3D aanzicht

**ALLEMAAL  
YIELEYAAL**

Tekening: **Berging B2**

Woningtype: -

Bouwnummer: 209-210,211-212,213-214,215-216,217-218  
219-220,221-22,223-224,225-226,227-228  
229-230

Bladnummer: **VT-BE03**

Schaal: **1:50**

Datum: **30-01-2024**

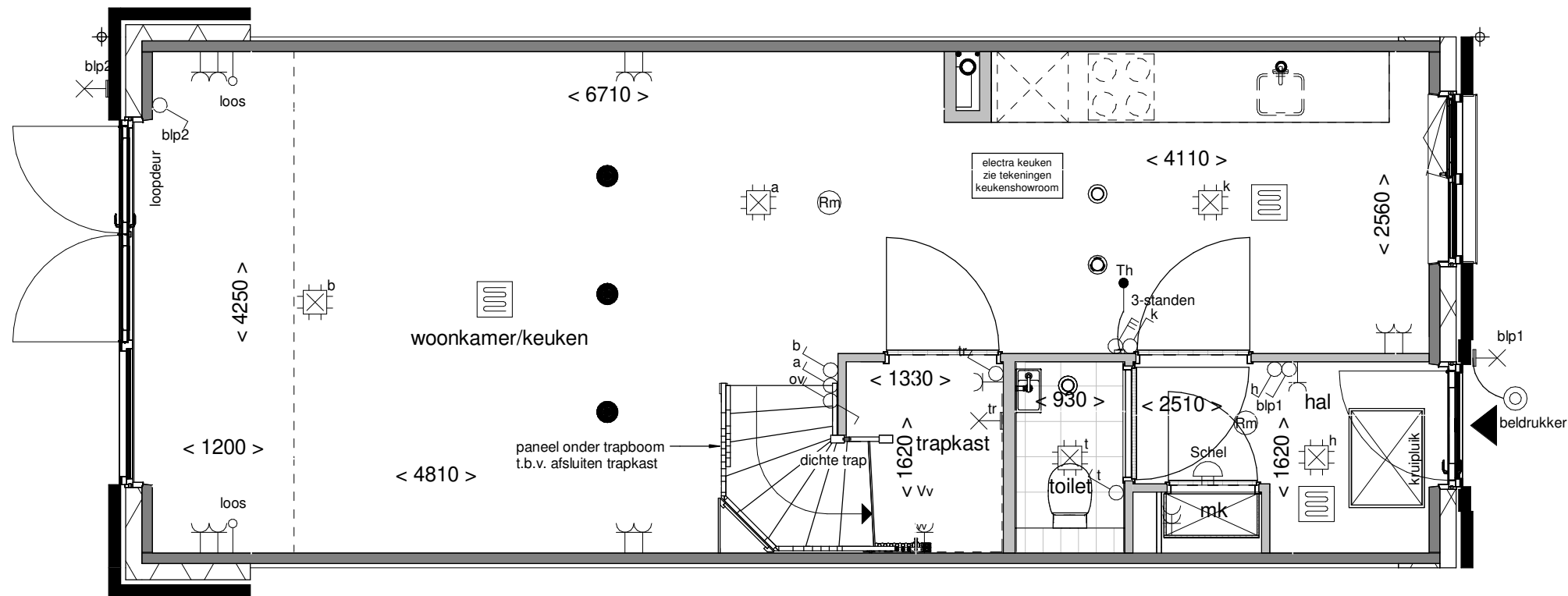

Achtergevel schaal 1:100

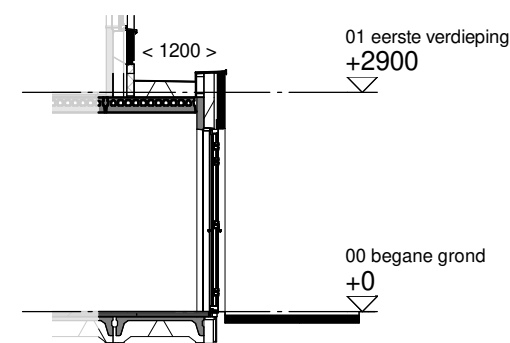

Doorsnede schaal 1:100

**ALLEMAAL  
YIELEYAAL**

Optie: **Uitbouw achtergevel  
1200mm**

Woningtype: **Z45**

Bouwnummer: **-**

Optienummer: **0.A.Z.14**

Schaal: **1:50 / 1:100**

Datum: **30-01-2024**

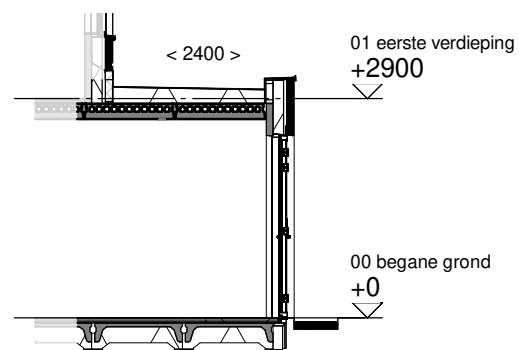
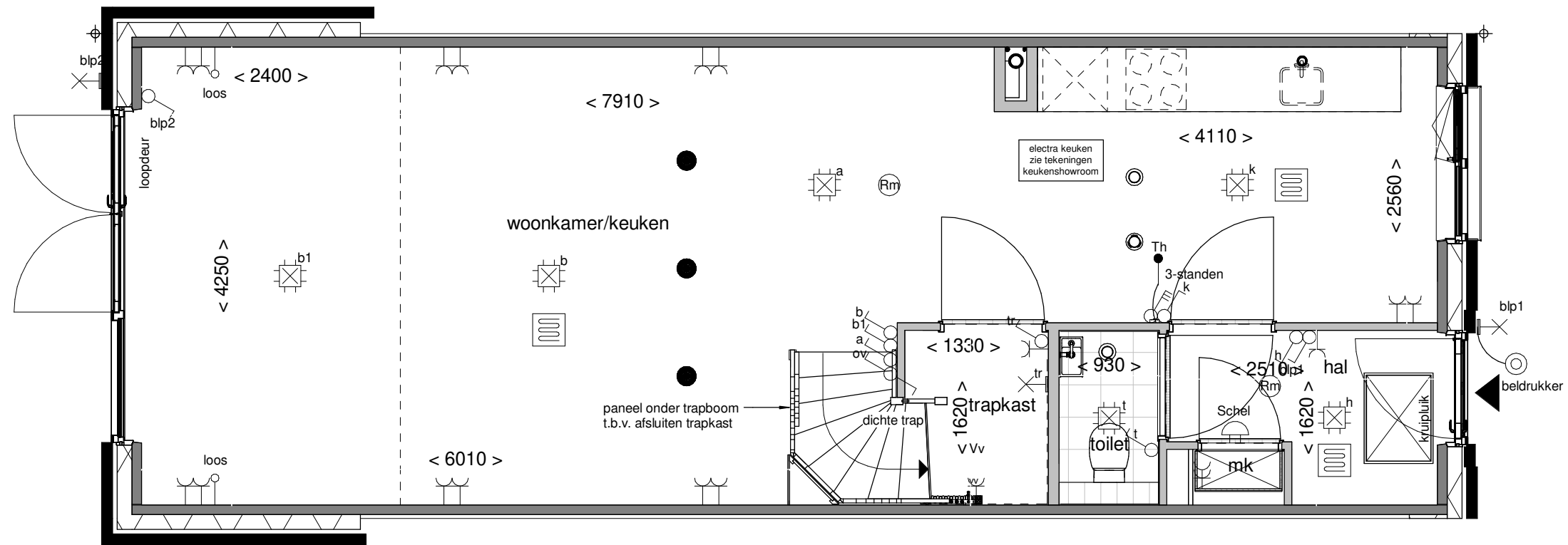

Doorsnede schaal 1:100



Achtergevel schaal 1:100

**ALLEMAAL  
VIELEYAAL**

Optie: Uitbouw achtergevel  
2400mm

Woningtype: Z45

Bouwnummer: -

Optienummer: 0.A.Z.34

Schaal: 1:50 / 1:100

Datum: 30-01-2024

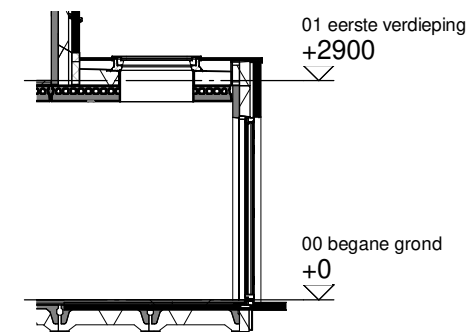
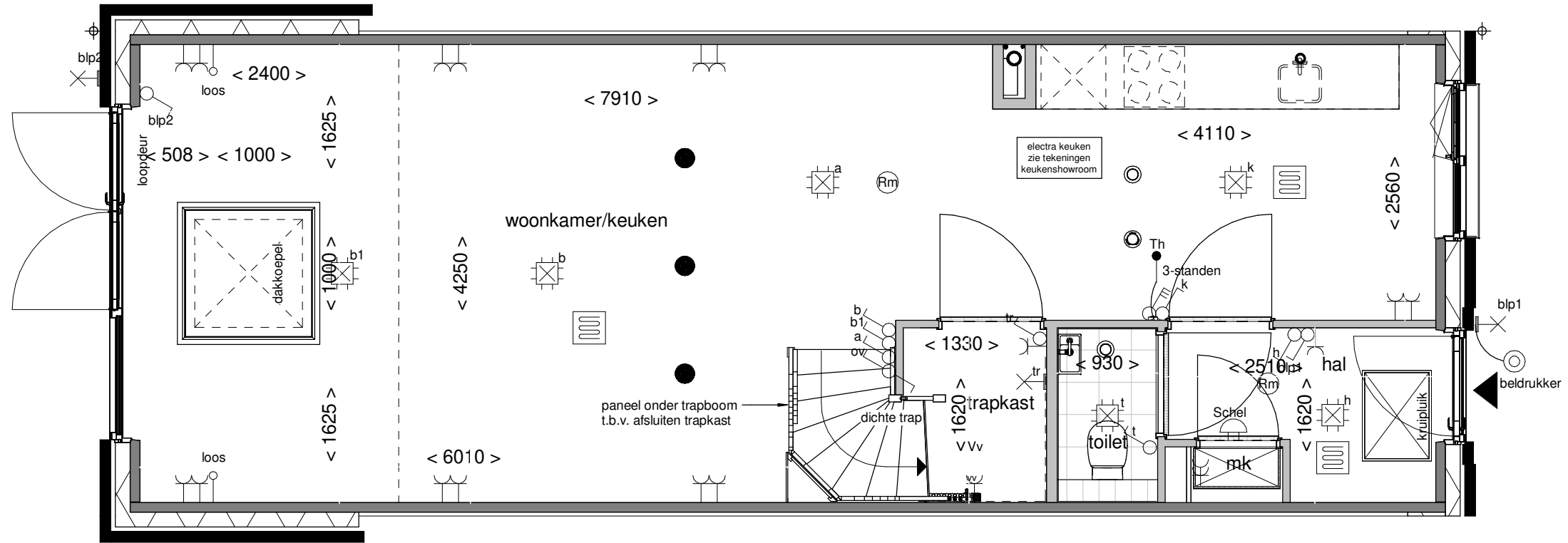

Doorsnede schaal 1:100

**ALLEMAAL  
VIELEYAAL**

Optie: Lichtkoepel in  
uitbouw 2400mm

Woningtype: Z45

Bouwnummer: -

Optienummer: 1.B.X.10

Schaal: 1:50 / 1:100

Datum: 30-01-2024

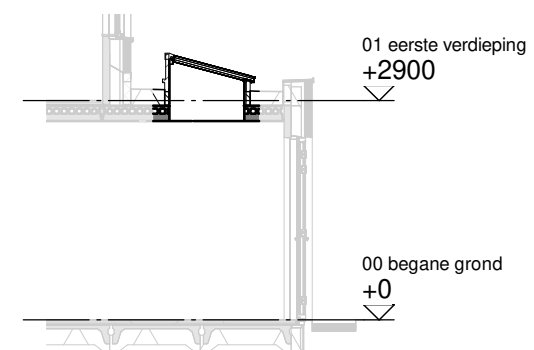
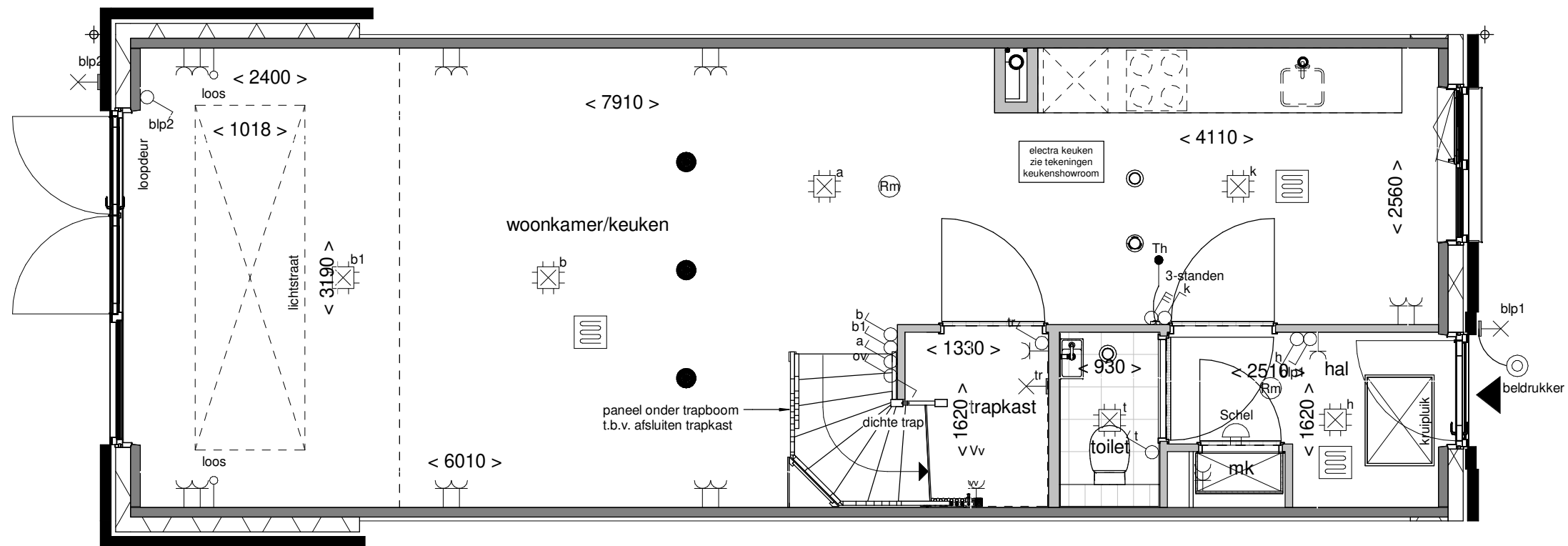

Doorsnede schaal 1:100

**ALLEMAAL  
VIELEYAAL**

Optie: Lichtstraat in uitbouw  
2400mm

Woningtype: Z45

Bouwnummer: -

Optienummer: 1.B.X.14

Schaal: 1:50 / 1:100

Datum: 30-01-2024

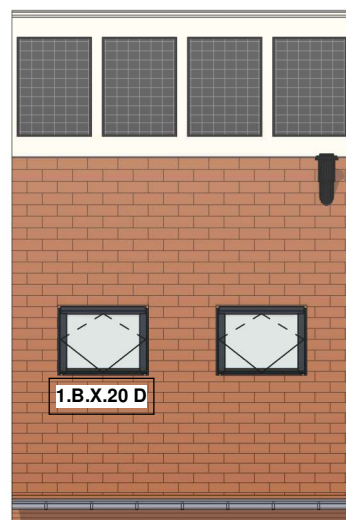
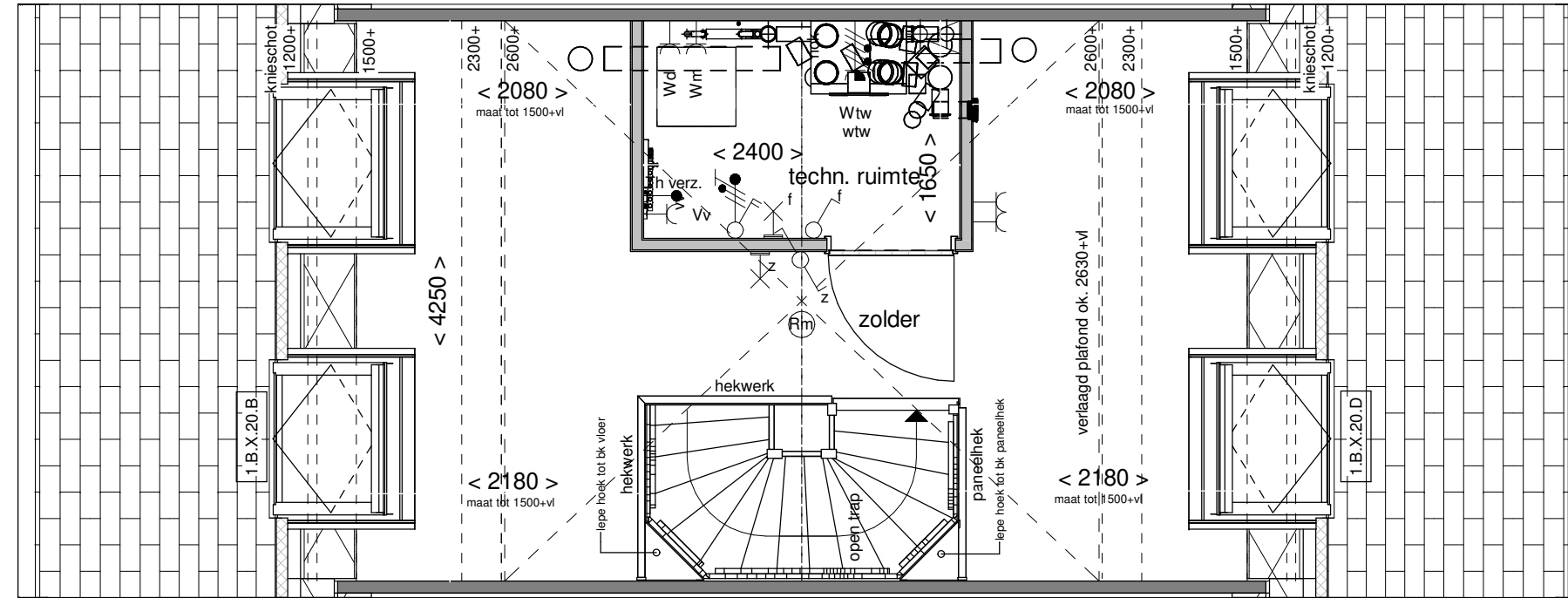

Voorgevel schaal 1:100

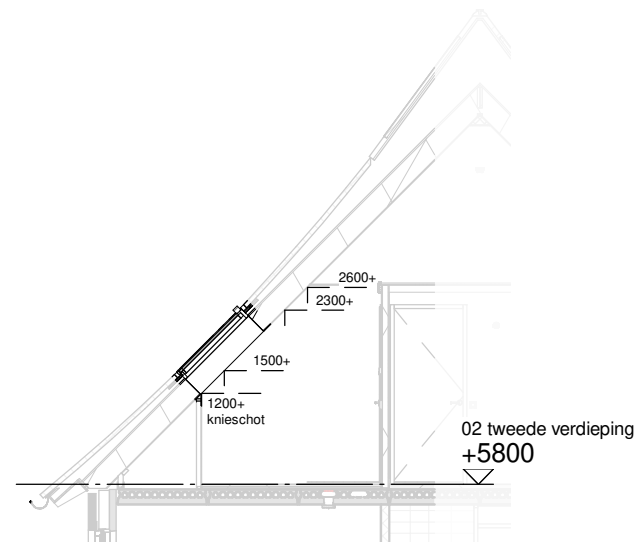

Doorsnede schaal 1:100

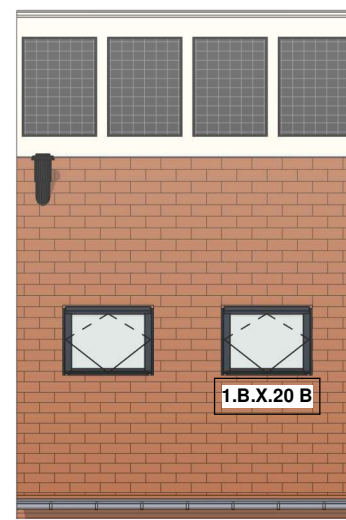

Achtergevel schaal 1:100

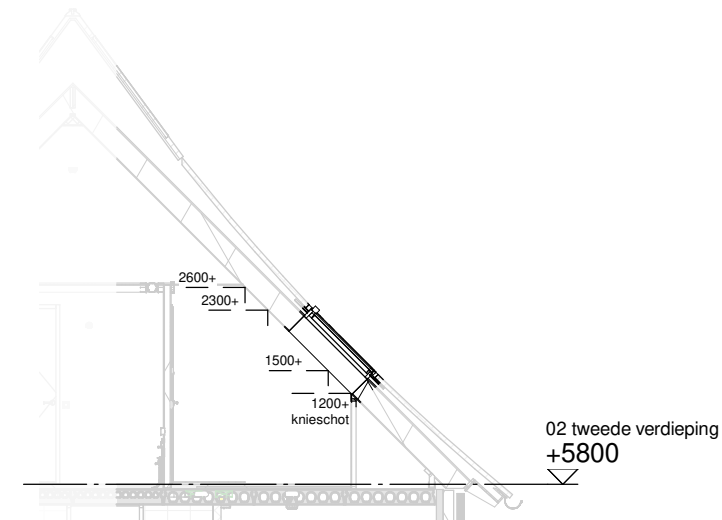

Doorsnede schaal 1:100

**ALLEMAAL  
VIELEYAAL**

Optie: Dakramen voor- en achtergevel

Woningtype: Z45

Bouwnummer: -

Optienummer: 1.B.X.20

Schaal: 1:50 / 1:100

Datum: 30-01-2024

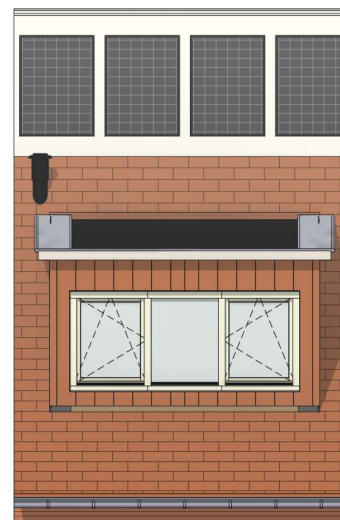
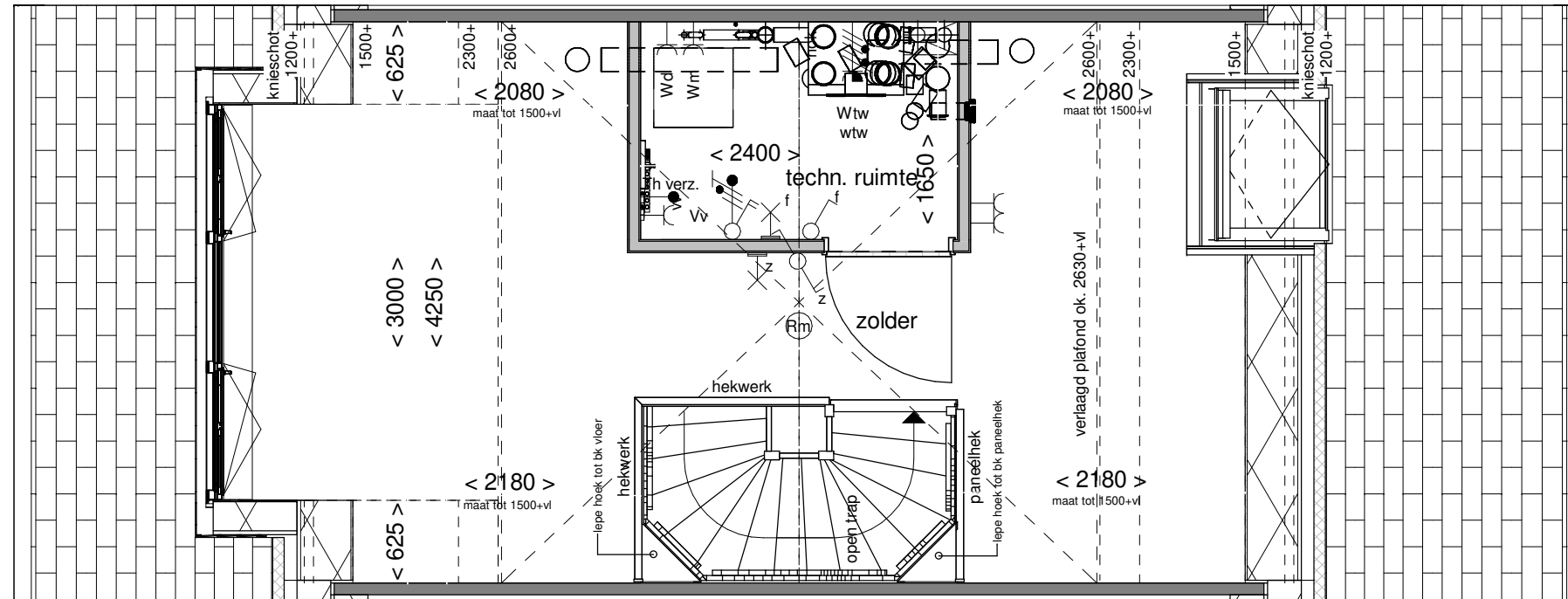

Achtergevel schaal 1:100

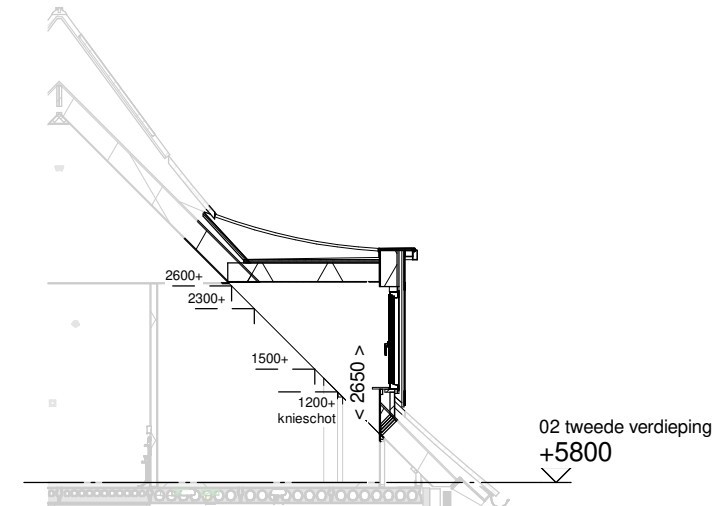

Achtergevel schaal 1:100

**ALLEMAAL  
YIELEYAAL**

Optie: Dakkapel  
achtergevel 3000mm

Woningtype: Z45

Bouwnummer: -

Optienummer: 1.B.X.34

Schaal: 1:50 / 1:100

Datum: 30-01-2024



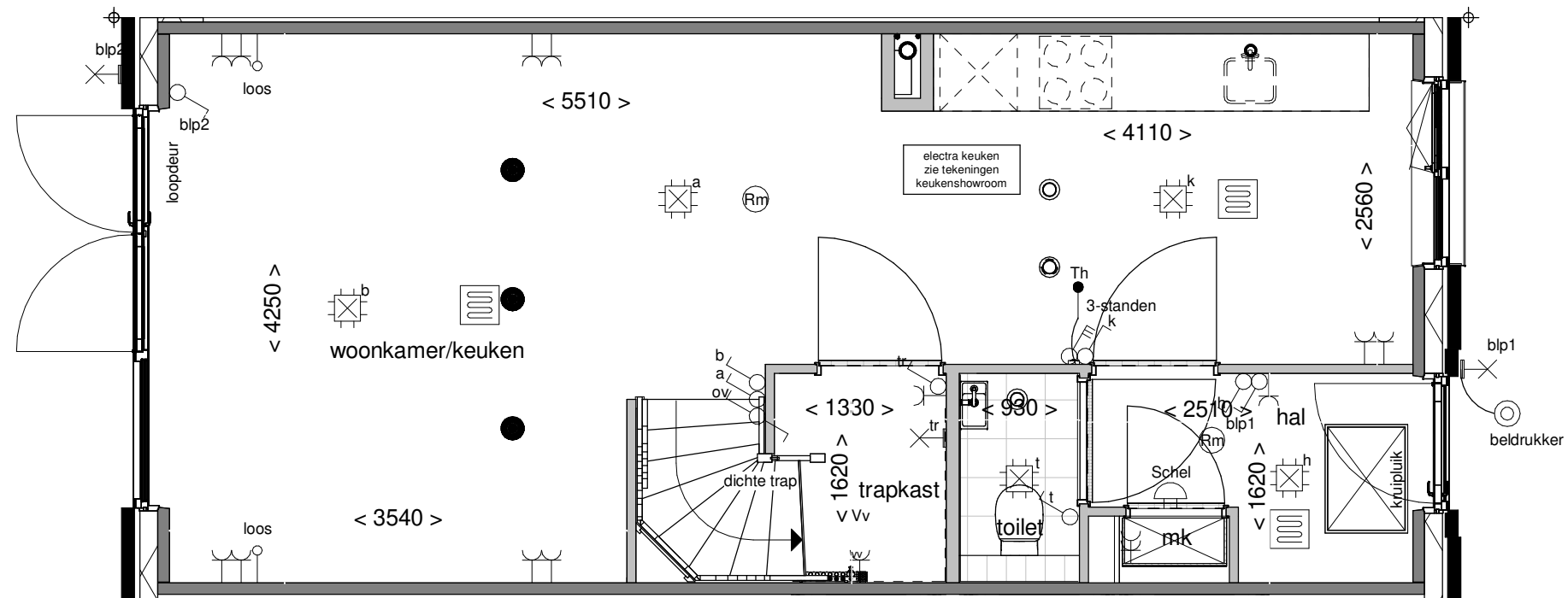

ALLEMAAL  
YIELEYAAL

Optie: Wand naast trap

Woningtype: Z45

Bouwnummer: -

Optienummer: 1.C.Z.10

Schaal: 1:50

Datum: 30-01-2024

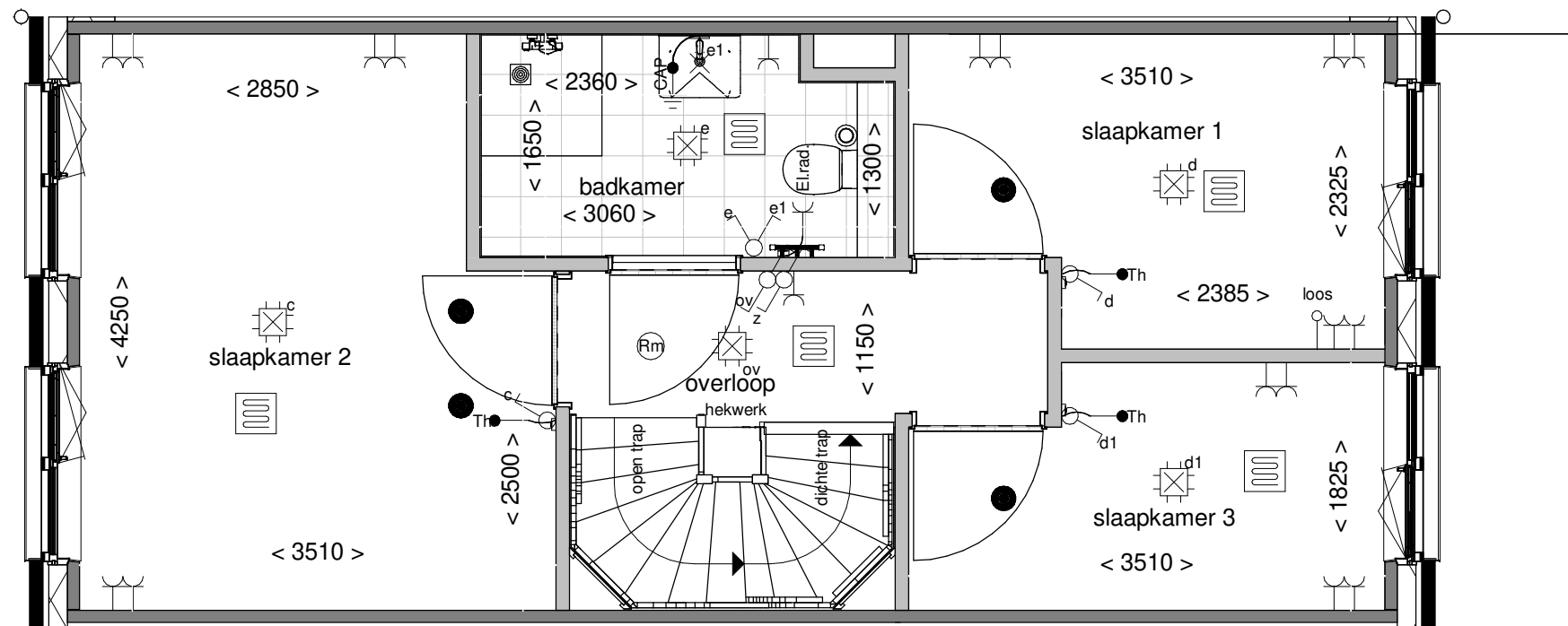

**ALLEMAAL  
VIELEYAAL**

Optie: Twee slaapkamers  
voorzijde

Woningtype: Z45

Bouwnummer: -

Optienummer: 1.C.Z.36

Schaal: 1:50

Datum: 30-01-2024

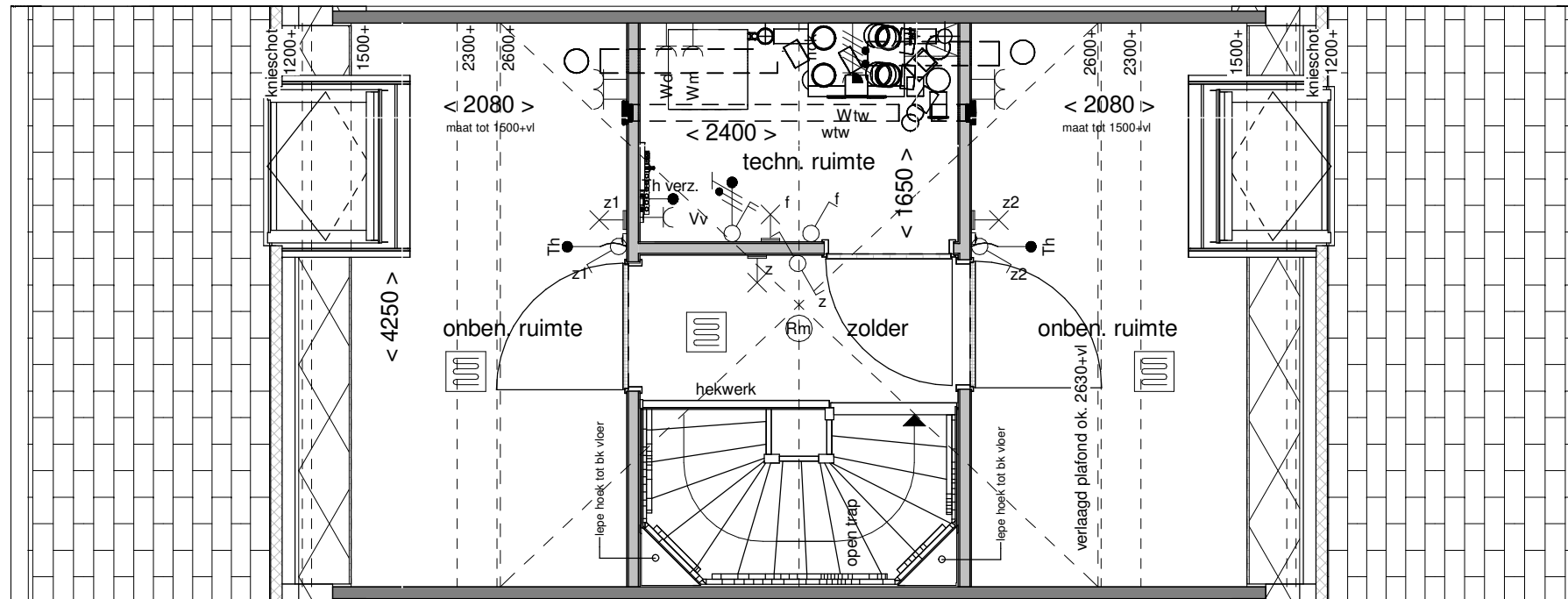

**ALLEMAAL  
VIELEYAAL**

Optie: Indeling techn.- en  
2 onb. ruimtes

Woningtype: Z45

Bouwnummer: -

Optienummer: 1.C.Z.76

Schaal: 1:50

Datum: 30-01-2024