

**ALLEMAAL
YIELEYAAL**

Tekening: Situatie Fase 5-6
 Woningtype: _____
 Bouwnummer: _____
 Bladnummer: VT-S-01
 Schaal: 1:1000
 Datum: 30-01-2024

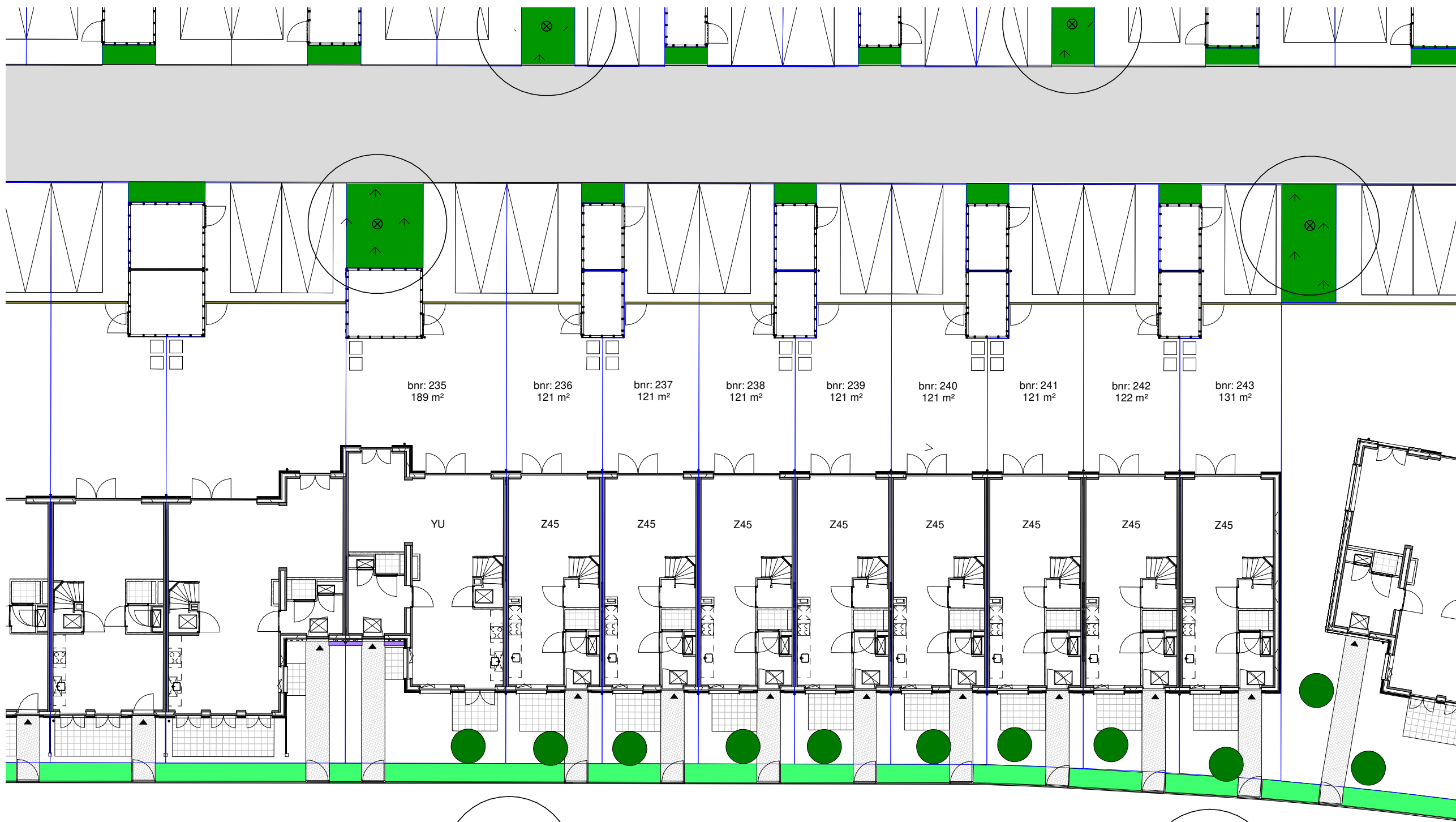

Renvooi

- entree woning
- parkeervak eigen terrein
- erfgrans
- beplanting type n.t.b. koper
- opstelplaats kliko
- tuinhekje
- klinkerbestrating
- betontegels 300x300mm
- groen strook
- haag h=900mm
- haag h=1800mm
- bamboehok h=1800mm
- gaashek met klimplanten en poort h=1600mm
- klimplant

parkeerplekken en posities bomen en struiken zijn indicatief













Rollostraat

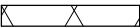

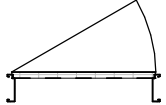
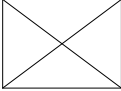

























**ALLEMAAL
YIELEYAAL**

Tekening: Situatie Blok K2
 Woningtype: YU, Z45
 Bouwnummer: 235-243
 Bladnummer: VT-S-10
 Schaal: 1:200
 Datum: 30-01-2024

Renvooi bouwkundig

	metselwerk kleur A
	dakpannen kleur oranje
	entree woning
	metselwerk
	isolatie
	dragende wand
	niet dragende binnenwand
	binnendeurkozijn (met bovenlicht)
	kruipluik
	opstelplaats wasmachine
	opstelplaats wasdroger
	
	principe opstelling keukenblok

Renvooi installaties

	aansluitpunt licht
	aansluitpunt licht, wand
	centraaldoos met lichtpunt
	armatuur aan de wand
	rookmelder
	aansluitpunt niet bedraad
	verdeelinrichting / meterkast / groepenkast
	beldrukker
	schel
	schakelaar, 1-polig
	werkschakelaar tbv PV-panelen
	schakelaar, 3-polig
	schakelaar, wissel
	schakelaar, kruis
	schakelaar, serie
	wandcontactdoos 1-voudig met beschermingscontact
	wandcontactdoos 2-voudig met beschermingscontact, verticaal
	wandcontactdoos 2-voudig met beschermingscontact
	thermostaatleiding, bedraad
	mechanische ventilatie-unit incl. warmteterugwinunit
	warmtepomp
	inblaasventiel mechanische ventilatie
	afzuigventiel mechanische ventilatie
	
	verdeler vloerverwarming
	Afleverzet stadswarmte
	ruimte voorzien van vloerverwarming
	elektrische radiator
	kanalen in het zicht

Disclaimer

De op deze tekeningen aangegeven maten zijn circa maten in millimeters en tussen de wanden / vloeren gemeten, waarbij geen rekening is gehouden met enige wandafwerking, plinten, aftimmering, ect. In verband met de nauwkeurige uitwerking van details, constructie, maatvoering, materialen e.d. kunnen er kleine afwijkingen ontstaan ten opzichte van de nu vermelde gegevens. Deze geringe afwijkingen geven geen aanleiding tot verrekening. Aan de op deze tekening aangegeven maten kunnen derhalve geen rechten worden ontleend. De op deze tekeningen aangegeven maatvoering is niet geschikt voor opdrachten aan derden door koper(s). De posities van aansluitingen en installatie onderdelen zijn indicatief op tekening aangegeven. De exacte aantallen en posities zullen na berekening in het werk door de installateurs worden bepaald en kunnen afwijken van deze tekening.

**ALLEMAAL
YIELEYAAL**

Tekening: Renvooi

Woningtype: -

Bouwnummer: -

Bladnummer: VT-0-00c

Schaal: -

Datum: 30-01-2024



Type: YU Bouwnummer: 235 Type: Z45 Bouwnummer: 236 Type: Z45 Bouwnummer: 237 Type: Z45 Bouwnummer: 238 Type: Z45 Bouwnummer: 239 Type: Z45 Bouwnummer: 240 Type: Z45 Bouwnummer: 241 Type: Z45 Bouwnummer: 242 Type: Z45 Bouwnummer: 243

Voorgevel



Type: Z45 Bouwnummer: 243 Type: Z45 Bouwnummer: 242 Type: Z45 Bouwnummer: 241 Type: Z45 Bouwnummer: 240 Type: Z45 Bouwnummer: 239 Type: Z45 Bouwnummer: 238 Type: Z45 Bouwnummer: 237 Type: Z45 Bouwnummer: 236 Type: YU Bouwnummer: 235

Achtergevel

**ALLEMAAL
YIELEYAAL**

Tekening: Gevels blok K2

Woningtype: Z45, YU

Bouwnummer: 235 t/m 243

Bladnummer: VT-K2-00a

Schaal: 1:150

Datum: 30-01-2024



Type: YU
bwnr: 235

Linker zijgevel

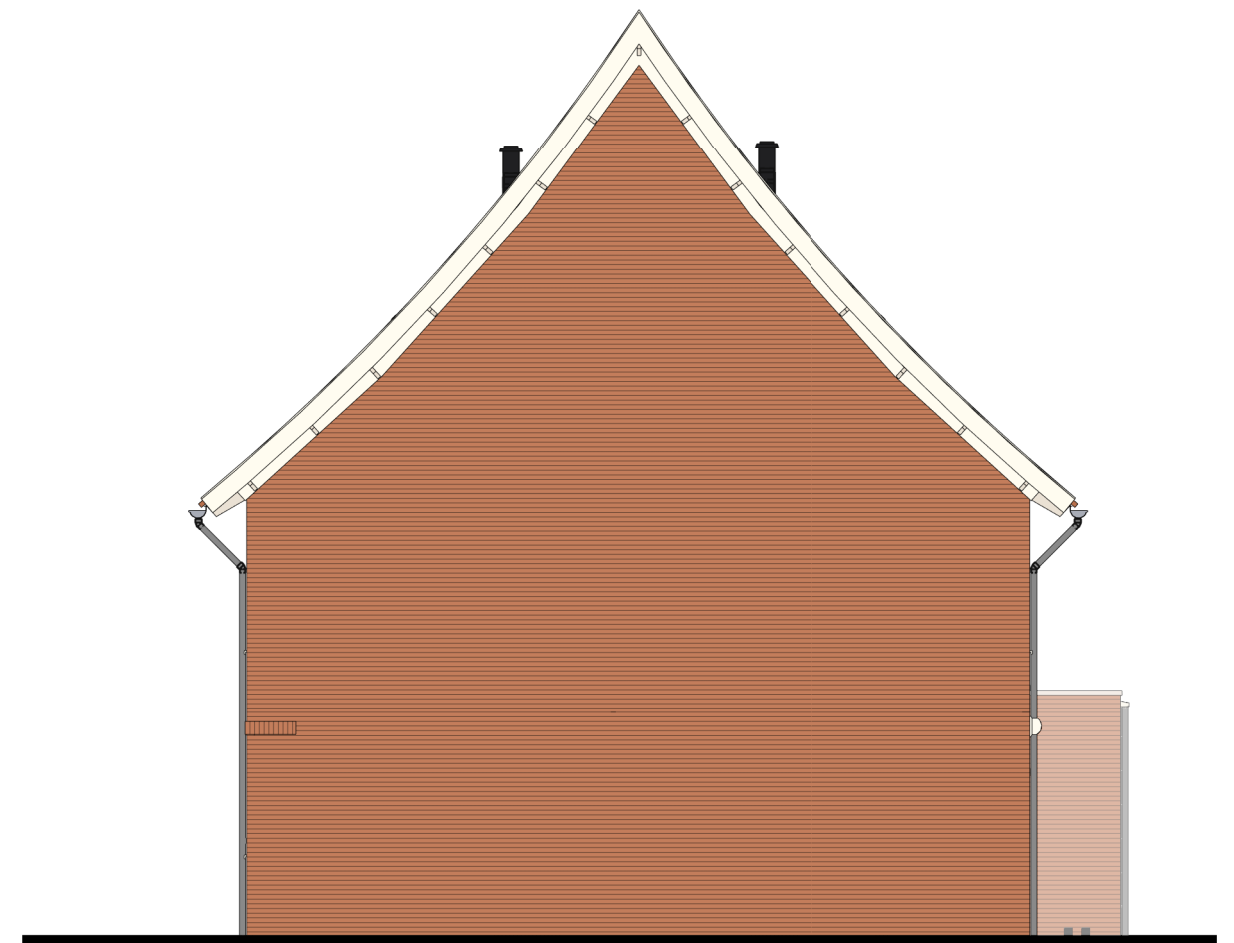

Type: Z45
bwnr: 243

Rechter zijgevel

**ALLEMAAL
YIELEYAAL**

Tekening: Zijgevels blok K2

Woningtype: Z45, YU

Bouwnummer: 235 t/m 243

Bladnummer: VT-K2-00b

Schaal: 1:100

Datum: 30-01-2024

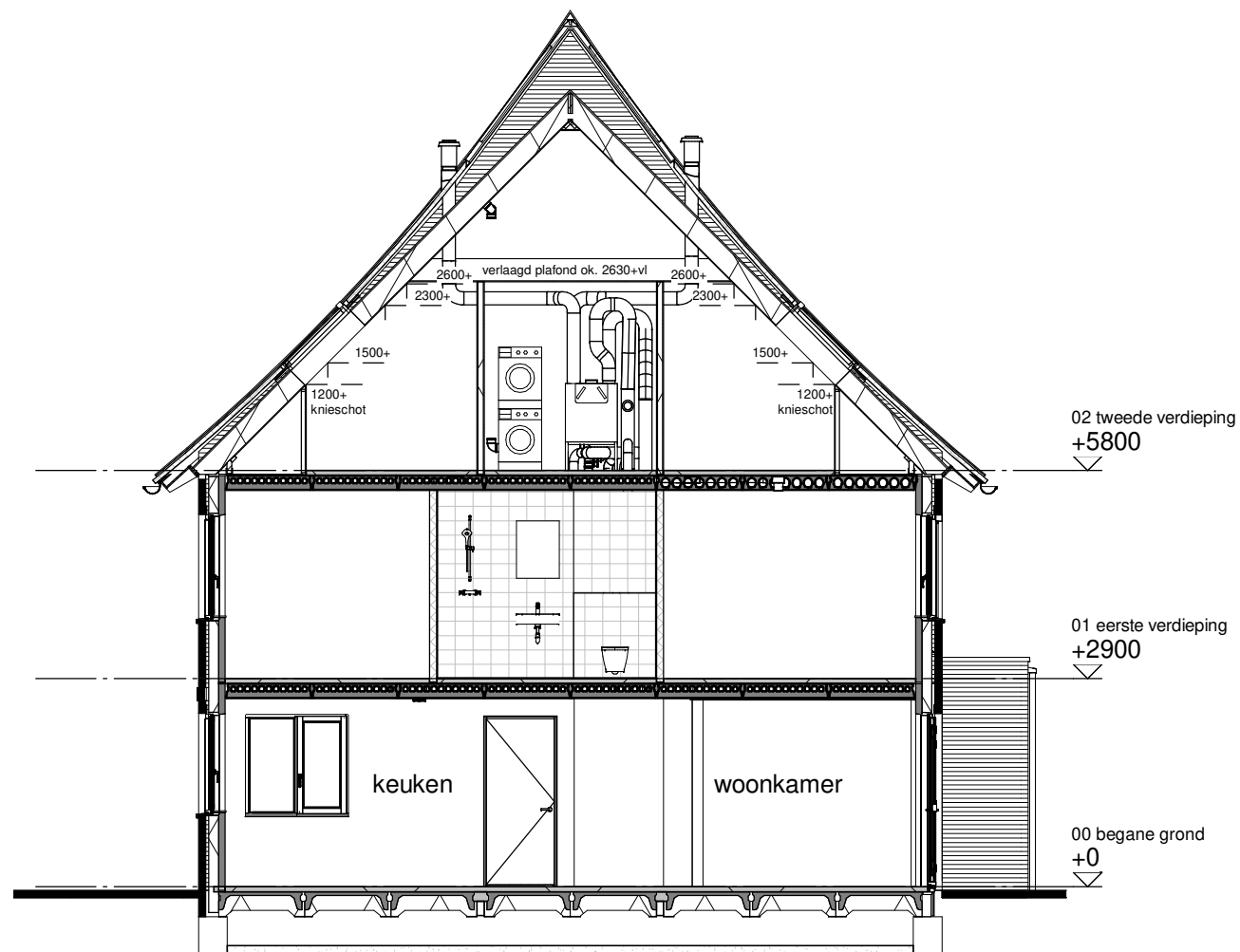

Type: YU
Bouwnummer: 235

Doorsnede A

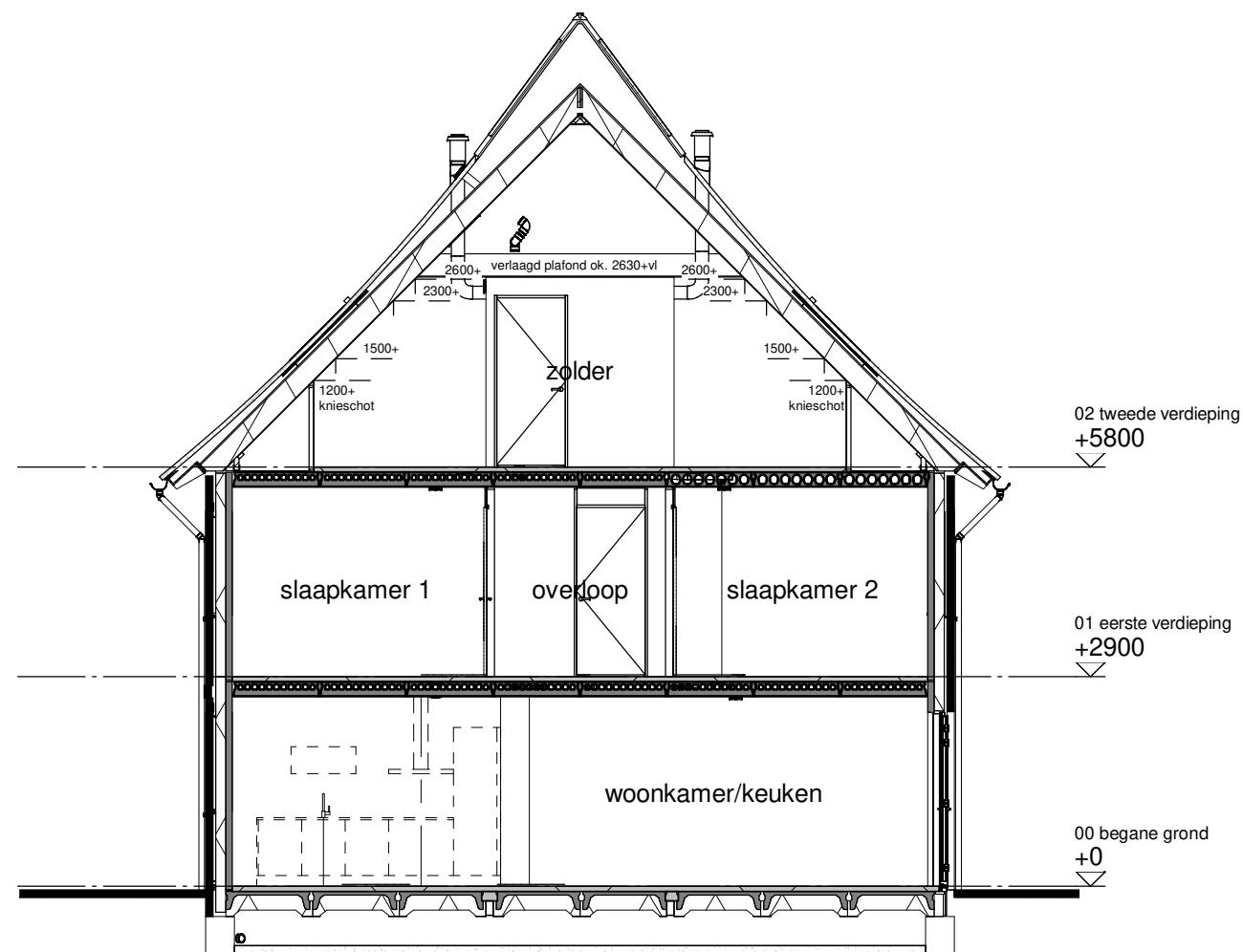

Type: Z45
Bouwnummer: 236

Doorsnede B

**ALLEMAAL
YIELEYAAL**

Tekening: Doorsnedes blok K2

Woningtype: Z45, YU

Bouwnummer: 235 t/m 243

Bladnummer: VT-K2-00c

Schaal: 1:100

Datum: 30-01-2024

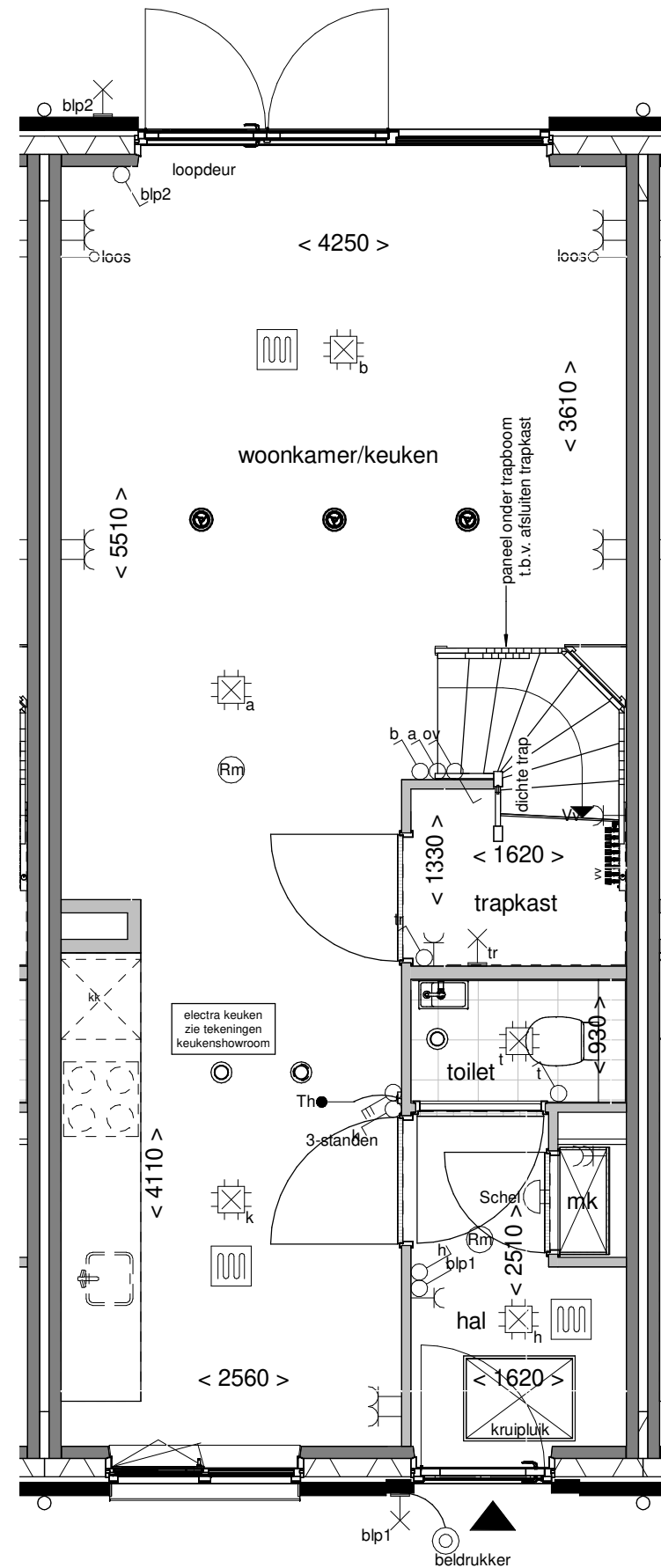

**ALLEMAAL
VIELEJAAL**

Tekening: Begane grond

Woningtype: Z45

Bouwnummer: 237

Bladnummer: VT-K2-237a

Schaal: 1:50

Datum: 30-01-2024

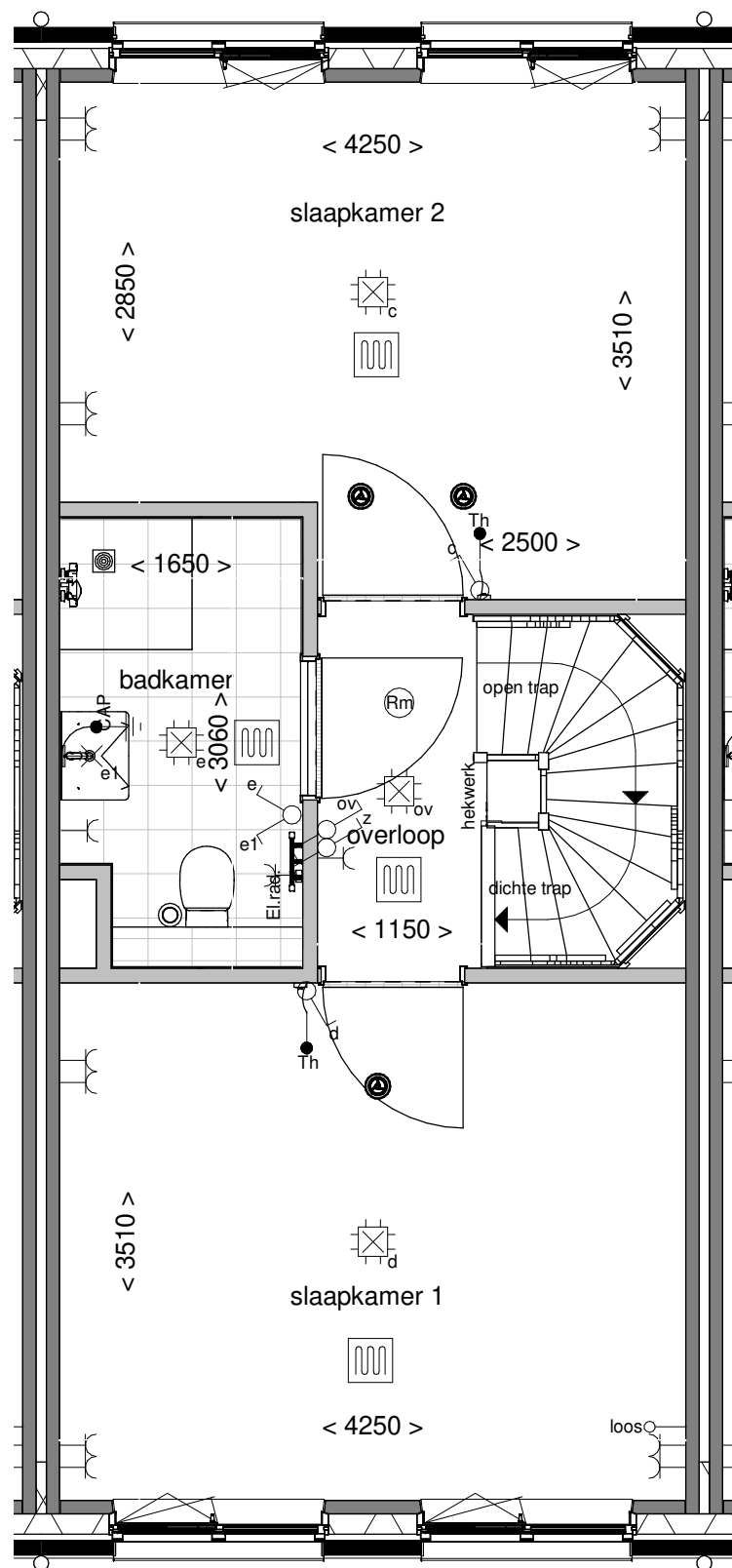

**ALLEMAAL
YIELEYAAL**

Tekening: Eerste verdieping

Woningtype: Z45

Bouwnummer: 237

Bladnummer: VT-K2-237b

Schaal: 1:50

Datum: 30-01-2024

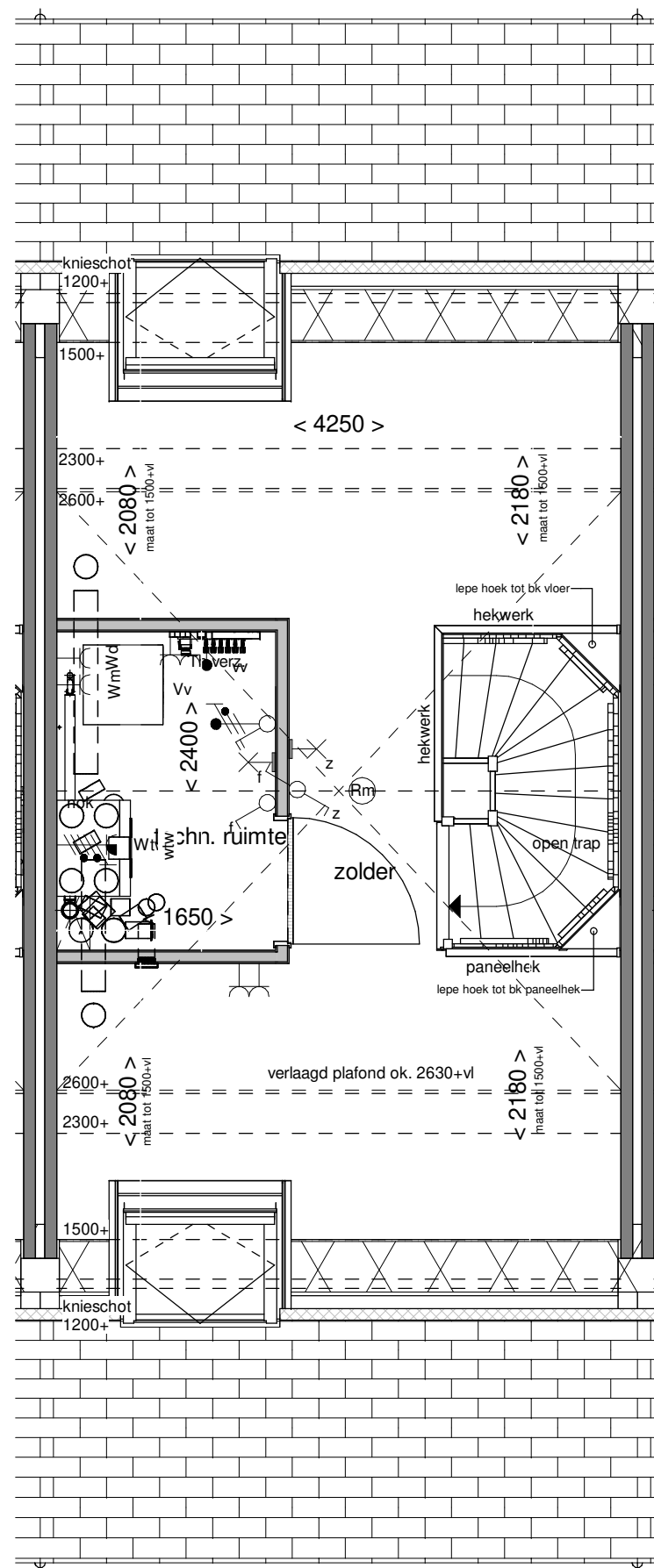

**ALLEMAAL
VIELEJAAL**

Tekening: Tweede verdieping

Woningtype: Z45

Bouwnummer: 237

Bladnummer: VT-K2-237c

Schaal: 1:50

Datum: 30-01-2024



Voorgevel

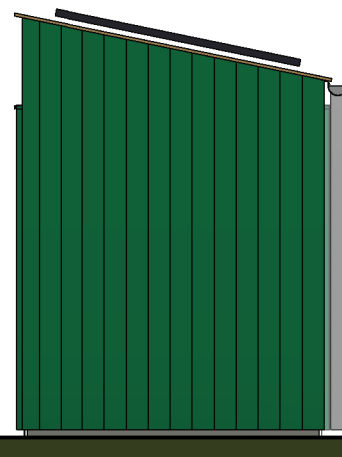

Linker zijgevel

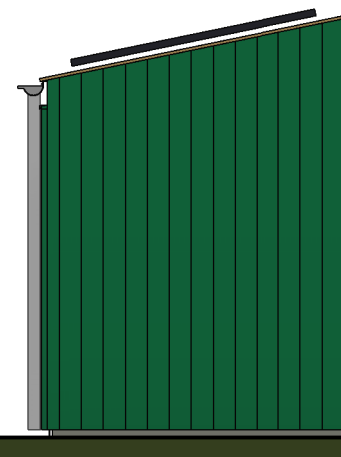

Rechter zijgevel

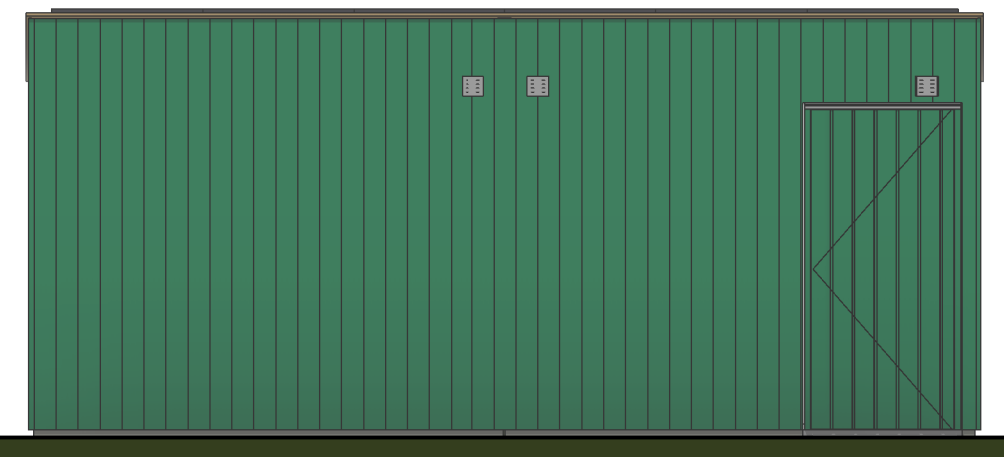

Achtergevel

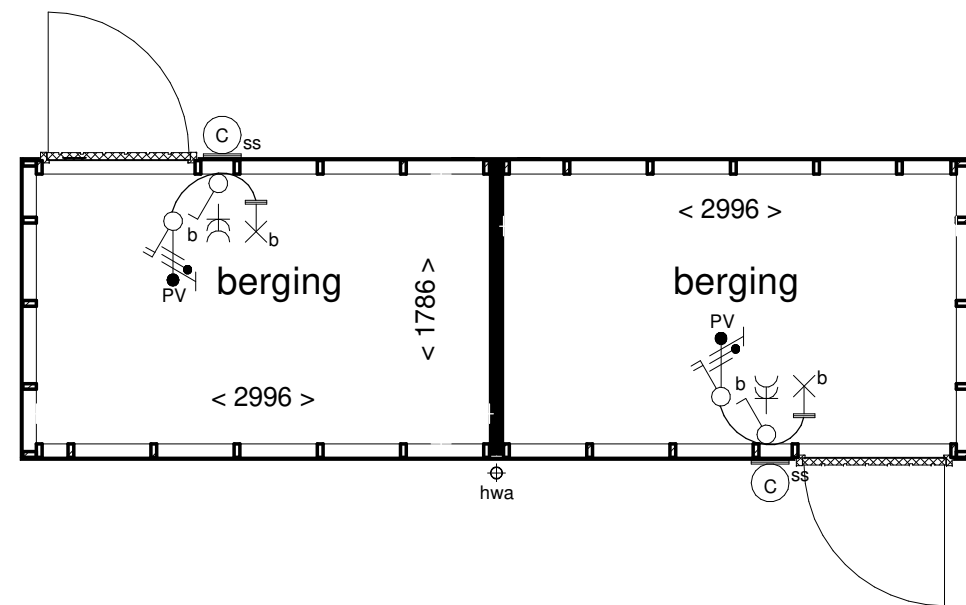

Begane grond

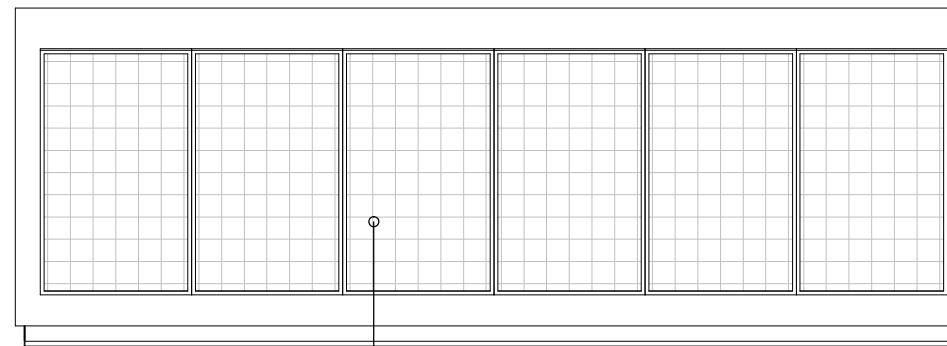

Dakaanzicht

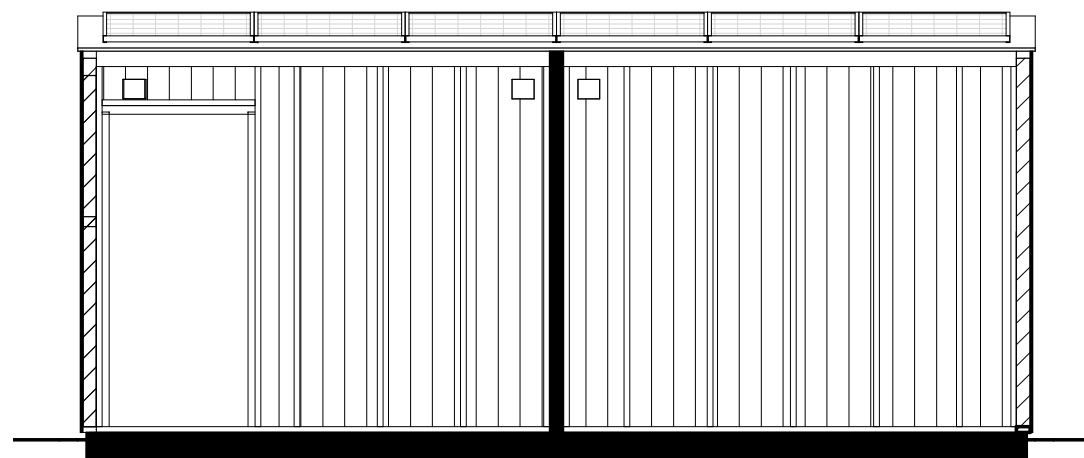

Doorsnede A-A

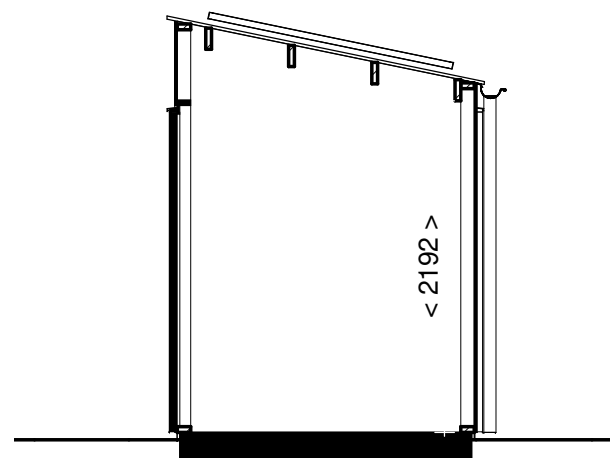

Doorsnede B-B

Als getekend:

bnr. 236 - 237
 bnr. 238 - 239
 bnr. 240 - 241
 bnr. 242 - 243
 bnr. 272 - 273
 bnr. 274 - 275
 bnr. 276 - 277
 bnr. 278 - 279
 bnr. 280 - 281
 bnr. 282 - 283
 bnr. 284 - 285
 bnr. 286 - 287
 bnr. 288 - 289
 bnr. 290 - 291
 bnr. 292 - 293

Gespiegeld:

bnr. 261 - 262
 bnr. 263 - 264
 bnr. 296 - 297
 bnr. 298 - 299

**ALLEMAAL
 YIELEYAAL**

Tekening: **Berging A**

Woningtype: -

Bouwnummer:

Bladnummer: **VT-BE01**

Schaal: **1:50**

Datum: **30-01-2024**

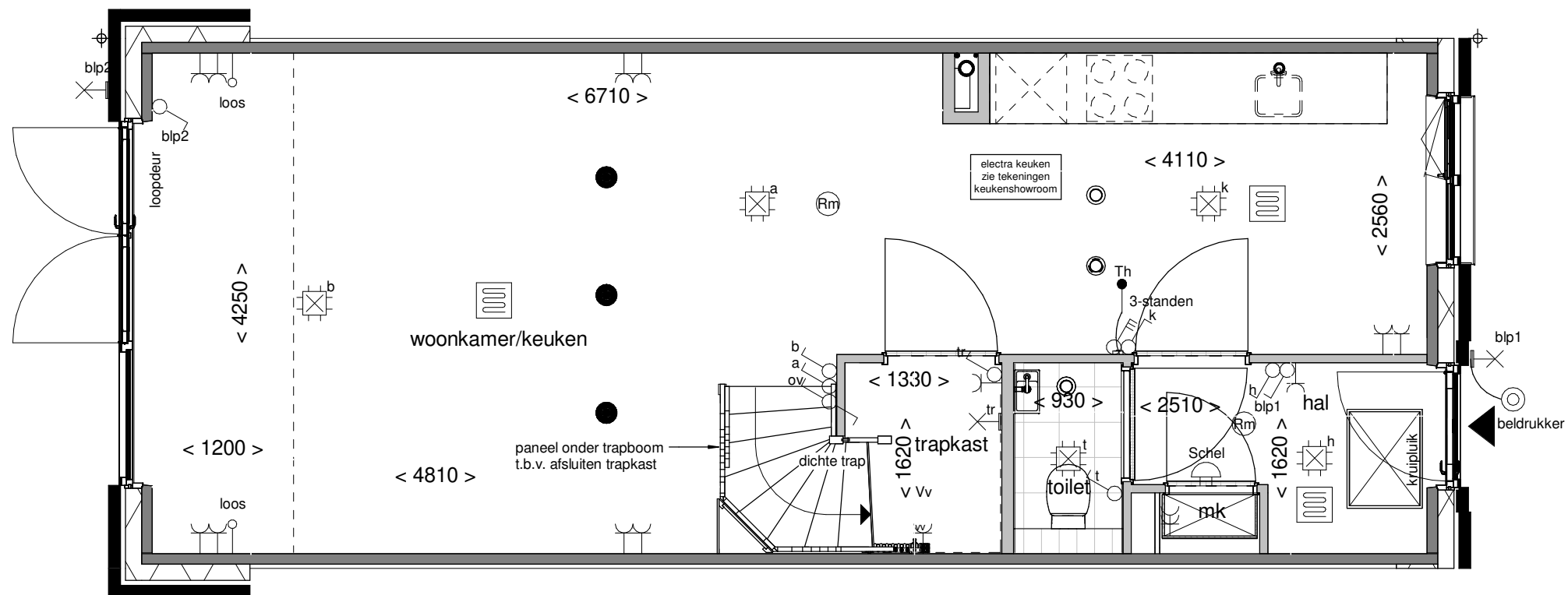

Achtergevel schaal 1:100

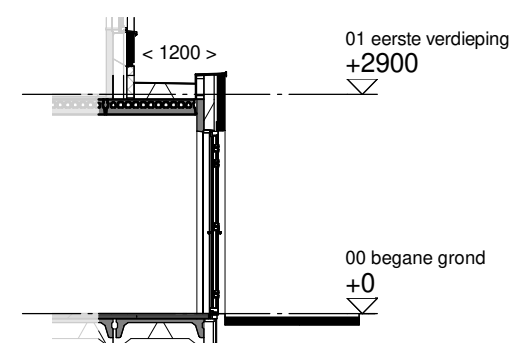

Doorsnede schaal 1:100

**ALLEMAAL
VIELEYAAL**

Optie: **Uitbouw achtergevel
1200mm**

Woningtype: **Z45**

Bouwnummer: -

Optienummer: **0.A.Z.14**

Schaal: **1:50 / 1:100**

Datum: **30-01-2024**

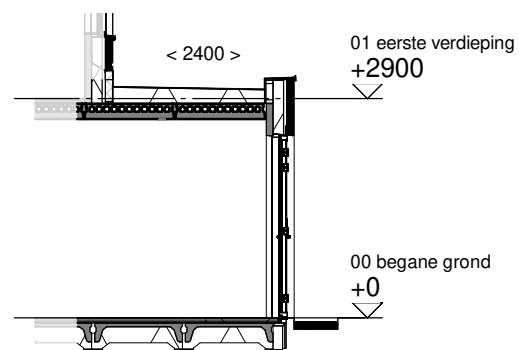
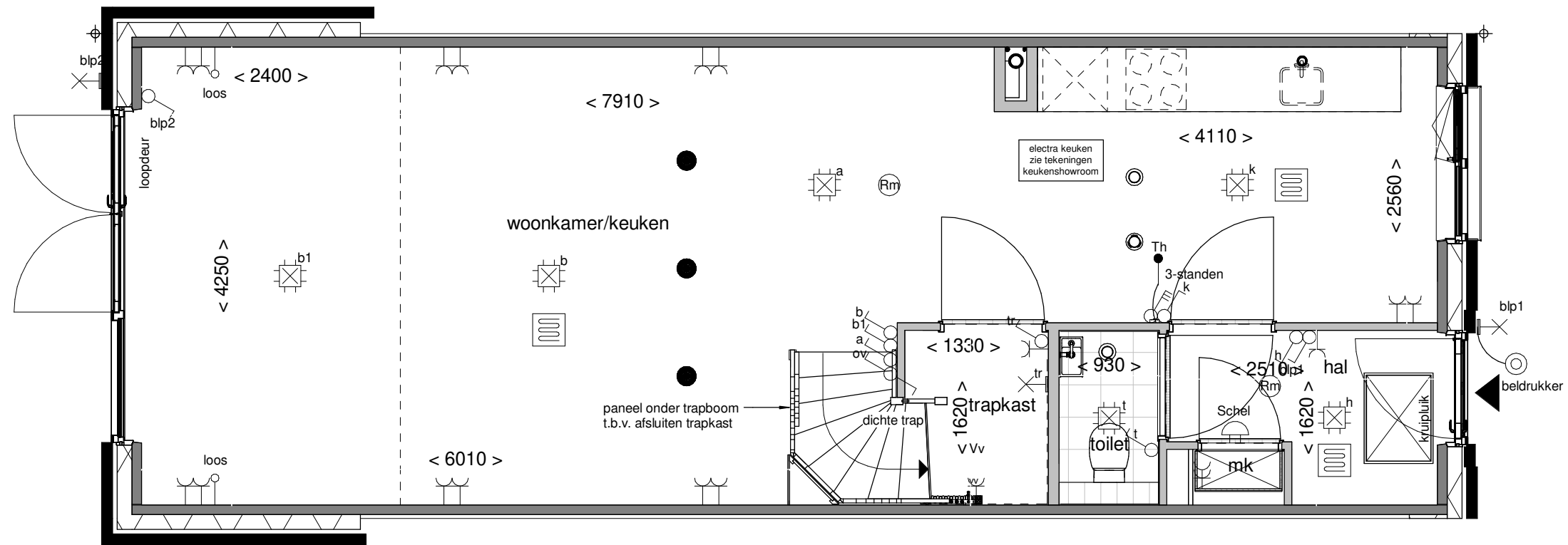

Doorsnede schaal 1:100



Achtergevel schaal 1:100

**ALLEMAAL
VIELEYAAL**

Optie: Uitbouw achtergevel
2400mm

Woningtype: Z45

Bouwnummer: -

Optienummer: 0.A.Z.34

Schaal: 1:50 / 1:100

Datum: 30-01-2024

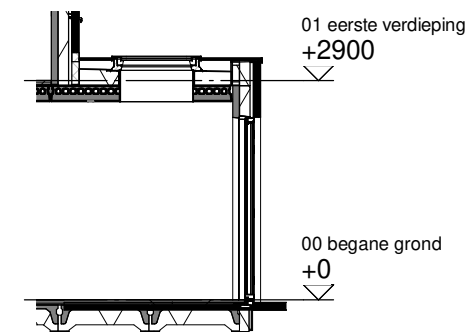
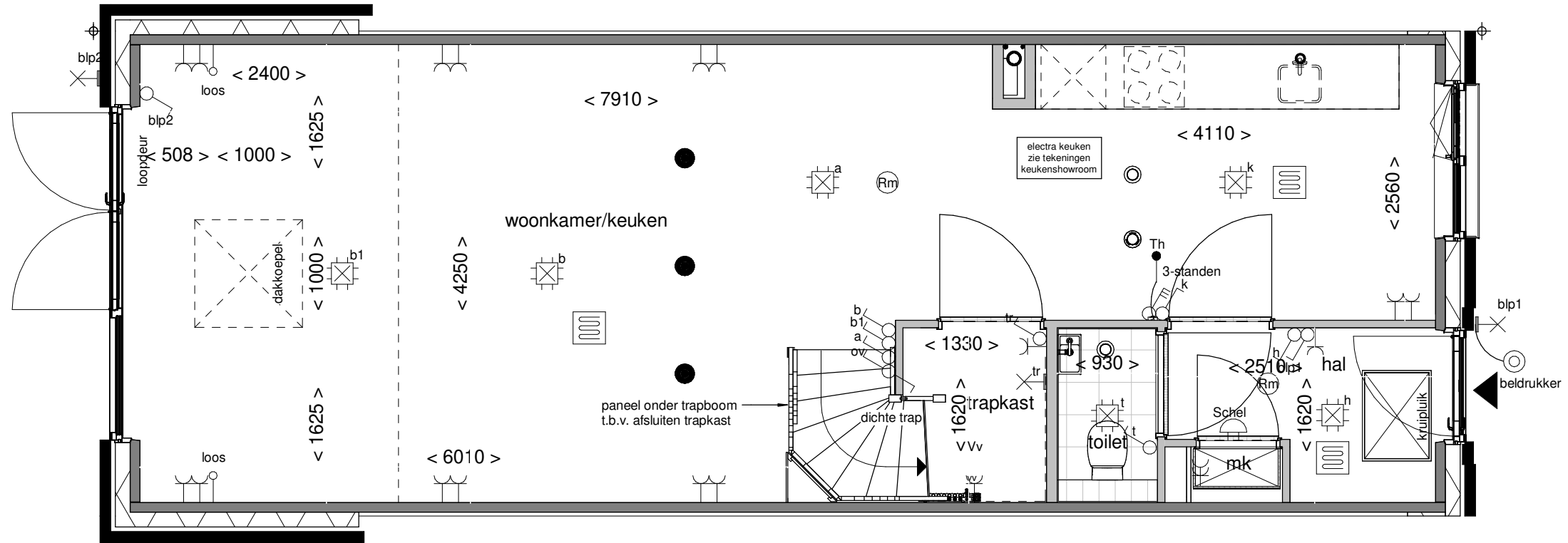

Doorsnede schaal 1:100

**ALLEMAAL
VIELEYAAL**

Optie: Lichtkoepel in uitbouw 2400mm

Woningtype: Z45

Bouwnummer: -

Optienummer: 1.B.X.10

Schaal: 1:50 / 1:100

Datum: 30-01-2024

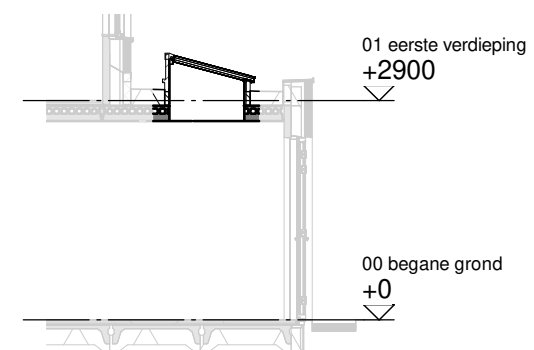
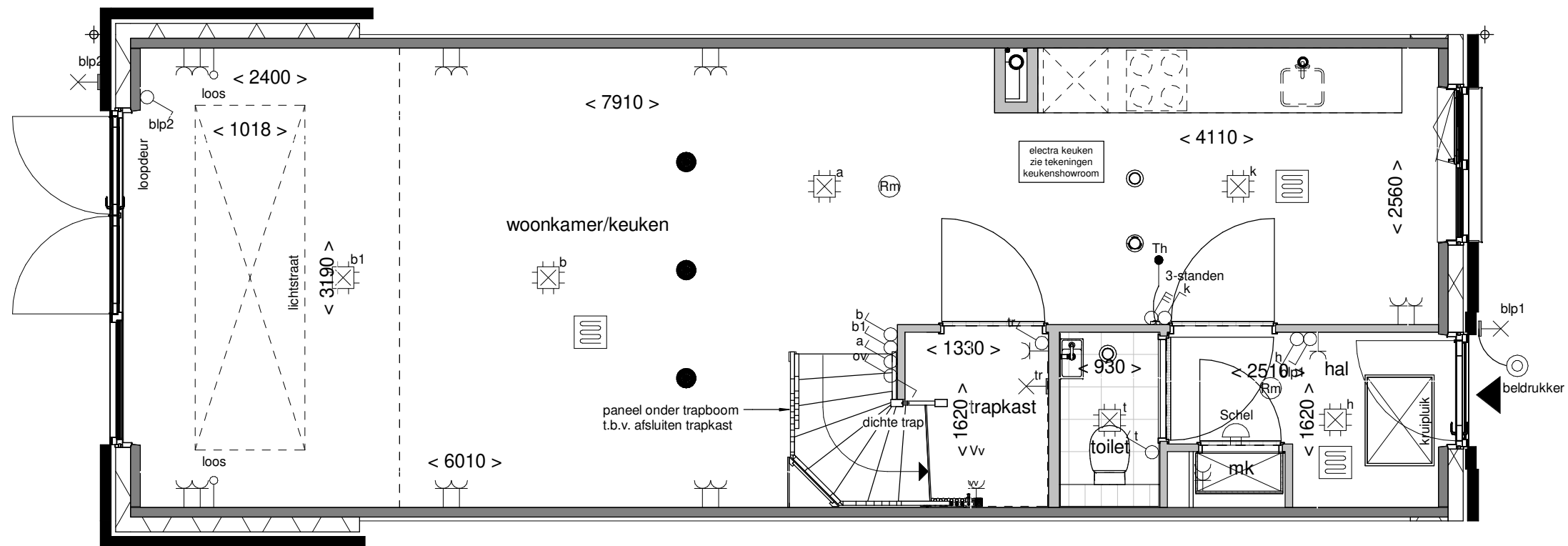

Doorsnede schaal 1:100

**ALLEMAAL
YIELEYAAL**

Optie: Lichtstraat in uitbouw
2400mm

Woningtype: Z45

Bouwnummer: -

Optienummer: 1.B.X.14

Schaal: 1:50 / 1:100

Datum: 30-01-2024

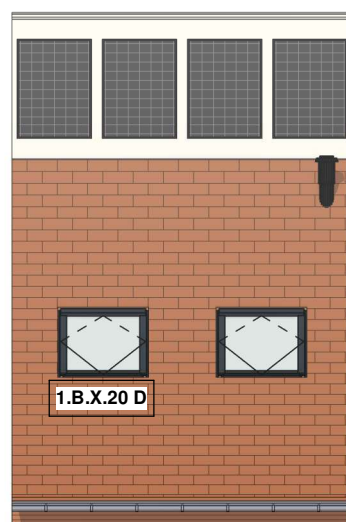
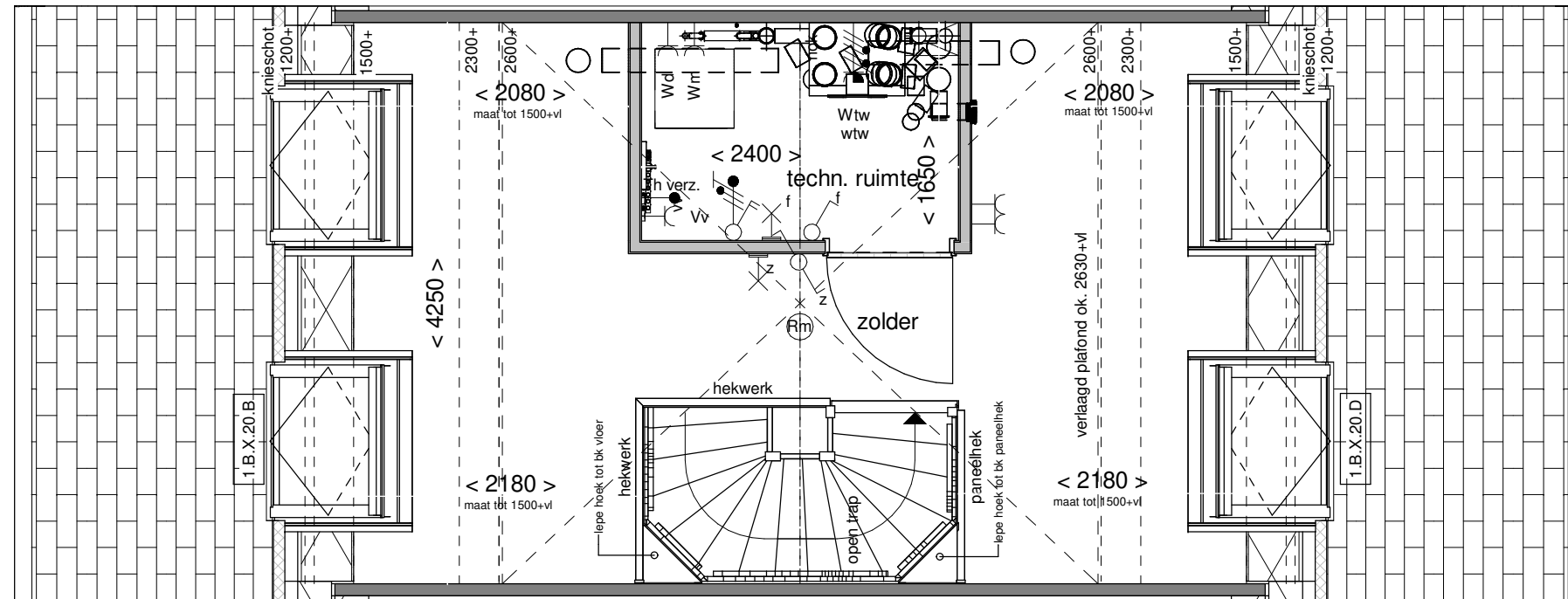

Voorgevel schaal 1:100

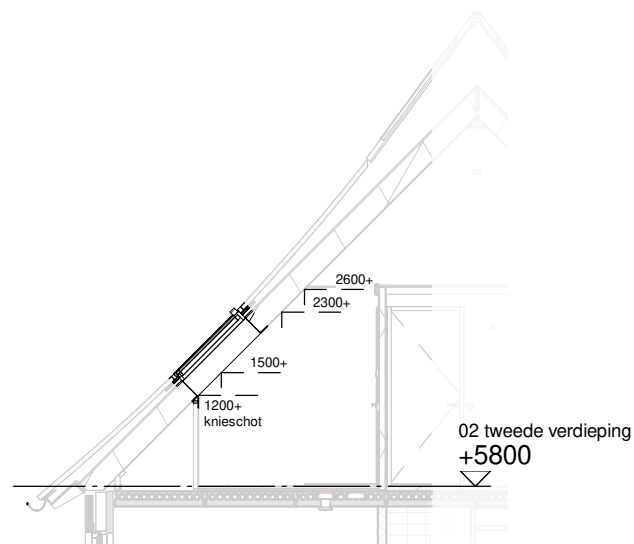

Doorsnede schaal 1:100

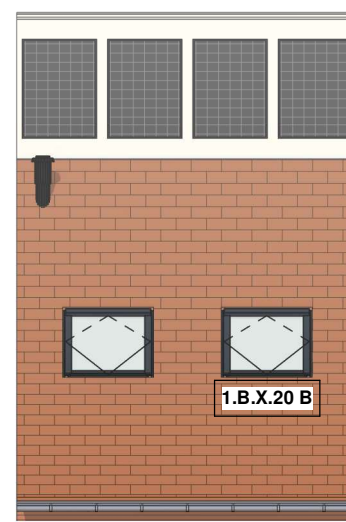

Achtergevel schaal 1:100

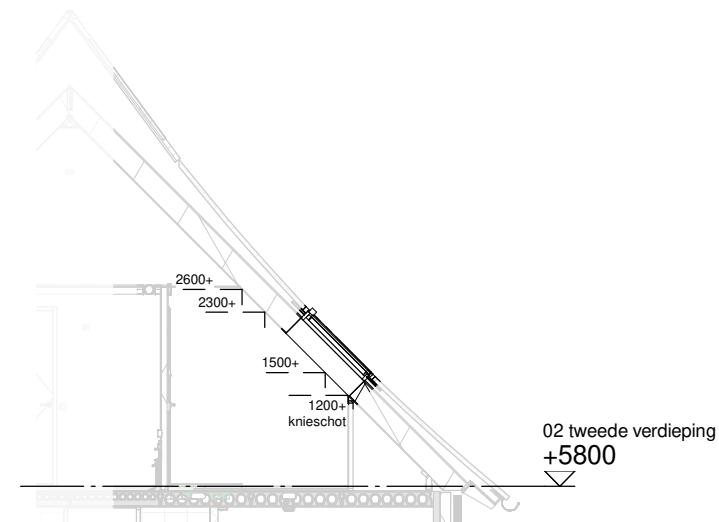

Doorsnede schaal 1:100

**ALLEMAAL
YIELEYAAL**

Optie: Dakramen voor- en achtergevel

Woningtype: Z45

Bouwnummer: -

Optienummer: 1.B.X.20

Schaal: 1:50 / 1:100

Datum: 30-01-2024

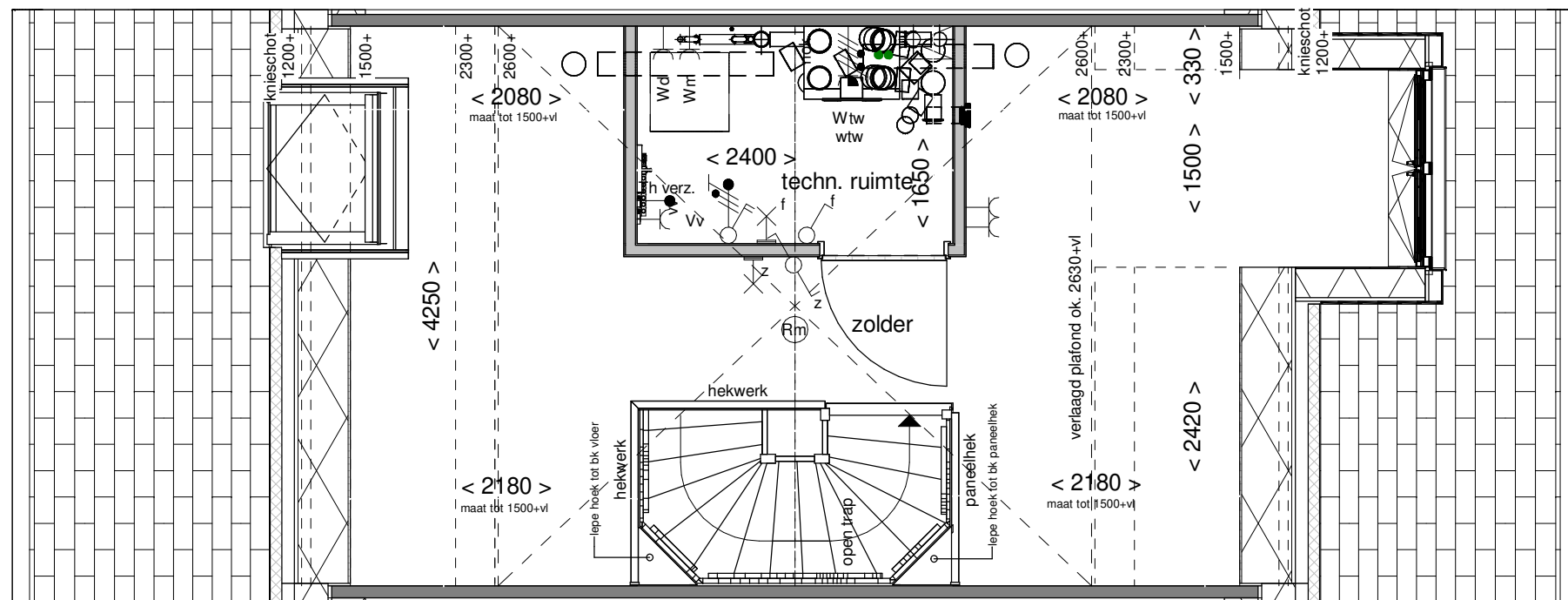

Voorgevel schaal 1:100

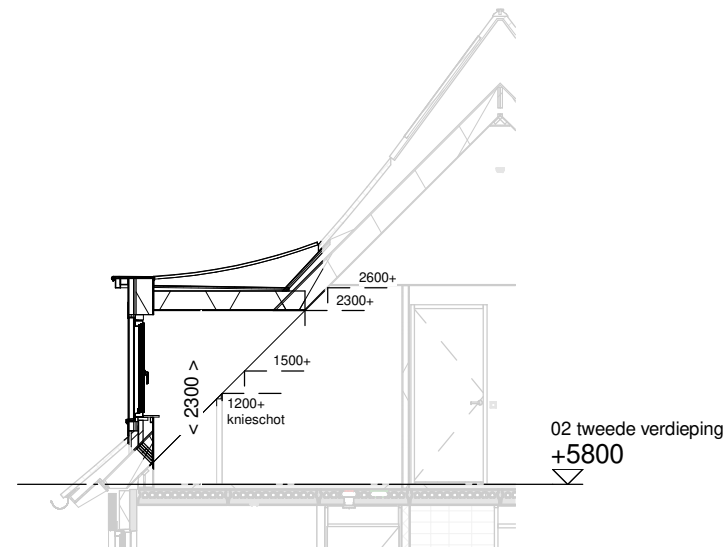

Doorsnede schaal 1:100

**ALLEMAAL
VIELEYAAL**

Optie: Dakkapel
voorgevel 1500mm

Woningtype: Z45

Bouwnummer: -

Optienummer: 1.B.X.33

Schaal: 1:50 / 1:100

Datum: 30-01-2024

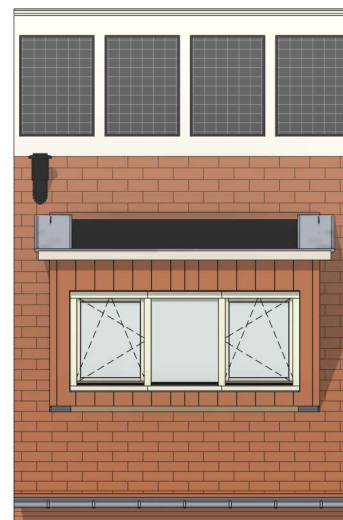
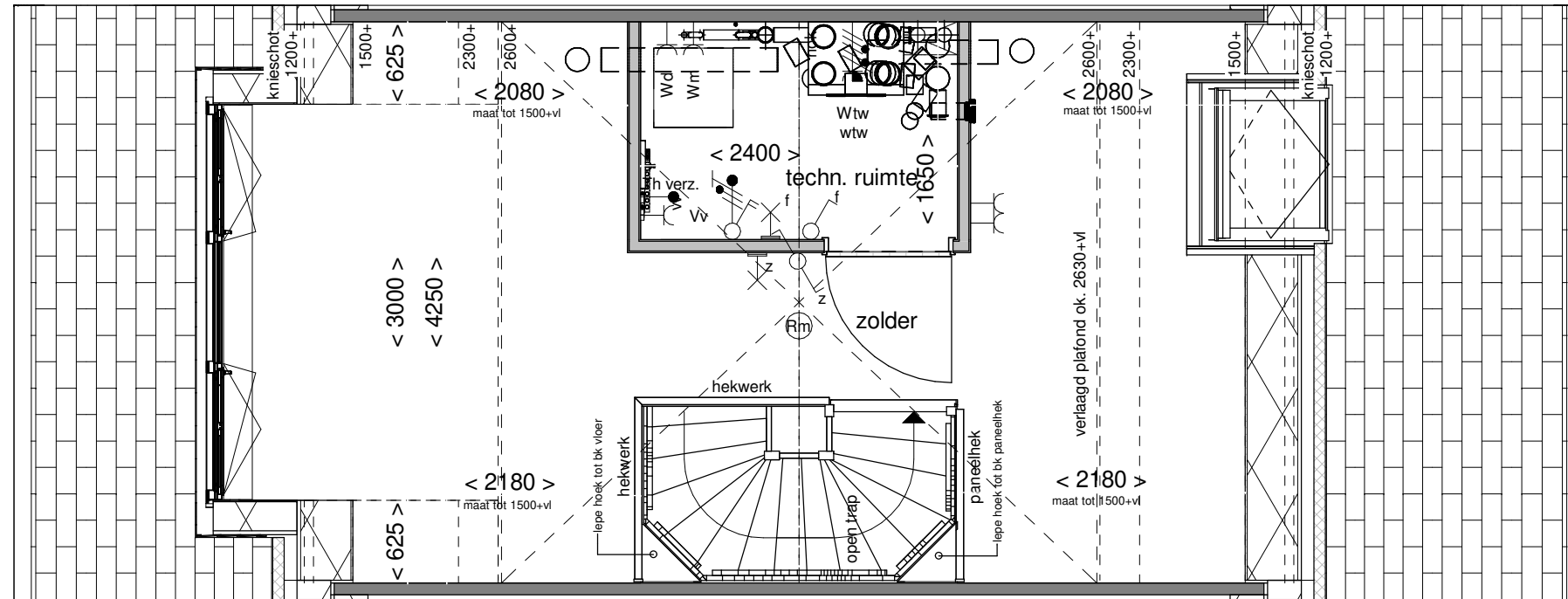

Achtergevel schaal 1:100

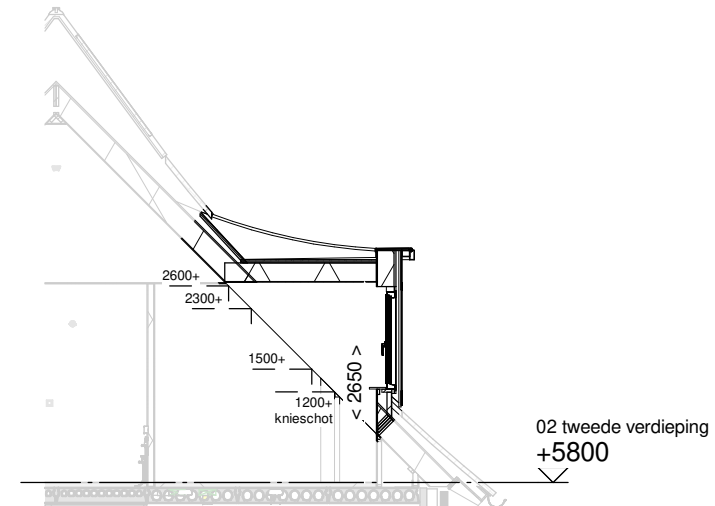

Achtergevel schaal 1:100

**ALLEMAAL
VIELEYAAL**

Optie: Dakkapel
achtergevel 3000mm

Woningtype: Z45

Bouwnummer: -

Optienummer: 1.B.X.34

Schaal: 1:50 / 1:100

Datum: 30-01-2024

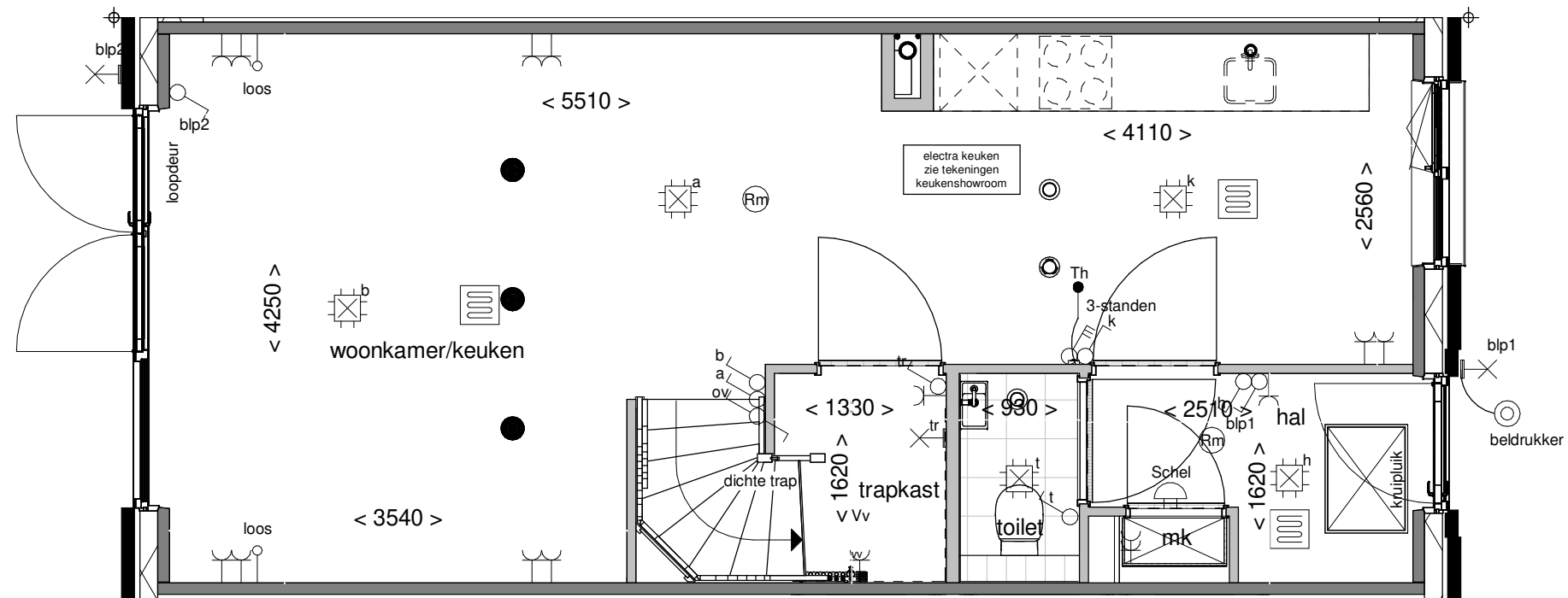

**ALLEMAAL
YIELEYAAL**

Optie: Wand naast trap

Woningtype: Z45

Bouwnummer: -

Optienummer: 1.C.Z.10

Schaal: 1:50

Datum: 30-01-2024

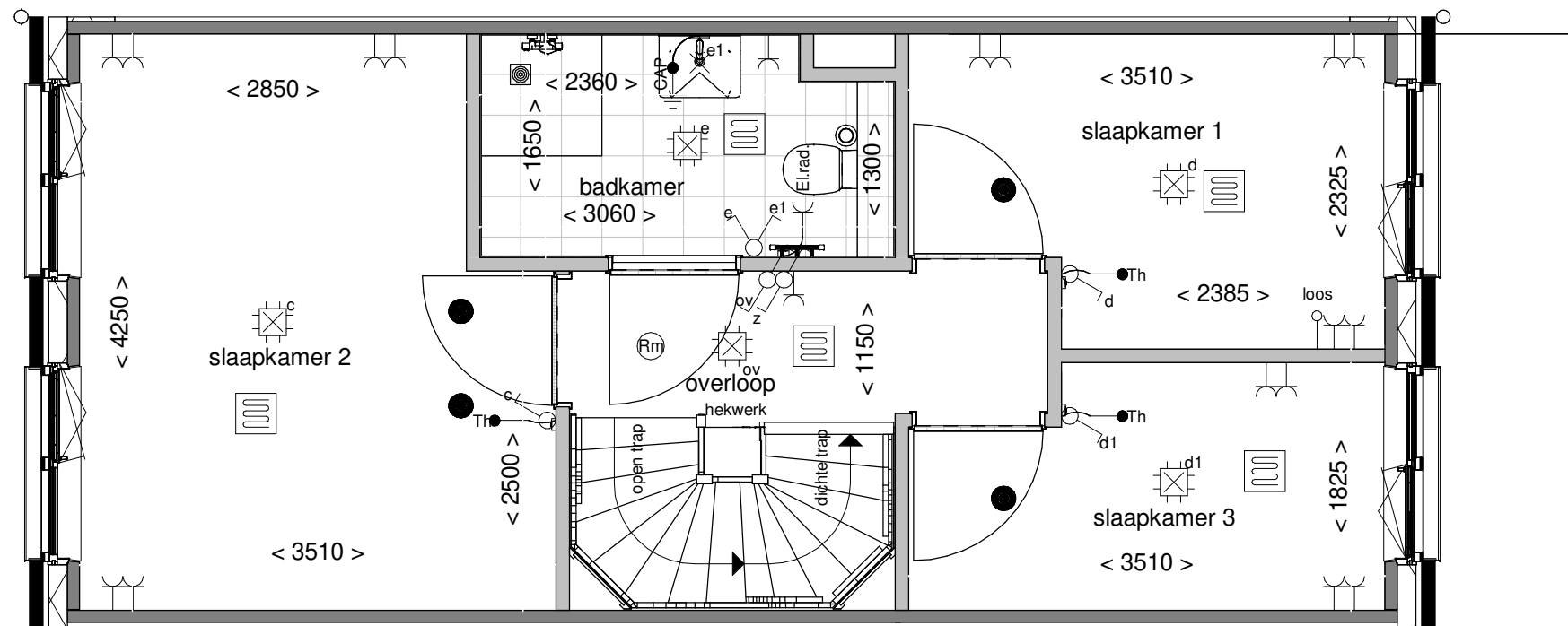

**ALLEMAAL
VIELEYAAL**

Optie: Twee slaapkamers
voorzijde

Woningtype: Z45

Bouwnummer: -

Optienummer: 1.C.Z.36

Schaal: 1:50

Datum: 30-01-2024

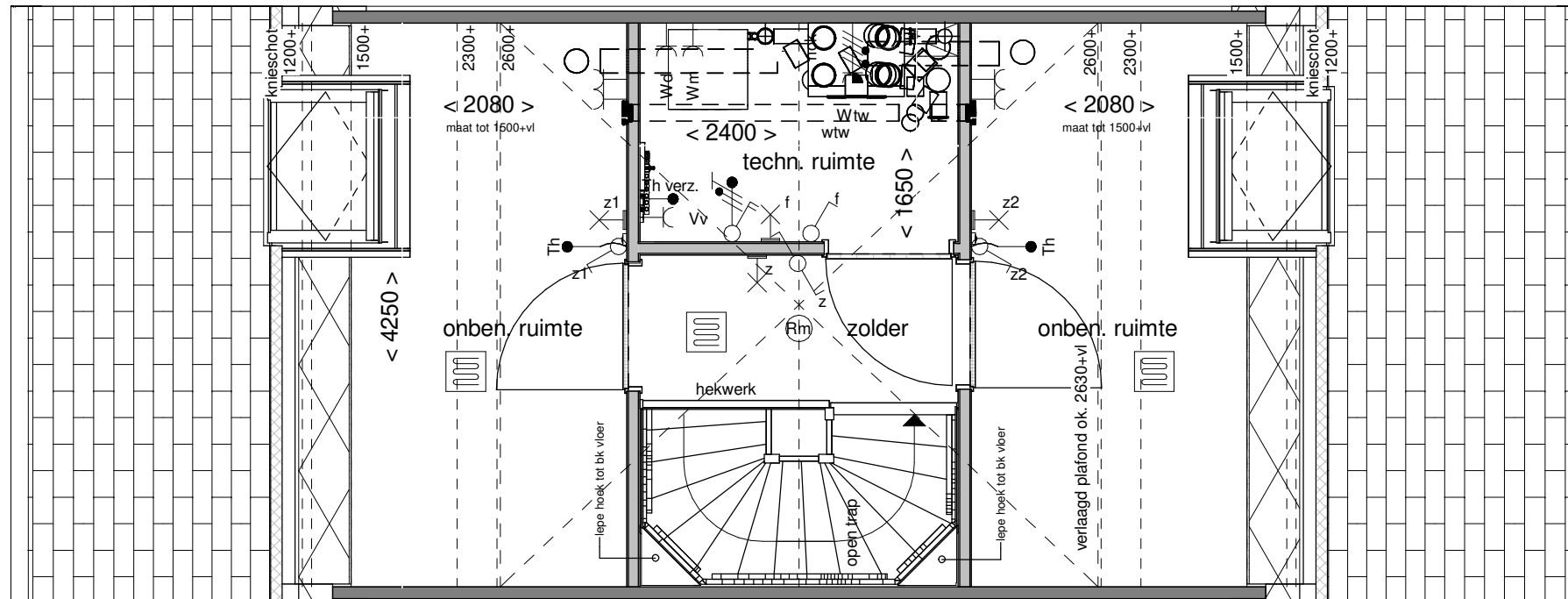

**ALLEMAAL
VIELEYAAL**

Optie: Indeling techn.- en
2 onb. ruimtes

Woningtype: Z45

Bouwnummer: -

Optienummer: 1.C.Z.76

Schaal: 1:50

Datum: 30-01-2024